

User's Guide



<http://www.omega.com>
[e-mail: info@omega.com](mailto:info@omega.com)

OMB-TEMPSCAN-1100
OMB-MULTISCAN-1200

**High Speed Temperature
& Voltage Systems**



OMEGAnetSM On-Line Service http://www.omega.com	Internet e-mail info@omega.com
---	--

Servicing North America:

USA: One Omega Drive, Box 4047
ISO 9001 Certified Stamford, CT 06907-0047
Tel: (203) 359-1660 FAX: (203) 359-7700
e-mail: info@omega.com

Canada: 976 Berger
Laval (Quebec) H7L 5A1
Tel: (514) 856-6928 FAX: (514) 856-6886
e-mail: canada@omega.com

For immediate technical or application assistance:

USA and Canada: Sales Service: 1-800-826-6342 / 1-800-TC-OMEGASM
Customer Service: 1-800-622-2378 / 1-800-622-BESTSM
Engineering Service: 1-800-872-9436 / 1-800-USA-WHENSM
TELEX: 996404 EASYLINK: 62968934 CABLE: OMEGA

Mexico and Latin America: Tel: (95) 800-TC-OMEGASM FAX: (95) 203-359-7807
En Espanol: (95) 203-359-7803 e-mail: espanol@omega.com

Servicing Europe:

Benelux: Postbus 8034, 1180 LA Amstelveen, The Netherlands
Tel: (31) 20 6418405 FAX: (31) 20 6434643
Toll Free in Benelux: 06 0993344
e-mail: nl@omega.com

Czech Republic: ul. Rude armady 1868
733 01 Karvina-Hranice
Tel: 420 (69) 6311899 FAX: 420 (69) 6311114
e-mail: czech@omega.com

France: 9, rue Denis Papin, 78190 Trappes
Tel: (33) 130-621-400 FAX: (33) 130-699-120
Toll Free in France: 0800-4-06342
e-mail: france@omega.com

Germany/Austria: Daimlerstrasse 26, D-75392 Deckenpfronn, Germany
Tel: 49 (07056) 3017 FAX: 49 (07056) 8540
Toll Free in Germany: 0130 11 21 66
e-mail: germany@omega.com

United Kingdom: 25 Swannington Road, P.O. Box 7, Omega Drive,
ISO 9002 Certified Broughton Astley, Leicestershire, Irlam, Manchester,
LE9 6TU, England M44 5EX, England
Tel: 44 (1455) 285520 Tel: 44 (161) 777-6611
FAX: 44 (1455) 283912 FAX: 44 (161) 777-6622

Toll Free in England: 0800-488-488

e-mail: uk@omega.com

It is the policy of OMEGA to comply with all worldwide safety and EMC/EMI regulations that apply. OMEGA is constantly pursuing certification of its products to the European New Approach Directives. OMEGA will add the CE mark to every appropriate device upon certification.

The information contained in this document is believed to be correct but OMEGA Engineering, Inc. accepts no liability for any errors it contains, and reserves the right to alter specifications without notice.

WARNING: These products are not designed for use in, and should not be used for, patient connected applications.

Introduction to this Manual

This manual supersedes previous revisions of the *TempScan/1100 User's Manual* and the *MultiScan/1200 User's Manual*. The material in this manual discusses specific high-speed temperature and voltage instruments and their accompanying Windows-based application software. This material is divided into the following sections:

Section I: System Overview

- **Chapter 1: System Overview** gives a general description of both the hardware and software products available for the TempScan/1100 or MultiScan/1200 system. The hardware products discussed include not only the master units, but also their related expansion units, their optional scanning cards, and their accessories. The software products discussed include the Windows-based applications TempView, PostView, ScanCal, and third-party software accessories.

Section II: Hardware Guides

This section gives a more-detailed description of each of the hardware products available for the TempScan/1100 or MultiScan/1200 system.

- **Chapter 2: TempScan/1100 & MultiScan/1200** provides a detailed discussion of the master units, their features, front and rear panel descriptions, and necessary hardware configurations. Both IEEE 488 and RS-232/RS-422 interfaces are covered.
- **Chapter 3: Exp/10A Expansion Unit** provides a detailed discussion of this two-slot expansion unit, its features, front and rear panel descriptions, and necessary hardware configurations.
- **Chapter 4: Exp/11A Expansion Unit** provides a detailed discussion of this ten-slot expansion unit, its features, front and rear panel descriptions, and necessary hardware configurations.
- **Chapter 5: TempScan/1100 Scanning Cards** discusses the three scanning card options available to the TempScan/1100 unit: The TempTC/32B thermocouple scanning card, the TempV/32B volts scanning card, and the TempRTD/16B RTD scanning card.
- **Chapter 6: MultiScan/1200 Scanning Cards** discusses the two scanning card options available to the MultiScan/1200 unit: The MTC/24 thermocouple/volt scanning card and the MHV/24 high-voltage scanning card.
- **Chapter 7: Power & Assembly** provides detailed instructions on line-voltage selection and fuse replacement, rack-mount and bench-top installation, as well as power-up activation.

Section III: Software Guides

This section gives a more-detailed description of each of the software products included with the TempScan/1100 or MultiScan/1200 package.

- **Chapter 8: ChartView** discusses the ready-to-use Windows-based data-logging software that features the stripchart-style graphical interface designed for users new to this kind of software, and for users with more-powerful less-resource-limited PC systems. The various windows, toolbar buttons and menu items are described and explained.
- **Chapter 9: TempView** discusses the ready-to-use Windows-based data-logging software that features the spreadsheet-style graphical interface designed for users already familiar with earlier versions of TempView, and for users with less-powerful resource-limited PC systems. The various windows, toolbar buttons and menu items are described and explained.
- **Chapter 10: PostView** discusses the Windows-based post-acquisition data-viewing software which comes as a companion to the ChartView or TempView software. The various display features of this viewing program are described and explained.
- **Chapter 11: ScanCal** discusses the Windows-based auto-calibration software which also comes as a companion to the ChartView or TempView software. The easy-to-use features of this program are described and explained.

Section IV: Theory & Programming Guides

For experts who prefer to program, this section gives a more theory-oriented and programming-oriented explanation of the system operations involved with the TempScan/1100 or MultiScan/1200 unit. Although originally written for QuickBASIC, the following chapters apply to all programming languages and computers.

- **Chapter 12: System Configuration** discusses TempScan/1100 or MultiScan/1200 memory allocation, the required configuration of channels, scans, acquisitions, and triggers, as well as the additional configuration of alarms, data format, and power-up.
- **Chapter 13: System Operation** discusses how the TempScan/1100 or MultiScan/1200 system operates, including the operation of the acquisition buffer, the digital input/output, the High/Low/Last (HLL) Registers, the Status and Event Reporting Registers, as well as the channels.
- **Chapter 14: System Calibration** discusses the traditional manual method of calibration for the TempScan/1100 and MultiScan/1200 units, and for their respective scanning cards.
- **Chapter 15: Program Examples** discusses ten program examples that are supplied on the release disk(s). Typical tasks are covered, including data acquisition and alarm control.

Section V: API Command Reference

- **Chapter 16: API Command Reference** discusses the entire command set covering both the TempScan/1100 and MultiScan/1200 units. The command syntax, interpretation, and reference are provided. The description format of the individual API commands includes the command type, execution, syntax, description, and an example program excerpt.

Appendix

- The **Appendix** provides background information concerning the IEEE 488 bus, the serial bus, and ASCII controls.

Index

- The **Index** provides a comprehensive alphabetical listing of the main terms and topics in this manual. Also, the **Abbreviations** on the last pages of this manual, provides an overall list of abbreviations, including acronyms and ASCII control codes, as an additional reference for this manual and for other related literature.

Information which may have changed since the time of printing will be found in a **README.TXT** file on disk, or in an addendum to the manual.

Table of Contents

1 - System Overview

Hardware Products 1

TempScan/1100.....1
MultiScan/1200.....1
Exp/10A Expansion Unit.....2
Exp/11A Expansion Unit.....2
TempScan/1100 Scanning Cards.....2
MultiScan/1200 Scanning Cards.....2
Hardware Accessories.....3

Hardware Connections 4

IEEE 488 Connection from PC to Master Unit.....4
Serial Connection from PC to Master Unit.....4
Master/Slave Connection from TempScan/1100 to Expansion Unit.....5
Master/Slave Connection from MultiScan/1200 to Expansion Unit.....5
Disconnecting & Reconnecting the System During Setup.....6

Software Products 9

ChartView.....9
TempView.....9
PostView.....9
ScanCal.....9

2 TempScan/1100 & MultiScan/1200

Introduction 11

The Package.....11
Front Panel Indicators.....12
Rear Panel Switches & Connectors.....13
TempScan/1100 & MultiScan/1200 Specifications.....14

Hardware Configuration 17

IEEE 488 Configuration.....18
RS-232/RS-422 Configuration.....18
Calibration Protection Configuration.....23
Digital I/O Configuration.....23
TTL Output & Trigger Input Configuration.....24
Expanded Memory Configuration.....25
Scanning Card & Channel Expansion.....26

3 Exp/10A Expansion Unit

Introduction 27

The Package.....27
Front Panel Indicators.....27
Rear Panel Switches & Connectors.....28
Exp/10A Specifications.....29

Hardware Configuration 30

Master/Slave Connection.....30
Slave Configuration.....31
Channel Assignment.....31

4 Exp/11A Expansion Unit

Introduction 33

The Package.....33
Front Panel Indicators.....33

Rear Panel Switches & Connectors.....34
Exp/11A Specifications.....35

Hardware Configuration 36

Master/Slave Connection.....36
Slave Configuration.....37
Channel Assignment.....37

5 TempScan/1100 Scanning Cards

Introduction 39

TempTC/32B Thermocouple Scanning Card 40

TempTC/32B Specifications.....40
TempTC/32B Description.....41

TempV/32B Voltage Scanning Card 42

TempV/32B Specifications.....42
TempV/32B Description.....43

TempRTD/16B RTD Scanning Card 44

TempRTD/16B Specifications.....44
TempRTD/16B Description.....44

6 MultiScan/1200 Scanning Cards

Introduction 45

MTC/24 Thermocouple/Volt Scanning Card 46

MTC/24 Specifications.....46
MTC/24 Description.....47

MHV/24 High-Voltage Scanning Card 48

MHV/24 Specifications.....48
MHV/24 Description.....48

7 Power & Assembly

Power Line & Fuse Configuration 49

Introduction.....49
Line Voltage Selection.....50
Fuse Replacement.....52

Rack-Mount & Bench-Top Assembly 53

Rack Mount.....53
Bench Top.....53

Power-Up Activation 54

8 ChartView & ChartView Plus

Introduction 55

Groups, Charts & Channels.....56
Using ChartView.....56
What ChartView Provides.....58

ChartView Main Window 58

Channel Information Region.....60
Status Indicator Region.....61

Main Window Toolbar 62

Group Select.....62
Start, Pause & Stop Charts.....62
Scroll Faster & Scroll Slower.....63
Display Configuration Setup.....63
Channel Configuration.....69
PostView post-acq data viewer.....69
Arm Acquisition.....69

Disarm.....	69
Print Charts.....	70
Main Window Pull-Down Menus	70
File Menu.....	70
Chart Menu.....	71
View Menu.....	72
Acquire Menu.....	73
Data Menu.....	73
Window Menu.....	75
Device > Interface >.....	76
Device > Status >.....	77
Device > Configuration >.....	79
Setup Menu.....	79
Bar Graph, Analog & Digital Meters	80
Overview.....	80
Bar Graph Meters.....	80
Analog Meters.....	81
Digital Meters.....	82
Meters Toolbars.....	83
Meters Pull-Down Menus.....	83
Meters Configuration Menu.....	84
Configuring a Meter.....	84
Setup Window	85
Channel & Alarm Setup Dialog Box.....	85
Acquisition Setup Dialog Box.....	88
Data Destination Dialog Box.....	91
Chart Setup Wizard	93
Introduction.....	93
Automatic Chart Creation.....	94
Bypassing Automatic Chart Creation.....	95

9 TempView

Introduction	97
Default Configuration File.....	97
TempView Installation, Startup & Setup	98
TempView Main Window	102
Channel Configuration Area.....	103
Status Area.....	107
System State Area.....	107
File Menu Items.....	108
Edit Menu Items.....	110
Acquire Menu Items.....	111
Data Menu Items.....	117
Window Menu Items.....	121
Device Menu Items.....	122
Device Menu Items (Expanded).....	125
Alarms Menu Items.....	127
TempView Charts & Meters Windows	129
Channel Display Area.....	132
Control Menu Items (Charts & Meters).....	133
Speed Menu Items (Charts Only).....	134
Options Menu Items (Charts Only).....	135
View Menu Items (Meters Only).....	136
Configure Meter Pop-Up Menu Items (Meters Only).....	137

10 PostView

Introduction	141
Starting PostView	143

Toolbar	144
Channel Information Region	145
Pull-Down Menus	146
File Menu.....	146
Go To Menu.....	146
Options Menu.....	146
Help Menu.....	146
Groups, Charts & Channels	147
Chart Setup Wizard	147
Introduction.....	147
Automatic Chart Creation.....	148
Display Configuration Setup	149
Editing a Display.....	150
Manually Creating a Display.....	152
PostView Timebase	155
Data File Accessibility	155

11 ScanCal

Introduction	157
Calibration Setup	157
Calibration Properties.....	157
Calibration Protection.....	158
ScanCal Main Window	159
Inventory Display Area.....	160
Instructions Area.....	160
File Menu Items.....	161
Instrument Menu Items.....	162
Calibrate Menu Items.....	163

12 System Configuration

Introduction	165
Memory Allocation	166
Measuring Modes (MultiScan/1200 Only)	166
Line-Cycle Integration / High-Speed Multi-Channel Mode.....	167
Single-Channel High-Speed Burst Mode.....	169
Required Configuration	170
Channel Configuration.....	171
Scan Configuration.....	173
Acquisition Configuration.....	177
Trigger Configuration.....	180
Additional Configuration	182
Alarm Configuration.....	183
Stamp Configuration.....	186
Data Format Configuration.....	190
Power-Up Configuration.....	196

13 System Operation

Acquisition Buffer	197
Buffer Organization.....	198
Buffer Query Operation.....	199
Buffer Read Operations.....	201
Buffer Overrun.....	207
High/Low/Last (HLL) Registers	209
Contents of the HLL Registers.....	209
Access to the HLL Registers.....	209

Comparing Buffered Data to HLL Data.....	214
Status-Reporting & Mask Registers	214
Theory of Operation.....	215
Status-Reporting Registers.....	216
Mask Registers.....	220
Using Status-Reporting Registers.....	220
Additional Operation	222
Trigger Latency.....	222
Real-Time Clock.....	222
Open Thermocouple & Range Error Checking.....	223
Software Digital Filtering (TempScan/1100 Only).....	223

14 System Calibration

Introduction	225
Calibration Setup	225
Calibration Properties.....	225
Calibration Protection.....	226
Calibration Status.....	226
Calibration Password.....	227
Calibration of Master Chassis	228
Calibration of Scanning Cards	230
Calibration of Thermocouple Scanning Cards.....	232
Calibration of Voltage Scanning Cards.....	236
Calibration of RTD Scanning Cards.....	237

15 Program Examples

Introduction	239
Reading HLL Status	240
Reading HLL Data from Thermocouple & Volts Cards	242
Acquiring Pre- & Post-Trigger Data at Different Rates	244
Acquiring Pre- & Post-Trigger Data at the Same Rate	248
Operating Alarms	252
Using the IEEE 488 SRQ with Alarms	256
Acquiring Buffer Data in Binary Format	260
Acquiring HLL Data in Binary Format	264
Using Auto Re-arm to Capture Multiple Trigger Blocks	268
Acquiring Burst Mode Data (MultiScan/1200 Only)	272

16 API Command Reference

Introduction	276
Command Syntax.....	276
Command Interpretation.....	277
Command Summary.....	280
Command Reference	285
Command Description Format.....	285
The Commands.....	285

@ - Trigger On Command.....	286
*B - Flush Acquisition Buffer.....	287
*C - Clear Channel Configuration.....	288
*F - Restore Factory Settings.....	289
*G - Set RTD Gain Calibration Reference.....	290
*K - Change Calibration Keyword.....	291
*P - Adjust Calibration Card Pots.....	292
*R - Reset Power-On.....	293
*S - Set Power-Up Configuration.....	294
*T - Set Scan Time Stamping.....	295
*W - Set Software Digital Filtering.....	296
A - Assign Alarm Output.....	297
A# - Set Scan Alarm Stamping.....	298
C - Configure Channels.....	299
C# - Select Cards.....	302
D# - Set Relay Make Time.....	303
E - End Calibration Mode.....	304
E? - Query Error Status.....	305
F - Set Data Format.....	306
F# - Set Burst Mode Frequency.....	308
G - Calibrate Channel Gain.....	309
H - Calibrate Channel Offset.....	310
I - Set Scan Interval.....	311
I# - Set Digital Input Stamping.....	312
J - Calibrate Cold Junction Offset.....	313
K - Enter Calibration Mode.....	314
L - Set Trigger Level.....	315
L# - Set Scan Rate.....	316
M - Set SRQ Mask.....	317
M# - Set Measuring Mode.....	318
N - Set Event Mask.....	319
O - Set Digital Output.....	320
P - Program Trigger Times.....	321
Q - Set Query Terminator.....	322
QC? - Query Card Data.....	323
R - Read Buffered Data.....	324
R# - Read Last Readings.....	325
S - Set Real-Time Clocks.....	326
T - Set Trigger Configuration.....	327
U - User Status.....	329
V - Set User Terminator.....	332
W# - Set Averaging Weight.....	333
X - Execute.....	334
Y - Set Counts.....	335
? - Query.....	336

A Appendix

IEEE 488 Bus & Serial Bus Lines	337
IEEE 488 Bus Commands	338
ASCII Codes	339
ASCII Code Summary.....	339
ASCII Code Details.....	341

I Index

Index	347
Abbreviations	350

Hardware Products 1

- TempScan/1100.....1
- MultiScan/1200.....1
- Exp/10A Expansion Unit.....2
- Exp/11A Expansion Unit.....2
- TempScan/1100 Scanning Cards.....2
- MultiScan/1200 Scanning Cards.....2
- Hardware Accessories.....3

Hardware Connections 4

- IEEE 488 Connection from PC to Master Unit.....4
- Serial Connection from PC to Master Unit.....4
- Master/Slave Connection from TempScan/1100 to Expansion Unit.....5
- Master/Slave Connection from MultiScan/1200 to Expansion Unit.....5
- Disconnecting & Reconnecting the System During Setup.....6

Software Products 9

- ChartView.....9
- TempView.....9
- PostView.....9
- ScanCal.....9

Hardware Products

The TempScan/1100 and MultiScan/1200 are high-speed, compact, rack-mountable instruments that measure up to 992 or 744 channels of temperature or voltage, respectively. Because of their unique architecture, both instruments offer unrivaled low cost per channel. They connect to a computer via IEEE 488 or RS-232/RS-422 interfaces, or via Hayes-compatible modem, and can be disconnected from the computer for stand-alone operation.

TempScan/1100

The TempScan/1100 is well-suited for temperature and lower-voltage measurement because its solid-state scanning provides temperature readings at speeds up to 960 channels per second, an important feature in applications that require monitoring of tens or hundreds of channels.

MultiScan/1200

The MultiScan/1200 is ideal for temperature and voltage measurements that require channel-to-channel isolation. The unit provides 500 V of channel-to-channel isolation for voltage, and 200 V of channel-to-channel isolation for thermocouples. The MultiScan/1200 uses relays to provide isolation and to scan thermocouples and volts at up to 147 channels per second. The unit can also digitize waveforms on a single channel at up to 20 kHz.

Exp/10A Expansion Unit

The TempScan/1100 and MultiScan/1200 master units can each control up to fifteen Exp/10A two-slot expansion units, for a maximum of 30 additional scanning cards. The Exp/10A form factor is identical to that of either master unit. When attached to the TempScan/1100, the Exp/10A is configurable for 32 or 64 input channels, providing a total expansion capacity of up to 992 channels. When attached to the MultiScan/1200, the Exp/10A is configurable for 24 or 48 input channels, providing a total expansion capacity of up to 744 channels.

Exp/11A Expansion Unit

Alternatively, the TempScan/1100 and MultiScan/1200 master units can each control up to three Exp/11A ten-slot expansion units, for a maximum of 30 additional scanning cards. Like the Exp/10A, the Exp/11A form factor is identical to that of either master unit. When attached to the TempScan/1100, the Exp/11A provides up to 320 input channels in a compact enclosure, providing a total expansion capacity of up to 992 channels. When attached to the MultiScan/1200, the Exp/11A provides up to 240 input channels, providing a total expansion capacity of up to 744 channels.

For TempScan/1100 systems consisting of more than 96 channels, or for MultiScan/1200 systems consisting of more than 72 channels, the Exp/11A ten-slot expansion unit provides an economical and convenient solution.

TempScan/1100 Scanning Cards

The TempScan/1100 master unit and any Exp/10A and Exp/11A expansion units connected to this master unit, can each accept the following three kinds of optional solid-state scanning cards:

- TempTC/32B thermocouple scanning card
- TempV/32B voltage scanning card
- TempRTD/16B RTD scanning card

Each scanning card contains screw-terminal blocks for quick and easy input connections. A padded hold-down for restraining wires and several tie-down holes for strapping down the wires, are provided to keep wires from all the channels organized and manageable. To keep noise outside and to maintain a constant internal temperature, each scanning card fits into a shielded metal enclosure inside the master or expansion unit.

MultiScan/1200 Scanning Cards

The MultiScan/1200 master unit and any Exp/10A and Exp/11A expansion units connected to this master unit, can each accept the following two kinds of optional scanning cards:

- MTC/24 thermocouple/volt scanning card
- MHV/24 high-voltage scanning card

Like the TempScan/1100 scanning cards, each of these scanning card contains screw-terminal blocks for quick and easy input connections. A padded hold-down for restraining wires and several tie-down holes for strapping down the wires, are provided to keep wires from all the channels organized and manageable. To keep noise outside and to maintain a constant internal temperature, each scanning card fits into a shielded metal enclosure inside the master or expansion unit.

Hardware Accessories

The available hardware accessories are listed below by part number. Refer to your product catalog for details.

For TempScan/1100

- **TempTC/32B:** 32-channel thermocouple scanning card for the TempScan/1100
- **TempV/32B:** 32-channel voltage scanning card for the TempScan/1100
- **TempRTD/16B:** 16-channel RTD scanning card for the TempScan/1100
- **TempMEM1:** 1 Mbyte memory option (500K reading) for TempScan/1100
- **TempMEM4:** 4 Mbyte memory option (2 M reading) for TempScan/1100
- **TempMEM8:** 8 Mbyte memory option (4 M reading) for TempScan/1100

For MultiScan/1200

- **MTC/24:** 24-channel thermocouple/volt scanning card for the MultiScan/1200
- **MHV/24:** 24-channel high-voltage scanning card for the MultiScan/1200
- **MultiMEM1:** 1 Mbyte memory option (500K reading) for MultiScan/1200
- **MultiMEM4:** 4 Mbyte memory option (2 M reading) for MultiScan/1200
- **MultiMEM8:** 8 Mbyte memory option (4 M reading) for MultiScan/1200

Expansion Units

- **Exp/10A:** Two-slot expansion chassis accepts any combination of TempScan/1100 scanning cards in a TempScan/1100 system, or any combination of MultiScan/1200 scanning cards in a MultiScan/1200 system; and includes rack-mount kit and master/slave cable (*CA-35-1*)
- **Exp/11A:** Ten-slot expansion chassis accepts any combination of TempScan/1100 scanning cards in a TempScan/1100 system, or any combination of MultiScan/1200 scanning cards in a MultiScan/1200 system; and includes rack-mount kit and master/slave cable (*CA-35-1*)

Connector Cables

- **CA-7-3:** Shielded IEEE 488 cable, 6 ft.
- **CA-47:** PC/AT/XT serial port (9-pin and 25-pin sub D) to TempScan/1100 or MultiScan/1200 (9-pin sub D) RS-232/RS-422 cable, 6 ft.

Hardware Connections

For successful data acquisition, the TempScan/1100 or MultiScan/1200 system requires specific hardware components, which can range from the simplest configuration of one master unit with one scanning card, to the most complex configurations involving one master unit, with as many as 15 slave units and as many as 31 scanning cards.

The following diagrams depict some of the possible connections among the various hardware components.

IEEE 488 Connection from PC to Master Unit

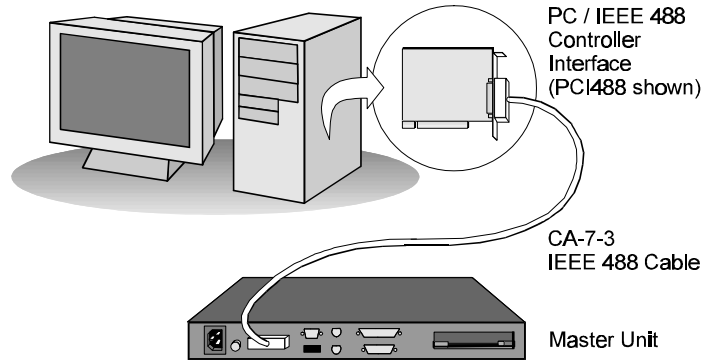

*IEEE 488 Connection
(PC to Master Unit)*

Serial Connection from PC to Master Unit

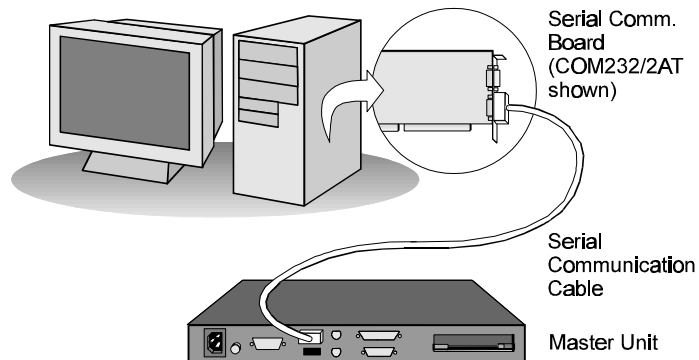

*RS-232/RS-422 Serial Connection
(PC to Master Unit)*

Master/Slave Connection from TempScan/1100 to Expansion Unit

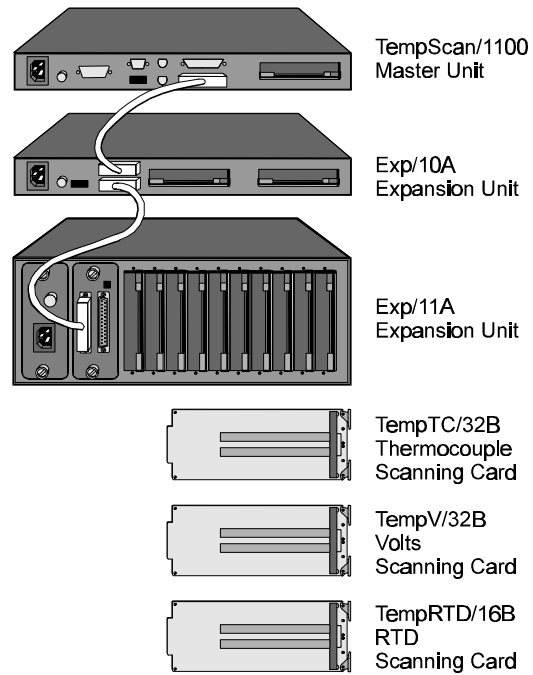

TempScan/1100 System Components

Master/Slave Connection from MultiScan/1200 to Expansion Unit

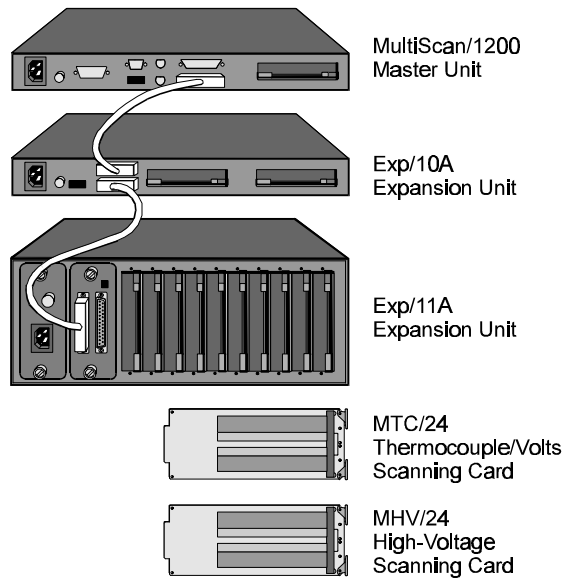

MultiScan/1200 System Components

Disconnecting & Reconnecting the System During Setup

In the following hardware chapters, the first steps of the hardware setup will require you, if system disconnections are necessary, to make these disconnections in the proper order to insure safety. Likewise, the last steps of the hardware setup will require you to make the reconnections in the proper order to insure safety, prior to reapplying power to the entire system.

Consequently, these safety steps involve the hardware disconnection of the PC, the master unit, the expansion units, the scanning cards, and any other devices attached to the system, as follows.

CAUTION



Before connecting the master unit to the PC controller interface, power down all devices that are connected or to be connected. Failure to do so could damage the equipment.

CAUTION



Before connecting an Exp/10A or Exp/11A expansion unit to its master unit, or to another expansion unit, power down all devices that are connected or to be connected. Failure to do so could damage the equipment.

CAUTION



Avoid linking two or more expansion chassis with the same slave address. Otherwise, the unspecified addresses may result in operating errors.

CAUTION



Do not mix TempScan/1100 and MultiScan/1200 scanning cards within the same system. TempScan/1100 scanning cards are designed for and supported only by the TempScan/1100 master unit. Likewise, MultiScan/1200 scanning cards are designed for and supported only by the MultiScan/1200 master unit. Otherwise, operating errors or equipment damage may occur.

WARNING



Never install or remove the scanning card from the unit while it is still connected to an external device or while the AC power is still on! Before installing the scanning card into, or removing it from, the master or expansion unit, power down all devices that are connected or to be connected. Common mode voltage potentials exceeding 60 VDC or 30 Vrms at the terminals, may exist which could cause bodily injury or death!

WARNING



Never disassemble the unit casing while it is connected to the AC power line! Internal voltage potentials exist which could cause bodily injury or death!

After your system has been connected for the first time, any disconnections of your system should be made according to the following setup cases:

- **Before changing the internal setup power line selection, fuse, or memory configuration of the master or any expansion unit(s):** Follow Steps 1 through 5 below, then proceed with Step 6.
- **Before changing the external setup DIP switch settings of the master or any expansion unit(s):** Follow Step 1 below, then proceed with Step 6.
- **Before changing or removing the scanning card(s) or input connection(s) from the system:** Follow Steps 1 through 3 below, then proceed with Step 6.
- **Before changing or removing the master unit or any expansion unit(s) from the system:** Follow Steps 1 through 5 below, then proceed with Step 6.

To Disconnect the System During Setup

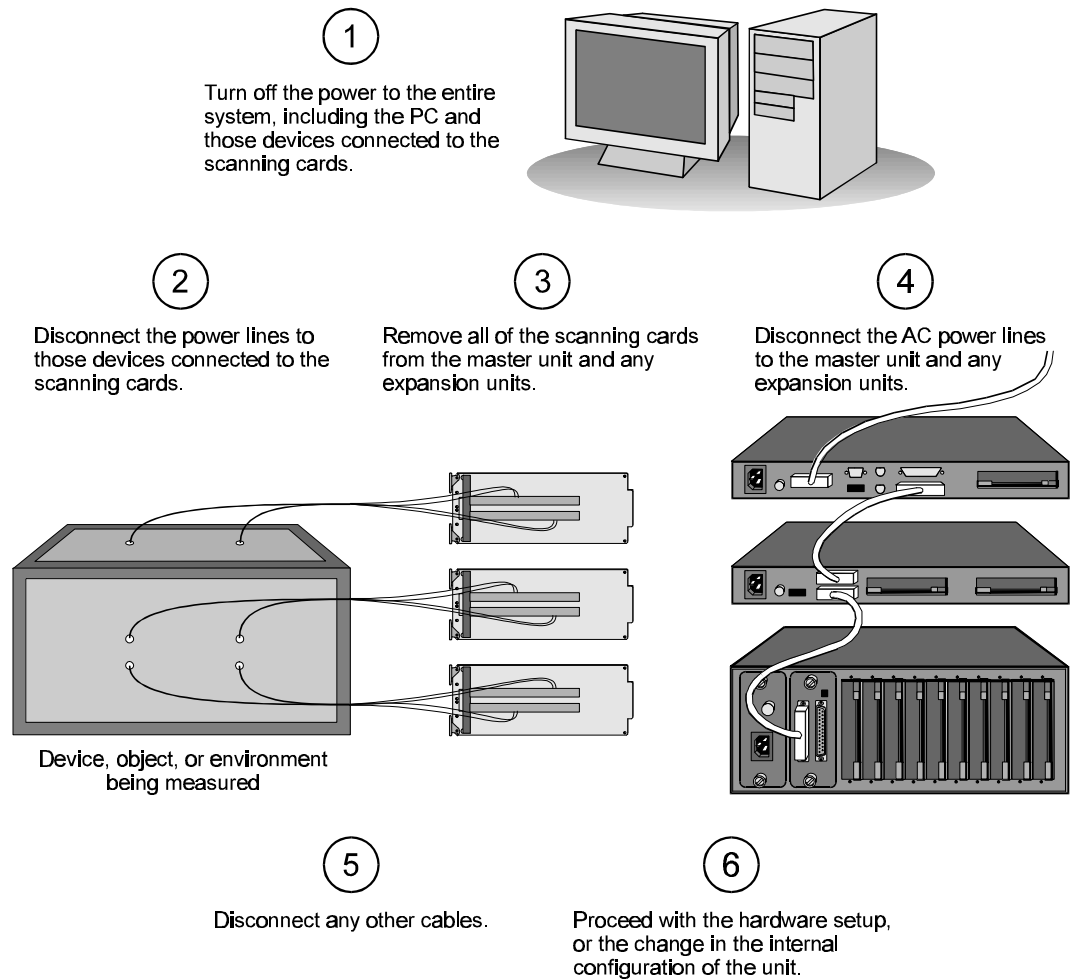

Disconnecting the System - Steps 1 through 6

When connecting your system for the first time or subsequent time thereafter, any reconnections of your system should be made according to the following setup cases:

- **After changing the internal setup power line selection, fuse, or memory configuration of the master or any expansion unit(s):** Follow Steps 7 through 11 below, then proceed with Step 12.
- **After changing the external setup DIP switch settings of the master or any expansion unit(s):** Follow Step 7 below, then proceed with Step 12.
- **After changing or removing the scanning card(s) or input connection(s) from the system:** Follow Steps 7, 9 and 10 below, then proceed with Step 12.
- **After changing or removing the master unit or any expansion unit(s) from the system:** Follow Steps 7 through 11 below, then proceed with Step 12.

To Reconnect the System During Setup

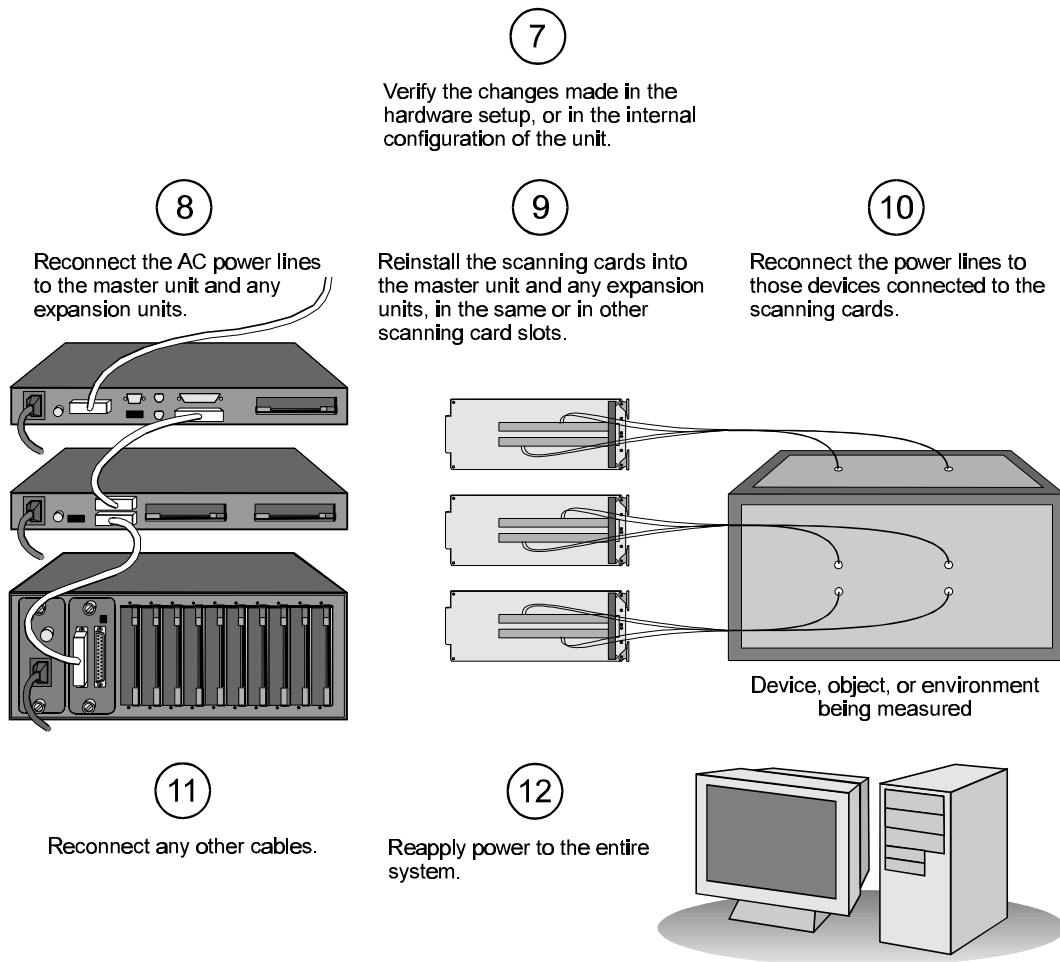

Reconnecting the System - Steps 7 through 12

Software Products

ChartView

ChartView is a Windows-based setup and acquisition application which provides a graphical stripchart-style user interface that allows the easy configuration of hardware, acquisition, and display parameters. Compatible with both Windows 3.X and Windows 95/NT, ChartView features a no-programming approach that enables data collection and display within minutes of unpacking the TempScan/1100 or MultiScan/1200. ChartView is designed for users new to this kind of software, and for users with more-powerful less-resource-limited PC systems.

TempView

TempView is a Windows-based setup and acquisition application which provides a graphical spreadsheet-style user interface that allows the easy configuration of hardware, acquisition, and display parameters. Compatible with both Windows 3.X and Windows 95/NT, TempView features a no-programming approach that enables data collection and display within minutes of unpacking the TempScan/1100 or MultiScan/1200. TempView is designed for users already familiar with earlier versions of TempView, and for users with less-powerful resource-limited PC systems.

PostView

In addition to ChartView or TempView data-logging software, each software package includes PostView, a Windows-based post-acquisition data-review program. PostView can be launched from within TempView or as a stand-alone Windows application. It provides a stripchart recorder-like graphical display for scrolling through previously acquired data files. PostView also allows simultaneous display of up to 16 channels, and provides independent cursors for each channel.

ScanCal

Also included with ChartView or TempView data-logging software is ScanCal, a Windows-based application that automates instrument calibration. ScanCal provides familiar pull-down and toolbar menus for easy calibration within the Windows 3.X or Windows 95/NT environment.

Introduction	11
The Package.....	11
Front Panel Indicators.....	12
Rear Panel Switches & Connectors.....	13
TempScan/1100 & MultiScan/1200 Specifications.....	14
Hardware Configuration	17
IEEE 488 Configuration.....	18
RS-232/RS-422 Configuration.....	18
Calibration Protection Configuration.....	23
Digital I/O Configuration.....	23
TTL Output & Trigger Input Configuration.....	24
Expanded Memory Configuration.....	25
Scanning Card & Channel Expansion.....	26

Introduction

The Package

All TempScan/1100 and MultiScan/1200 components are carefully inspected prior to shipment. When you receive your temperature-and-voltage measurement system, carefully unpack all items from the shipping carton and check for any damage which may have occurred during shipment. Promptly report the damage to the shipping agent and your sales representative. Retain all shipping materials in case you must return the unit to the factory.

Every TempScan/1100 or MultiScan/1200 package includes the following items listed by part number:

- **TempScan/1100 or MultiScan/1200:** High-Speed Temperature & Voltage Instruments
- **296-0601:** Programmed Disks in IBM format, including the ChartView and TempView Software
- **Temp/Multi-901:** TempScan / MultiScan User's Manual
- **PR-10:** License Agreement
- **PR-2:** Warranty Card
- **199-0800:** Accessories Kit, which includes the following:
 - **CN-18-50:** DB50 Digital I/O Mating Connector
 - **CA-1:** Power Cable
 - **FE-1:** Rubber Feet (4)
 - **EN-6:** Rack Ears (2)
 - **HA-41-6:** Rack Screws (4)
 - **PR-9:** Rack Mounting Instructions
 - **FU-1-.5:** 1/2A Replacement Fuse
 - **FU-1-.25:** 1/4A Replacement Fuse

Front Panel Indicators

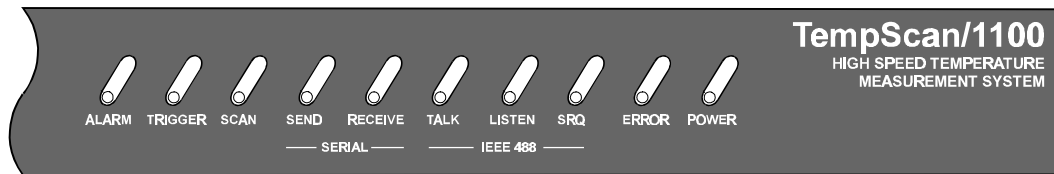

TempScan/1100 Front Panel

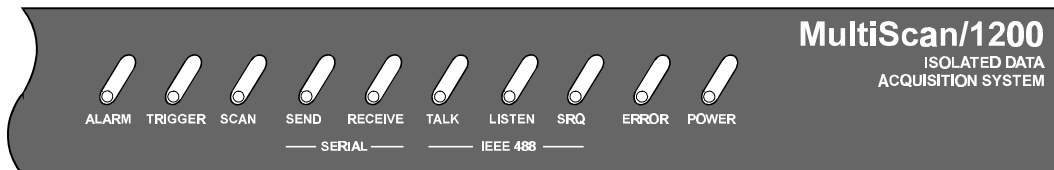

MultiScan/1200 Front Panel

Ten (10) LED indicators on the front panel of either the TempScan/1100 or MultiScan/1200 display the status of the temperature-and-voltage measurement system:

- **ALARM:** ON when an alarm has occurred. The indicator remains ON until the alarm condition clears. OFF when no alarm condition exists.
- **TRIGGER:** Flashes when **Armed** and waiting for a *Trigger*; is ON continuously when triggered; is OFF when data collection is finished. The *Trigger* is also turned OFF by IEEE **DCL** or **SDC**.
- **SCAN:** ON when the unit is storing a channel scan in its internal buffer.
- **SEND:** (For RS-232/RS-422 operation only) ON when transmitting data to the serial interface.
- **RECEIVE:** (For RS-232/RS-422 operation only) ON when receiving data from the controlling computer.
- **TALK:** (For IEEE 488 operation only) ON when the unit is in the Talker state, OFF when the unit is in the Idle or Listener state.
- **LISTEN:** (For IEEE 488 operation only) ON when the unit is in the Listener state, OFF when the unit is in the Idle or Talker state.
- **SRQ:** (For IEEE 488 operation only) ON when the unit has generated a Service Request (SRQ), OFF when no SRQ is pending. For more information, see command *Set SRQ Mask (M)*.
- **ERROR:** ON when an error has occurred, OFF when no error condition exists. For more information, see command *Query Error Status (E?)*.
- **POWER:** ON when power is applied to the unit and the power switch on the back panel is in the ON position (depressed). OFF if power is not present.

Rear Panel Switches & Connectors

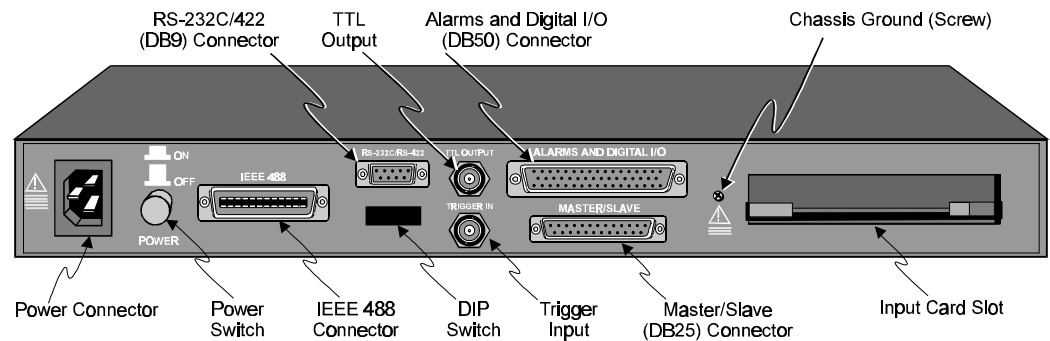

TempScan/1100 or MultiScan/1200 Rear Panel

Two (2) switches, seven (7) connectors, one (1) grounding nut, and one (1) input card slot on the rear panel of either the TempScan/1100 or MultiScan/1200 provide power, IEEE 488 addressing, triggering, a single point grounding node, and I/O connections.

- **Power Switch:** Used to turn power to the unit ON and OFF. When the switch is in the depressed position the power is ON. When in the extended position, the power is OFF.
- **DIP Switch:** For IEEE 488: Used for selecting IEEE 488 communication and bus address. For RS-232/RS-422: Used for selecting RS-232/RS-422 serial communication, handshaking, parity and baud rate. Microswitch 9 is used to enable/disable the hardware protected portion of NV-RAM.
- **Power Connector:** Provides power for the unit. Internally configurable for either 105-125 or 210-250 VAC, 50/60Hz, plus fuse circuit breaker.
- **IEEE 488 Connector:** Port for the IEEE 488 interface.
- **RS-232C/RS-422 Connector:** DB9 serial port for operation at remote distances from controlling computer supports 300 to 9,600 baud using RTS/CTS or XON/XOFF handshaking (XON/XOFF for ASCII transmissions only).
- **TTL Output Connector:** BNC TTL scan output signal occurs for each channel scan; used for synchronizing other equipment with TempScan/1100 or MultiScan/1200 acquisition.
- **Trigger Input Connector:** BNC trigger input for starting and/or stopping acquisition of the TTL output signal.
- **Alarms & Digital I/O Connector:** DB50 port offers easy access to Alarms and Digital I/O (32 digital outputs and 8 digital inputs)
- **Master/Slave Connector:** DB25 master/slave port connects to Exp/10A and/or Exp/11A expansion slave units to support applications of up to 992 channels with the TempScan/1100 master unit, or up to 744 channels with the MultiScan/1200 master unit.
- **Grounding Screw:** An external single-point grounding node has been supplied for (but not limited to) thermocouple shield termination.

TempScan/1100 & MultiScan/1200 Specifications

CAUTION



Please read this manual carefully! If equipment is used in any manner not specified in this manual, the protection provided by the equipment may be impaired.

Note: These specifications are subject to change without notice.

Channels

Number of Slots: One (1) slot

Number of Channels (TempScan/1100): Up to 32 differential thermocouple or voltage inputs, or up to 16 RTD inputs; accepts TempTC/32B, TempV/32B, or TempRTD/16B scanning modules

Number of Channels (MultiScan/1200): Up to 24 differential thermocouple or voltage inputs; accepts MTC/24 or MHV/24 scanning modules.

Channel Attributes: High and low set points; hysteresis values for high and low set points.

Scan Sequence: Any combination of temperature and voltage channels may be scanned, but channels are scanned in ascending numerical order.

Scan Interval: Absolute time between scans (**hh:mm:ss.s**); min = 00:00:00.0, max = 99:59:59.9.

Note that specifying a value of 00:00:00.0 results in no delay between channel scans.

Scanning Modes (TempScan/1100): *For thermocouples up to 500 feet:* 960 channels/sec @ 60 Hz; 800 channels/sec @ 50 Hz; *For thermocouples over 500 feet:* 240 channels/sec @ 60 Hz, 200 channels/sec @ 50 Hz.

Scanning Modes (MultiScan/1200): *For multi-channel scanning:* 147 channels/sec @ 50 or 60 Hz; *For 32-point line-cycle averaging enabled:* 44 channels/sec @ 60 Hz, 38.5 channels/sec @ 50 Hz; *For single-channel burst mode:* 1 channel @ 20K samples/sec.

Triggers

Installation Category: *For CE:* Category 1.

Programmable Triggering: Temperature or Voltage level (above or below), absolute time of day, alarm condition (on or off), IEEE GET, IEEE TALK, external TTL trigger (rising or falling), specified number of readings.

Temperature-Level Trigger: Programmable value for any one channel. *For MultiScan/1200:* This trigger not available when in single-channel burst mode.

TTL Trigger: Programmable for rising or falling edges.

Pre-Trigger Count: Programmable integer (< memory size -1).

Post-Trigger Count: Programmable integer.

Trigger Input Connector: External BNC connector

Trigger Output Connector: External BNC connector

Data Storage & Format

Storage: 128 K reading (256 Kbyte) standard; optional 500 K reading (1 Mbyte), 2 M reading (4 Mbyte), 4 M reading (8 Mbyte).

Data Formats: ASCII and binary; binary format returns a 16-bit compensated and linearized temperature value (0.1°C/bit); user-programmable for hi/low byte or low/hi byte. Note that high speed DMA transfers are binary format only.

Statistical Parameters: High, Low, and Last available per channel. *For MultiScan/1200:* Not available when in single-channel burst mode.

Time Stamping: Available for each scan group and for each channel's high, low, and last parameters. *For MultiScan/1200:* Not available when in single-channel burst mode.

Time Format: Absolute Time/Date stamping (**hh:mm:ss.mil,MM/DD/YY**), relative Time/Date stamping (**+hh:mm:ss.mil,DDDDDD**) and scan interval timebase (**hh:mm:ss.t**). *For MultiScan/1200:* Not available when in single-channel burst mode.

Alarm Stamp: Available for each scan group. *For MultiScan/1200:* Not available when in single-channel burst mode.

Digital Input Stamp: Available for each scan group. *For MultiScan/1200:* Not available when in single-channel burst mode.

IEEE 488 Interface

CAUTION



The IEEE 488 terminal must only be used to control a non-isolated IEEE 488 system. The common mode voltage (cable shell to earth) must be zero.

Interface Use: Digital communication (as opposed to analog) for IEEE 488 compliant computer platforms, as well as IEEE 488 compliant *platform-independent* configurations. Messages sent 1 byte (8 bits) at a time. Supports data rates up to 1 Mbyte/sec. Up to 15 devices can be connected to one bus. Total bus length up to 20 meters. Allowable cable distance between devices is up to 2 meters. Message transactions are hardware handshaked.

Installation Category: *For CE:* Category 1.

Implementation: SH1, AH1, T6, TE4, L4, LE4, SR1, PP0, RL0, DC1, DT1, C0, E1.

Programmable Parameters: Alarm set points, thermocouple type, temperature units, Trigger level, Pre-Trigger and Post-Trigger scan interval, Trigger mode, SRQ mask, scan count, Pre-Trigger count, digital input, digital output, real time settings, data output format, and terminators.

Data Transfer Speed: Up to >300 Kbytes/s.

Connector: Standard IEEE 488 connector with metric studs.

RS-232/RS-422 Serial Interface

CAUTION



The RS-232/RS-422 terminal is only for connecting devices having signals at serial communications levels.

Installation Category: *For CE:* Category 1.

Baud Rates: 300, 600, 1200, 2400, 4800 and 9600.

Data Bits: 8.

Stop Bits: 1.

Parity: Even, Odd, None.

Handshaking: RTS/CTS, XON/XOFF (for ASCII transmissions only).

Connector: Male DB-9.

Digital I/O Interface & Alarms

Installation Category: *For CE:* Category 1.

Number of Digital Inputs: 8 bits, TTL level compatible.

Number of Digital Outputs: 32 bits, TTL level compatible. Can be programmed as alarms. Note that the 32 TTL outputs can be set or cleared via program control.

Alarm Conditions: May be detected by SRQ or by software query (**SPo11** or **U** command).

Alarm Update Rate: Alarms are updated whenever a channel assigned to an alarm is measured.

Connector: Female DB50 50-pin (32 Alarms, 8 digital inputs, 10 ground pins), mating connector supplied.

General

Installation Category: *For CE:* Category 2 for Line Voltage Input terminal. All other terminals are Category 1.

Warm Up: 1 hour to rated accuracy.

Master/Slave Port: Female DB-25.

Chassis Ground Connection: Screw terminal.

Dimensions: 425 mm wide \times 305 mm deep \times 45 mm high (16.75" \times 12" \times 1.75").

Weight: 3.62 kg. (8 lbs.).

Operating Environment: *For standard:* Indoor use, 0 to 50°C; 0 to 95% RH (non-condensing) to 35°C; linearly derate 3% RH/°C from 35 to 50°C; *For CE: Indoor use at altitudes below 2000 m, 0 to 40°C; 0 to 80% RH up to 31°C decreasing linearly 4% RH/°C to 40°C.*

Control Switches: Power Switch, IEEE 488 or RS-232/RS-422, IEEE address, handshake, parity, baud rate, calibration memory write enable/disable.

Front Panel Indicators: LED indicators for ALARM, TRIGGER and SCAN; for SEND and RECEIVE (serial interface); for TALK, LISTEN and SRQ (for IEEE 488 interface); and for ERROR and POWER.

Power: 105-125 or 210-250 VAC, 50/60 Hz; 20 VA maximum (internal slide switch).

CAUTION



Line Voltage: The protective conductor terminal on the AC line connector must be connected to an external protective earthing system. Failure to make such a connection will impair protection from shock.

WARNING



Service: This product contains no operator serviceable parts. Service must be performed by qualified personnel. All terminals, including the AC line and scanning cards, must be disconnected prior to opening the TempScan/1100 or MultiScan/1200 case. Internal voltage potentials exist which could cause bodily injury or death!

Fuse: 1/2A, 250 V, Slo Blo, 3AG (for 105-125V power line) or 1/4A, 250V, Slo Blo, 3AG (for 210-250V power line).

CAUTION



Fuse Failure: Fuse failure indicates a possible problem within the device circuitry. If a fuse blows, contact a qualified service representative. Replacement fuses are to be installed by qualified service personnel with the unit disconnected from the power source and with all other terminals disconnected. If the line voltage selector is changed, then the fuse designated for that line voltage must be used.

Calibration

Calibration of cold junction sensor: Software control of calibrated thermocouple using the `ScanCal` program. (Calibration performed for each card and chassis in the system).

Voltage Calibration: Software control of gain and offset.

Calibration Constants: Chassis constants stored in NV-RAM. Card constants stored in card's on-board EEPROM.

Hardware Configuration

The TempScan/1100 or MultiScan/1200 unit is equipped with a high-speed IEEE 488 interface and an RS-232/RS-422 interface. Its IEEE 488 interface is useful in laboratory applications and enables real-time transfers of acquired data to the host computer's hard drive for inexpensive mass storage. Its RS-232/RS-422 interface is ideal in applications that require the placement of instrumentation at remote distances from the controlling computer, such as process and environmental control.

This unit can be set up with an IEEE 488 or a RS-232/RS-422 interface configuration, as determined by the DIP switch accessible from the rear panel. This DIP switch via its nine microswitches select which command set is to be used – IEEE 488 or RS-232/RS-422 – and the operating parameters for each. The table shows the options for its nine microswitches. Additional DIP switch settings are shown in the following sections.

Rear Panel DIP Switch				
Micro-switch #	Label	Setting	Description	
			IEEE 488	RS-232/RS-422
1	COMM SELECT	0	IEEE 488	(N/A)
		1	(N/A)	RS-232/RS-422
2,3	HANDSHAKE (H/S)	00	No Handshake	No Handshake
		01	Software Handshake only (XON/XOFF) (See Note)	Software Handshake only (XON/XOFF) (See Note)
		10	Hardware Handshake only (RTS/CTS)	Hardware Handshake only (RTS/CTS)
		11	Both Hardware and Software Handshake	Both Hardware and Software Handshake
4,5	IEEE ADDRESS or PARITY	00	Decimal value 0	No Parity
		01	Decimal value 8	Odd Parity
		10	Decimal value 16	Even Parity
		11	Decimal value 24	(N/A)
6,7,8	IEEE ADDRESS or BAUD RATE	000	Decimal value 0	300 baud
		001	Decimal value 1	600 baud
		010	Decimal value 2	1200 baud
		011	Decimal value 3	2400 baud
		100	Decimal value 4	4800 baud
		101	Decimal value 5	9600 baud (See Note)
		110	Decimal value 6	(N/A)
		111	Decimal value 7	(N/A)
9	CHASSIS CALIBRATION ENABLE	0	Disabled	Disabled
		1	Enabled	Enabled

Note: (1) XON/XOFF handshaking is valid for ASCII transmissions only. (2) At 9600 baud, hardware (RTS/CTS) handshaking and possibly software (XON/XOFF) handshaking may be required to maintain serial performance. However, for RS-422 operation with a Macintosh, RTS/CTS handshaking is not recommended.

The rear panel DIP switch is read only during power-on or reset and should be set before applying power. To modify any of these defaults, change the microswitch settings using a small screwdriver. The enclosure does not need to be opened to change these settings.

IEEE 488 Configuration

One way in which the TempScan/1100 or MultiScan/1200 unit can be controlled, is through its IEEE 488 port connector. Consequently, when configured as an IEEE 488 bus device, the unit must have an IEEE 488 bus address.

DIP Switch

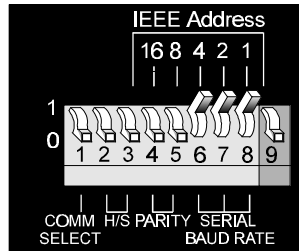

DIP Switch Settings for IEEE 488 Operation (Default)

For IEEE 488 operation, the single microswitch labeled *COMM SELECT* should be down (0) on the rear panel DIP switch. This down (0) position is the factory default. The up (1) position is reserved for RS-232/RS-422 serial communication. When IEEE 488 operation is enabled, the five microswitches labeled *IEEE ADDRESS* are used to configure the required IEEE 488 bus address.

The bus address can be set from 0 through 30 and is read only at power-on or reset. The address is selected by simple binary weighting. The switch labeled 1 is the least significant bit (LSB); 16 is the most significant bit (MSB). The factory default is bus address 7. Note that if address 31 is selected, it defaults to address 30 because the IEEE 488 standard has reserved address 31.

The rear panel DIP switch is read only during power-on or reset and should be set before applying power. To modify any of these defaults, change the microswitch settings using a small screwdriver. The enclosure does not need to be opened to change these settings.

RS-232/RS-422 Serial Configuration

Alternatively, the TempScan/1100 or MultiScan/1200 unit can be controlled through its serial port connector. Complete serial port configuration is accomplished by using both internal jumpers and DIP switch settings. The internal jumpers, located on the main board behind each serial connector, are used to configure the port with either RS-232 or RS-422 electrical characteristics. The DIP switch, located on the rear panel, is used to determine handshaking, parity, and baud rate. Furthermore, the selection of an RS-232 or RS-422 electrical configuration determines the serial port pattern of pin connector signals, as discussed later.

Internal Jumpers

The jumpers within the unit configure the serial port electrically as either RS-232 or RS-422. To change the serial port configuration, it is necessary to perform the following steps:

WARNING



Never disassemble the case while it is connected to the AC power line! Internal voltage potentials exist which could cause bodily injury or death!

WARNING



Never disconnect the AC power line from the TempScan/1100 or MultiScan/1200 while its scanning cards are connected to an external device! Common mode voltage potentials exceeding 60 VDC or 30 Vrms at the terminals, may exist which could cause bodily injury or death!

Note: If disassembly or disconnections are necessary, first turn off the power, then disconnect the scanning cards, next disconnect the AC power line, and then any other cables, prior to unit disassembly.

To Change the Serial Configuration

1. Turn off the power, disconnect the scanning cards, the power line cord, then all other cables from the unit. For more information, see section *Disconnecting & Reconnecting the System During Setup* on page 6.
2. Place the unit on a flat surface. Remove the six screws on top of the case. Remove the top cover.
3. The serial port is capable of operating in RS-232 or RS-422 mode. This selection is done via a set of hardware jumpers located on the main board behind the serial connector. A 12-position jumper plug must be inserted in one of the two available positions for proper operation (across JP11 and JP12 for RS-232, across JP12 and JP13 for RS-422). These jumpers are factory set for RS-232 as shown in the figure. To reconfigure the serial port for RS-422 operation, remove the jumper plug and reinsert it into the lower 2 rows of jumpers.

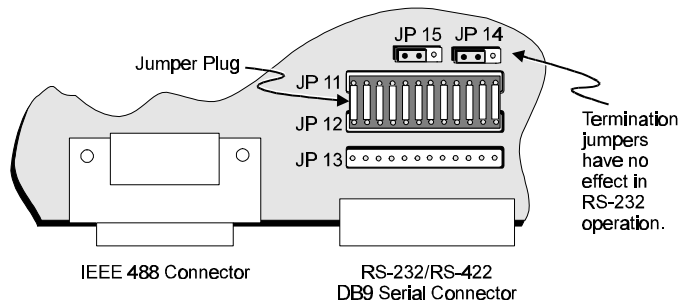

Internal Jumper Settings Configured for RS-232

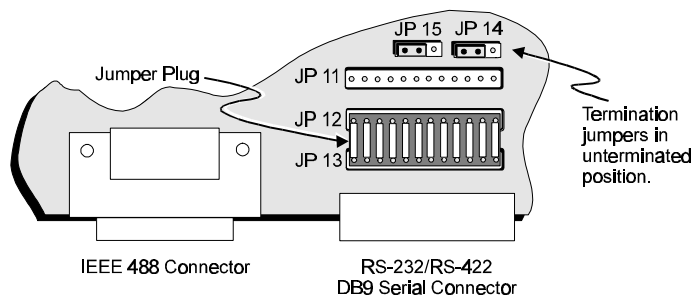

Internal Jumper Settings Configured for RS-422

4. If configured for RS-422, the port's Receive Data (RxD+) and Clear to Send (CTS+) input lines may optionally be terminated with a 100-Ohm resistor. Termination resistors are selected by positioning the two flea clips (labelled JP14 and JP15). These jumpers are factory set to the unterminated position, as indicated in the previous figures. Note that when using RS-422 in a single-ended configuration, ports must be unterminated. Termination jumpers have no effect when the port is configured for RS-232 operation.
5. Once the jumper(s) have been repositioned for your application, make note of the new jumper settings for later reference.
6. Carefully reassemble the unit.

Note: For re-assembly, first reconnect the AC power line (with the power OFF), next reconnect the scanning cards, and then any other cables, prior to reapplying power to the entire system.

DIP Switch

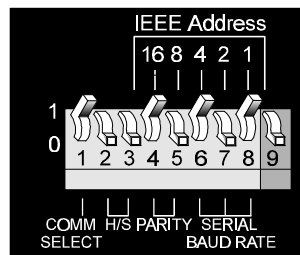

DIP Switch Settings for RS-232/RS-422 Serial Operation

To configure the TempScan/1100 or MultiScan/1200 for RS-232/RS-422 serial operation, the single microswitch labeled *COMM SELECT* must be up (1) on the rear panel DIP switch. The down (0) position is reserved for IEEE 488 communication. When serial operation is enabled, additional DIP microswitches configure the following required parameters: *Handshaking*, *parity*, and *baud rate*.

Handshaking. When the RS-232 port is used, the type of handshaking must be selected by the two microswitches labeled *H/S*. The options available are: No handshaking, XON/XOFF, RTS/CTS or both XON/XOFF and RTS/CTS handshaking. Note that XON/XOFF handshaking is valid for ASCII transmissions only, and for RS-422 operation with a Macintosh, RTS/CTS handshaking is not recommended.

Parity. The parity must be selected using the two microswitches labeled *PARITY*. The options provided are: No parity, odd parity or even parity.

Baud rate. The baud rate is selected using the three microswitches labeled *SERIAL BAUD RATE*. The available baud rates are 300, 600, 1200, 2400, 4800, and 9600.

Note: (1) XON/XOFF handshaking is valid for ASCII transmissions only. (2) At 9600 baud, hardware (RTS/CTS) handshaking and possibly software (XON/XOFF) handshaking may be required to maintain serial performance. However, for RS-422 operation with a Macintosh, RTS/CTS handshaking is not recommended.

The rear panel DIP switch is read only during power-on or reset and should be set before applying power. To modify any of these defaults, change the microswitch settings using a small screwdriver. The enclosure does not need to be opened to change these settings.

Serial Connector Pins

The TempScan/1100 or MultiScan/1200 unit is equipped with one DB-9S serial connector on its rear panel and requires a DB-9P mating connector. This connector is configured as an IBM PC when RS-232 levels are selected, and as a Macintosh when RS-422 levels are selected.

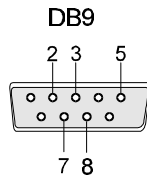

Computer-End Connector - DB9

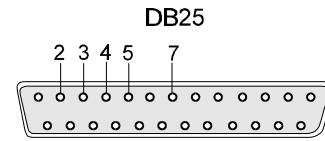

Computer-End Connector - DB25

A CA-47 cable connects the unit with the computer. The TempScan/1100 or MultiScan/1200 end has one DB9 connector, and the computer end has two connectors – one for a DB9 and one for a DB25. Other crossover-type cables can be used if they are wired as shown in the tables. The tables list the following four connections from the TempScan/1100 or MultiScan/1200 unit:

- To a DB9 connector configured for RS-232
- To a DB25 connector configured for RS-232
- To a DB9 connector configured for RS-422
- To a Mini DIN8 connector configured for RS-422.

TempScan/1100 or MultiScan/1200 To PC Connection (RS-232)				
DB9 Male Pin & Signal		Cable Wiring	DB9 Female Pin & Signal	
2	RxD-	←---	3	TxD-
3	TxD-	---→	2	RxD-
5	GND	←→	5	GND
7	RTS+	---→	8	CTS+
8	CTS+	←---	7	RTS+

TempScan/1100 or MultiScan/1200 To PC Connection (RS-232)				
DB9 Male Pin & Signal		Cable Wiring	DB25 Female Pin & Signal	
2	RxD-	←---	2	TxD-
3	TxD-	---→	3	RxD-
5	GND	←→	7	GND
7	RTS+	---→	5	CTS+
8	CTS+	←---	4	RTS+

TempScan/1100 or MultiScan/1200 To Macintosh Connection (RS-422)				
DB9 Male Pin & Signal		Cable Wiring	DB9 Male Pin & Signal	
1	GND	←→	3	GND
2	RTS+	---→	7	CTS+
4	TxD+	---→	8	RxD+
5	TxD-	---→	9	RxD-
6	CTS+	←---	6	RTS+
8	RxD+	←---	4	TxD+
9	RxD-	←---	5	TxD-

TempScan/1100 or MultiScan/1200 To Macintosh Connection (RS-422)				
DB9 Male Pin & Signal		Cable Wiring	Mini DIN8 Male Pin & Signal	
1	GND	←→	4	GND
2	RTS+	---→	2	CTS+
4	TxD+	---→	8	RxD+
5	TxD-	---→	5	RxD-
6	CTS+	←---	1	RTS+
8	RxD+	←---	6	TxD+
9	RxD-	←---	3	TxD-

The following text describes the various pin connector signals:

- **Transmit Data Negative (TxD-):** This output pin transmits serial data to an RS-232 or RS-422 device. The serial data received is sent with the word length, baud rate, stop bits, and parity configured for the particular port. This signal is low true.
- **Transmit Data Positive (TxD+):** This output pin transmits serial data to an RS-422 device only. The pin functions identically to TxD- except that its polarity is inverted. This signal is high true.
- **Receive Data Negative (RxD-):** This input pin accepts serial data sent by an RS-232 or RS-422 device. The serial data received is expected to match the word length, baud rate, stop bits, and parity configuration of the particular port. This signal is low true.
- **Receive Data Positive (RxD+):** This input pin accepts serial data sent by an RS-422 device only. It functions identically to RxD- except that its polarity is inverted. This signal is high true.
- **Request To Send Positive (RTS+):** This output pin is used as a hardware handshake line to prevent an RS-232 or RS-422 device from transmitting serial data to the TempScan/1100 or MultiScan/1200 unit when it is not able to accept it. When automatic RTS/CTS handshaking is selected, the unit will assert (high) the RTS+ signal when greater than 4096 memory locations are available in its internal buffers. If available memory drops below 4096 bytes, the unit unasserts (low) the RTS+ signal.
- **Request To Send Negative (RTS-):** This output pin is used as a hardware handshake line with an RS-422 device only. The pin functions identically to RTS+ except that its polarity is inverted. This signal is low true.
- **Clear To Send Positive (CTS+):** This input pin is used as a hardware handshake line to prevent the TempScan/1100 or MultiScan/1200 unit from transmitting serial data to an RS-232 or RS-422 device when it is not able to accept it. When RTS/CTS handshaking is selected, the unit will not Transmit Data (TxD+) out while the CTS+ signal is un-asserted (low). When XON/XOFF or no handshaking is selected, the CTS+ line is ignored.
- **Clear To Send Negative (CTS-):** This input pin is used as a hardware handshake line with an RS-422 device only. It functions identically to CTS+ except that its polarity is inverted. This signal is low true.
- **Ground (GND):** This signal sets the ground reference point for the other RS-232/RS-422 input and output signals.

Calibration Protection Configuration

The chassis calibration constants and the calibration password are stored by the TempScan/1100 or MultiScan/1200 in Non-Volatile RAM (NV-RAM). The password is a safety feature used to prevent unauthorized personnel from entering calibration mode and altering the calibration constants.

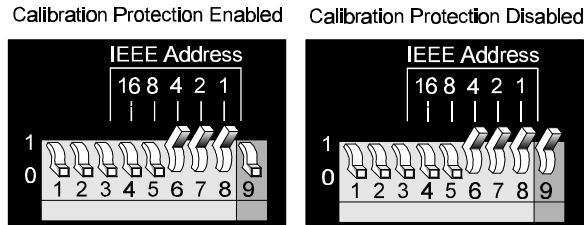

Calibration Protection Settings - Microswitch 9

As a safeguard, the calibration password and chassis calibration constants are hardware protected. This protection is enabled by setting the microswitch 9 to the down (0) position on the rear panel DIP switch. This is the default factory setting and should remain in this position unless purposely attempting to change the password or chassis constants.

If it is necessary to change the calibration password (via the *K command) or to recalibrate the chassis, this hardware write protection can be disabled by setting microswitch 9 to the up (1) position. For details on calibration, see chapter *System Calibration*.

CAUTION

Do not forget to set back the DIP microswitch 9 to the down (0) position when calibration is complete. Otherwise, the calibration password and calibration constants may be corrupted and normal operation may be disrupted.

Digital I/O Configuration

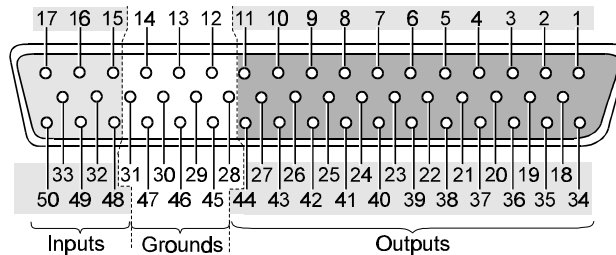

Digital I/O Port Connector - DB50

Located on the TempScan/1100 or MultiScan/1200 rear panel, the DB50 digital I/O connector provides eight (8) digital input lines and thirty-two (32) digital output lines. The figure and table locate and describe the input, output, and ground lines of this connector.

DB50 Digital I/O Pin Descriptions									
Line	Pin	Line	Pin	Line	Pin	Line	Pin	Line	Pin
Output 1	1	Output 11	37	Output 21	24	Output 31	11	Ground	12
Output 2	34	Output 12	21	Output 22	8	Output 32	44	Ground	13
Output 3	18	Output 13	5	Output 23	41	Input 1	15	Ground	14
Output 4	2	Output 14	38	Output 24	25	Input 2	48	Ground	28
Output 5	35	Output 15	22	Output 25	9	Input 3	32	Ground	29
Output 6	19	Output 16	6	Output 26	42	Input 4	16	Ground	30
Output 7	3	Output 17	39	Output 27	26	Input 5	49	Ground	31
Output 8	36	Output 18	23	Output 28	10	Input 6	33	Ground	45
Output 9	20	Output 19	7	Output 29	43	Input 7	17	Ground	46
Output 10	4	Output 20	40	Output 30	27	Input 8	50	Ground	47

Each digital output line will drive five (5) standard TTL (transistor-transistor logic) loads. All digital input lines are one-eighth (0.125) TTL loads. All inputs are protected against damage from high static voltage. Normal precautions should be taken to limit the input voltages to the range of 0.0 to 5.3 volts. All digital I/O lines are referenced to digital ground.

CAUTION	
	<p>Do not exceed the levels described. Otherwise, the TempScan/1100 or MultiScan/1200 unit may be damaged in a way that is not covered by the warranty.</p>

TTL Output & Trigger Input Configuration

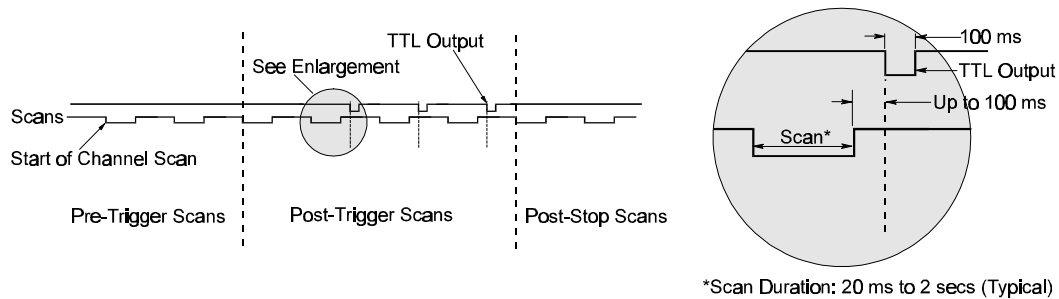

*Scan Duration: 20 ms to 2 secs (Typical)

Trigger Timing Diagram

The rear panel of the TempScan/1100 or MultiScan/1200 unit also provides two external BNC connectors: The TTL output and the trigger input. The BNC TTL scan output is used for synchronizing equipment with TempScan/1100 or MultiScan/1200 acquisition, while the BNC trigger input is used for starting and/or stopping acquisition of the TTL output. This trigger input can be programmed to activate on a rising (positive-going) or falling (negative-going) TTL level edge. Any TTL level signal ($> 2.2V = Hi$, $< 0.8V = Lo$) may be used as a trigger pulse. A trigger pulse may also be used to generate a Service Request. Note that the TTL Out is a LS-TTL compatible output, 0.4 mA sourcing, 8 mA sinking. When a scan is logged into the acquisition buffer(after the actual scan), the TTL output signal is pulsed for 100 ms. Refer to the timing diagram.

Expanded Memory Configuration

Either the TempScan/1100 or MultiScan/1200 can accommodate up to 8 MBytes of memory, which is ideal for both high-speed and long-term data logging. Measurements can be stored in memory and read out by a controlling computer as time permits. Readings may be transferred at up to 300 KBytes per second over the IEEE 488 bus, or up to 9600 baud using the unit's standard RS-232/RS-422 port.

Three memory options are provided for expanding the standard 256 KB memory: 1 MB (TempMEM1 or MultiMEM1), 4 MB (TempMEM4 or MultiMEM4), or 8 MB (TempMEM8 or MultiMEM8). To install a memory option into the unit, it is necessary to perform the following steps:

WARNING



Never disassemble the case while it is connected to the AC power line! Internal voltage potentials exist which could cause bodily injury or death!

WARNING



Never disconnect the AC power line from the TempScan/1100 or MultiScan/1200 while its scanning cards are connected to an external device! Common mode voltage potentials exceeding 60 VDC or 30 Vrms at the terminals, may exist which could cause bodily injury or death!

Note: If disassembly or disconnections are necessary, first turn off the power, then disconnect the scanning cards, next disconnect the AC power line, and then any other cables, prior to disassembly.

To Install a Memory Option

1. Turn off the power, disconnect the scanning cards, the power line cord, and then all other cables from the unit. For more information, see section *Disconnecting & Reconnecting the System During Setup* on page 6.
2. Place the unit on a flat surface. Remove the six screws on top of the case and remove the top cover.
3. Located on the main circuit-board assembly, alongside the scanning card enclosure, are SIMM memory module slots JP8 and JP7. Install your memory option according to the instructions in the following list:

For 1 MB (TempMEM1 or MultiMEM1): Remove the 256 KB module from JP7 and insert the 1 MB module in its place.

For 4 MB (TempMEM4 or MultiMEM4): Remove the 256 KB module from JP7 and insert the 4 MB module in its place.

For 8 MB (TempMEM8 or MultiMEM8): Remove the 256 KB module from JP7, insert one 4 MB module in its place, and insert the second 4 MB module in JP8.

4. Carefully reassemble the unit, replacing the top cover and screws.

Note: For re-assembly, first reconnect the AC power line (with the power OFF), next reconnect the scanning cards, and then any other cables, prior to reapplying power to the entire system.

Scanning Card & Channel Expansion

Scanning Card Expansion

Each TempScan/1100 or MultiScan/1200 unit can accept one scanning card to provide signal conditioning. However, if your application demands more channels then you can expand the master unit's capabilities with either or both types of expansion units: Exp/10A and/or Exp/11A. Each Exp/10A expansion unit allows for the addition of two scanning cards, while each Exp/11A expansion unit allows for the addition of ten scanning cards. Up to fifteen Exp/10A units can be attached to the master unit, giving a maximum of 30 additional scanning-card slots. Similarly, up to three Exp/11A units can be linked to the master unit, also giving a maximum of 30 additional scanning-card slots, as shown in the following table.

Expansion Capabilities	Exp/10A	Exp/11A
Number of expansion scanning-card slots per expansion unit	2	10
Number of identical expansion units that can be linked to the master unit	15	3
Maximum number of expansion scanning-card slots	30	30

Note: If a combination of Exp/10A and Exp/11A expansion units are linked together, then the maximum number of expansion scanning-card slots is still 30.

Channel Expansion

The TempScan/1100 system can be expanded up to 992 channels, while the MultiScan/1200 system can be expanded up to 744 channels. This is easily accomplished via a *master/slave architecture* wherein a main or *master* unit can be connected to as many expansion *slave* units as allowable within the maximum of 30 scanning cards.

Each Exp/10A or Exp/11A expansion unit has a form factor identical to that of either the TempScan/1100 or MultiScan/1200 master unit, allowing the expansion unit to accept the same scanning cards as its master unit. When connected to the TempScan/1100, the Exp/10A or Exp/11A is configurable for 32 or 64 input channels, providing a total expansion capacity of up to 992 channels. When connected to the MultiScan/1200, the Exp/10A or Exp/11A is configurable for 24 or 48 input channels, providing a total expansion capacity of up to 744 channels.

An expansion unit can only be controlled by the TempScan/1100 or MultiScan/1200 master unit, and no digital I/O or alarms are included. However, expansion channels can be programmed to stimulate the alarms located on the master unit. From the programmer's perspective, channels are accessed in the same way as channels in the master unit. When the master unit detects the presence of expansion units during its power-on sequence, it makes the additional channels available to the programmer. The **UB** command is available to query the master unit for the total number of channels in the system.

A general description of both types of expansion units, their connections and their configurations, is discussed in the following chapters.

Introduction 27
The Package.....27
Front Panel Indicators.....27
Rear Panel Switches & Connectors.....28
Exp/10A Specifications.....29

Hardware Configuration 30
Master/Slave Connection.....30
Slave Configuration.....31
Channel Assignment.....31

Introduction

The Package

All Exp/10A components are carefully inspected prior to shipment. When you receive your two-slot expansion chassis, carefully unpack all items from the shipping carton and check for any damage which may have occurred during shipment. Promptly report the damage to the shipping agent and your sales representative. Retain all shipping materials in case you must return the unit to the factory.

Every Exp/10A package includes the following items listed by part number:

- **Exp/10A:** Two-Slot Expansion Chassis
- **PR-2:** Warranty Card
- **227-0800:** Exp/10A Accessories Kit, which includes the following:
 - **CA-35-1:** DB25M-to-DB25M Master/Slave Cable
 - **CA-1:** Power Cable
 - **FE-1:** Rubber Feet (4)
 - **EN-6:** Rack Ears (2)
 - **HA-41-6:** Rack Screws (4)
 - **FU-1-.5:** 1/2A Replacement Fuse
 - **FU-1-.25:** 1/4A Replacement Fuse

Front Panel Indicators

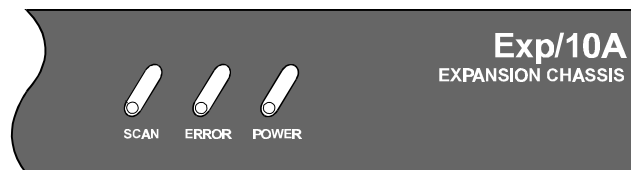

Exp/10A Front Panel

Three (3) LED indicators on the front panel of the Exp/10A display the status of the expansion unit:

- **SCAN:** ON when the master unit is storing a expansion channel scan in its internal buffer.
- **ERROR:** ON when an error has occurred, OFF when no error condition exists. For more information, see command *Query Error Status (E?)*.
- **POWER:** ON when power is applied to the unit and the power switch on the back panel is in the ON position (depressed). OFF if power is not present.

Rear Panel Switches & Connectors

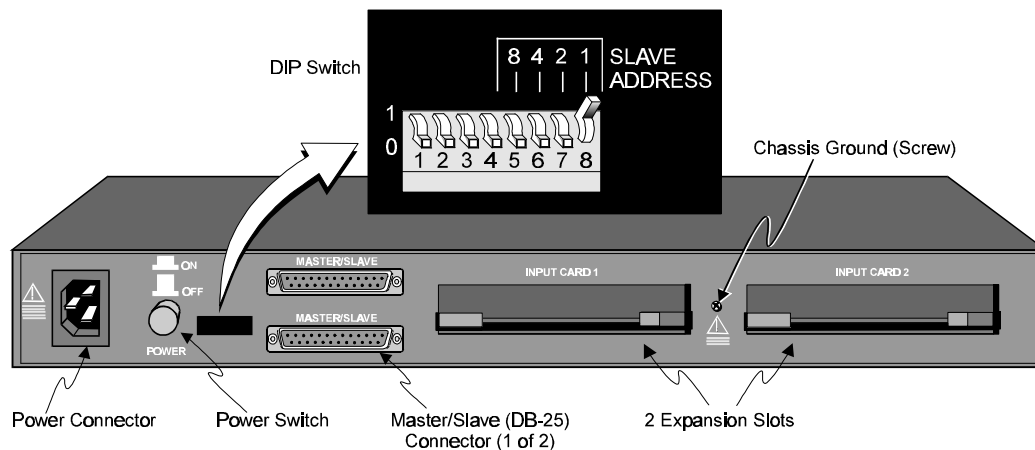

Exp/10A Rear Panel

Two (2) switches, three (3) connectors, one (1) grounding nut, and two (2) input card slots on the rear panel of the Exp/10A provide power, slave addressing, master/slave connections, a single point grounding node, and scanning card expansion.

- **Power Switch:** Used to turn power to the Exp/10A ON and OFF. When the switch is in the depressed position the power is ON. When in the extended position, the power is OFF.
- **DIP Switch:** Used for selecting the Exp/10A slave address ID.
- **Power Connector:** Provides power for the unit. Internally configurable for either 105-125 or 210-250 VAC, 50/60Hz, plus fuse circuit breaker.
- **Master/Slave Connector:** Two DB25 master/slave ports provide one connection to a TempScan/1100, MultiScan/1200, Exp/10A or Exp/11A unit, and one connection to another Exp/10A or Exp/11A expansion unit.
- **Grounding Screw:** An external single-point grounding node has been supplied for (but not limited to) thermocouple shield termination.
- **Shielded Enclosure:** *For the TempScan/1100:* Accepts any combination of TempTC/32B, TempV/32B, and/or TempRTD/16B scanning cards. *For the MultiScan/1200:* Accepts any combination of MTC/24 and/or MHV/24 scanning cards. Note that the TempScan/1100 and MultiScan/1200 scanning cards must not be mixed within the same system.

Exp/10A Specifications

CAUTION



Please read this manual carefully! If equipment is used in any manner not specified in this manual, the protection provided by the equipment may be impaired.

Note: These specifications are subject to change without notice.

Installation Category: *For CE:* Category 2 for Line Voltage Input terminal. All other terminals are Category 1.

Master/Slave Port: Female DB-25 (2)

Number of Slots: Two (2).

Number of Channels (TempScan/1100): Up to 64 differential voltage or thermocouple inputs, or up to 32 RTD inputs; accepts any combination of two (2) TempTC/32B, TempV/32B or TempRTD/16B scanning modules.

Number of Channels (MultiScan/1200): Up to 48 differential voltage or thermocouple inputs; accepts any combination of two (2) MTC/24 and MHV/24 scanning modules.

Channel to System Isolation: 60V peak.

Dimensions: 425mm wide x 305mm deep x 45mm high (16.75"

Weight: 2.53 kg. (5.5 lbs.).

Operating Environment: *For standard:* Indoor use, 0 to 50°C; 0 to 95% RH (non-condensing) to 35°C; linearly derate 3% RH/°C from 35 to 50°C; *For CE:* Indoor use at altitudes below 2000 m, 0 to 40°C; 0 to 80% RH up to 31°C decreasing linearly 4% RH/°C to 40°C.

Controls: Power Switch (external), DIP switch for setting slave ID (external).

Front Panel Indicators: LED indicators for SCAN, ERROR, and POWER.

Power: 105-125 or 210-250 VAC, 50/60 Hz; 20 VA maximum.

CAUTION



Line Voltage: The protective conductor terminal on the AC line connector must be connected to an external protective earthing system. Failure to make such a connection will impair protection from shock.

WARNING



Service: This product contains no operator serviceable parts. Service must be performed by qualified personnel. All terminals, including the AC line and scanning cards, must be disconnected prior to opening the Exp/10A case. Internal voltage potentials exist which could cause bodily injury or death!

Fuse: 1/2A, 250 V, Slo Blo, 3AG (for 105-125V power line) or 1/4A, 250V, Slo Blo, 3AG (for 210-250V power line).

CAUTION



Fuse Failure: Fuse failure indicates a possible problem within the device circuitry. If a fuse blows, contact a qualified service representative. Replacement fuses are to be installed by qualified service personnel with the unit disconnected from the power source and with all other terminals disconnected. If the line voltage selector is changed, then the fuse designated for that line voltage must be used.

Hardware Configuration

Master/Slave Connection

Up to fifteen Exp/10A expansion units can be connected to the TempScan/1100 or MultiScan/1200 master unit, giving options of up to 30 expansion scanning cards. Connect the expansion unit as described in the following steps:

CAUTION	
	Before connecting an Exp/10A expansion unit to its master unit, or to another expansion unit, power down all devices that are connected or to be connected. Failure to do so could damage the equipment.

To Connect the Exp/10A Expansion Unit

1. Turn power off and unplug the master unit and all devices connected to the system.
2. If not already done so, turn power off and unplug the Exp/10A unit(s) which are to be connected.
3. Connect the master/slave cable(s) (CA-35-1) as depicted in the following illustration.

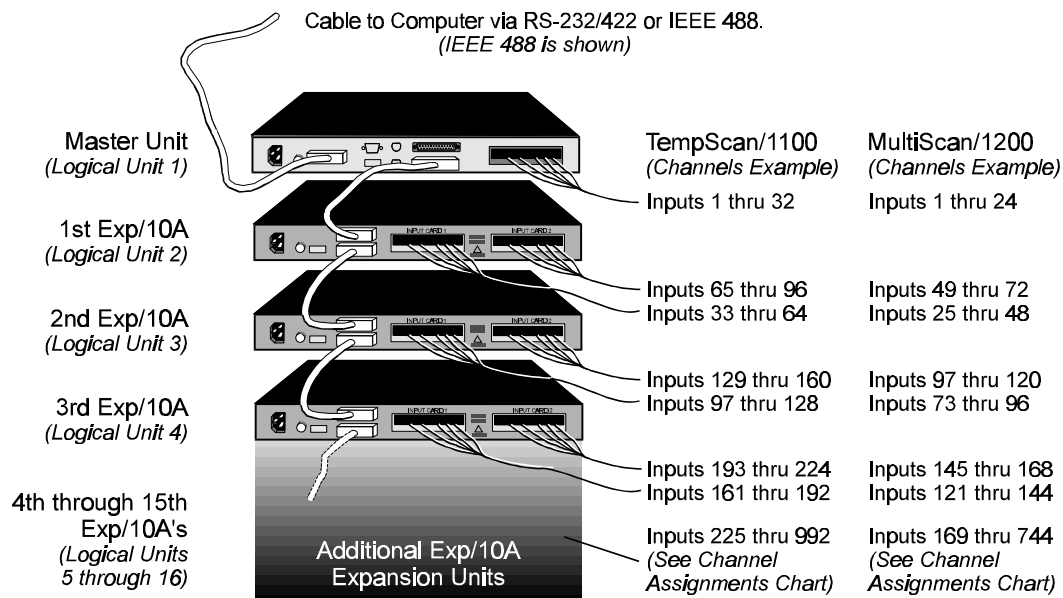

A total of 15 Exp/10A units can be linked in the "master/slave" fashion as illustrated. Note that the master unit must always be the first component in the link.

Connected Exp/10A Expansion Units

4. Plug in all system devices.
5. Set the slave address on the rear panel DIP switch. See next section *Slave Configuration*.
6. Turn power on to the master unit.
7. Turn power on to the remaining system devices.

Slave Configuration

CAUTION



Avoid linking two or more expansion chassis with the same slave address. Otherwise, the unspecified addresses may result in operating errors.

For the master/slave configuration to operate correctly, the master unit must either be a TempScan/1100 or MultiScan/1200; it cannot be an Exp/10A or Exp/11A expansion unit.

Furthermore, each Exp/10A unit must be assigned a unique slave address. Following simple binary weighting, this slave address is set by using microswitches 5 through 8 of the rear panel DIP switch. In the following figure, DIP microswitch 8 is in the up position, indicating the default slave address 1.

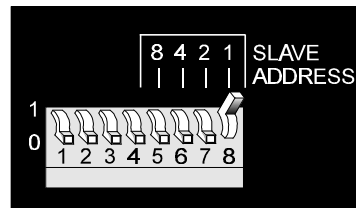

DIP Microswitches 5 to 8 - Slave Address Settings

With all four microswitches 5, 6, 7 and 8 in the up position, this setting indicates a slave address of 15 ($8 + 4 + 2 + 1$). A maximum of 15 Exp/10A slave addresses can be set, while the address of 0 is not allowed. The Exp/10A factory default is address 1.

Note: The address of 0 is not allowed because this is reserved for the master unit address.

Channel Assignment

Channels 1 through 32 are always in the TempScan/1100, and channels 1 through 24 are always in the MultiScan/1200, while the channels in the Exp/10A expansion unit are treated as extended channels. With the first Exp/10A slave unit, the first channel in the first scanning card is channel 33 in the TempScan/1100 system, and channel 25 in the MultiScan/1200 system. With the same slave unit, the first channel in the second scanning card is channel 65 in the TempScan/1100 system, and channel 49 in the MultiScan/1200 system. The order of multiple Exp/10A expansion units are set up using the rear panel DIP switches, as described earlier.

Even if a scanning card slot is left empty in the master unit and/or slave unit(s), the channel assignments remain the same, as shown in the table. For a 16-channel TempScan/1100 scanning card, the system still assigns 32 channels to the card slot with the second 16 channels ignored. Likewise, for a 12-channel MultiScan/1200 scanning card, the system still assigns 24 channels to the card slot with the second 12 channels ignored. For example, if a 16-channel TempRTD/16B scanning module is installed in the first slot of Logical Unit 2 (the first Exp/10A), then channels 33 through 48 will be assigned and channels 49 through 64 will be ignored.

Exp/10A Slave Address Settings		
Microswitches 5 through 8	Slave Address	Slave Unit
(0 0 0 0)	(0)	(Master Unit)
0 0 0 1	1	Slave 1
0 0 1 0	2	Slave 2
0 0 1 1	3	Slave 3
0 1 0 0	4	Slave 4
0 1 0 1	5	Slave 5
0 1 1 0	6	Slave 6
0 1 1 1	7	Slave 7
1 0 0 0	8	Slave 8
1 0 0 1	9	Slave 9
1 0 1 0	10	Slave 10
1 0 1 1	11	Slave 11
1 1 0 0	12	Slave 12
1 1 0 1	13	Slave 13
1 1 1 0	14	Slave 14
1 1 1 1	15	Slave 15

Exp/10A Channel Assignments			
Logical Unit	Card Slot	TempScan/1100 Master Unit	MultiScan/1200 Master Unit
(1)	(1)	(Inputs 1 – 32)	(Inputs 1 – 24)
2	1	Inputs 33 – 64	Inputs 25 – 48
	2	Inputs 65 – 96	Inputs 49 – 72
3	1	Inputs 97 – 128	Inputs 73 – 96
	2	Inputs 129 – 160	Inputs 97 – 120
4	1	Inputs 161 – 192	Inputs 121 – 144
	2	Inputs 193 – 224	Inputs 145 – 168
5	1	Inputs 225 – 256	Inputs 169 – 192
	2	Inputs 257 – 288	Inputs 193 – 216
6	1	Inputs 289 – 320	Inputs 217 – 240
	2	Inputs 321 – 352	Inputs 241 – 264
7	1	Inputs 353 – 384	Inputs 265 – 288
	2	Inputs 385 – 416	Inputs 289 – 312
8	1	Inputs 417 – 448	Inputs 313 – 336
	2	Inputs 449 – 480	Inputs 337 – 360
9	1	Inputs 481 – 512	Inputs 361 – 384
	2	Inputs 513 – 544	Inputs 385 – 408
10	1	Inputs 545 – 576	Inputs 409 – 432
	2	Inputs 577 – 608	Inputs 433 – 456
11	1	Inputs 609 – 640	Inputs 457 – 480
	2	Inputs 641 – 672	Inputs 481 – 504
12	1	Inputs 673 – 704	Inputs 505 – 528
	2	Inputs 705 – 736	Inputs 529 – 552
13	1	Inputs 737 – 768	Inputs 553 – 576
	2	Inputs 769 – 800	Inputs 577 – 600
14	1	Inputs 801 – 832	Inputs 601 – 624
	2	Inputs 833 – 864	Inputs 625 – 648
15	1	Inputs 865 – 896	Inputs 649 – 672
	2	Inputs 897 – 928	Inputs 673 – 696
16	1	Inputs 929 – 960	Inputs 697 – 720
	2	Inputs 961 – 992	Inputs 721 – 744

Introduction 33
The Package.....33
Front Panel Indicators.....33
Rear Panel Switches & Connectors.....34
Exp/11A Specifications.....35

Hardware Configuration 36
Master/Slave Connection.....36
Slave Configuration.....37
Channel Assignment.....37

Introduction

The Package

All Exp/11A components are carefully inspected prior to shipment. When you receive your two-slot expansion chassis, carefully unpack all items from the shipping carton and check for any damage which may have occurred during shipment. Promptly report the damage to the shipping agent and your sales representative. Retain all shipping materials in case you must return the unit to the factory.

Every Exp/11A package includes the following items listed by part number:

- **Exp/11A:** Ten-Slot Expansion Chassis
- **PR-2:** Warranty Card
- **CA-35-1:** DB25M-to-DB25M Master/Slave Cable
- **CA-1:** Power Cable
- **412-2015:** Rack Ears (2)
- **HA-41-6:** Rack Screws (4)

Front Panel Indicators

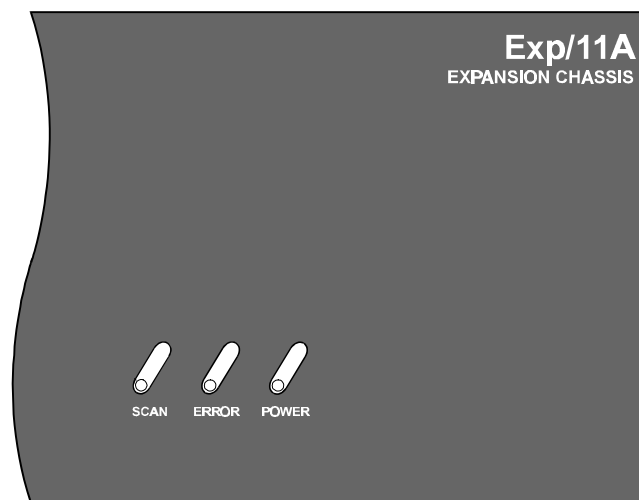

Exp/11A Front Panel

Three (3) LED indicators on the front panel of the Exp/11A display the status of the expansion unit:

- **SCAN:** ON when the master unit is storing a expansion channel scan in its internal buffer.
- **ERROR:** ON when an error has occurred, OFF when no error condition exists. For more information, see command *Query Error Status (E?)*.
- **POWER:** ON when power is applied to the unit and the power switch on the back panel is in the ON position (depressed). OFF if power is not present.

Rear Panel Switches & Connectors

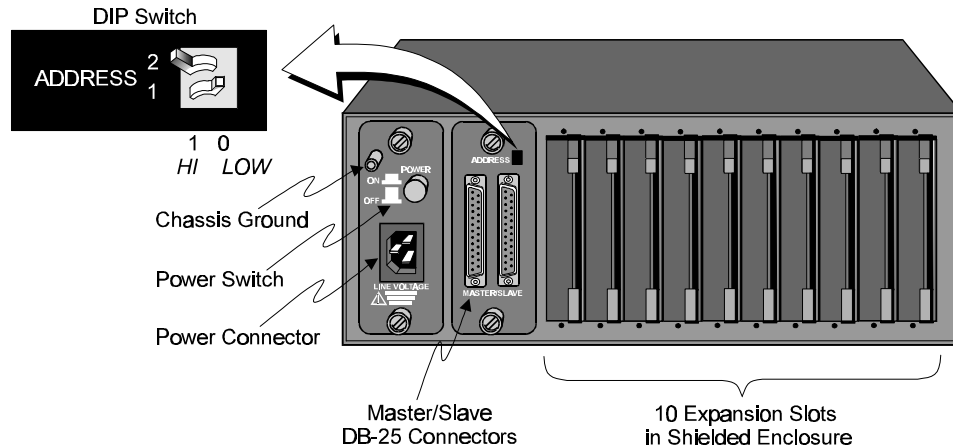

Exp/11A Rear Panel

Two (2) switches, three (3) connectors, one (1) grounding nut, and ten (10) input card slots on the rear panel of the Exp/11A provide power, slave addressing, master/slave connections, a single point grounding node, and scanning card expansion.

- **Power Switch:** Used to turn power to the Exp/11A ON and OFF. When the switch is in the depressed position the power is ON. When in the extended position, the power is OFF.
- **DIP Switch:** Used for selecting the Exp/11A slave address ID.
- **Power Connector:** Provides power for the unit. Internally configurable for either 105-125 or 210-250 VAC, 50/60Hz, plus fuse circuit breaker.
- **Master/Slave Connector:** Two DB25 master/slave ports provide one connection to a TempScan/1100, MultiScan/1200, Exp/10A or Exp/11A unit, and one connection to another Exp/10A or Exp/11A expansion unit.
- **Grounding Screw:** An external single-point grounding node has been supplied for (but not limited to) thermocouple shield termination.
- **Shielded Enclosure:** For the TempScan/1100: Accepts any combination of TempTC/32B, TempV/32B, and/or TempRTD/16B scanning cards. For the MultiScan/1200: Accepts any combination of MTC/24 and/or MHV/24 scanning cards. Note that the TempScan/1100 and MultiScan/1200 scanning cards must not be mixed within the same system.

Exp/11A Specifications

CAUTION



Please read this manual carefully! If equipment is used in any manner not specified in this manual, the protection provided by the equipment may be impaired.

Note: These specifications are subject to change without notice.

Installation Category: *For CE:* Category 2 for Line Voltage Input terminal. All other terminals are Category 1.

Master/Slave Port: Female DB25 (2).

Number of Slots: Ten (10).

Number of Channels (TempScan/1100): Up to 320 differential voltage or thermocouple inputs, or up to 160 RTD inputs; accepts any combination of ten (10) TempTC/32B, TempV/32B or TempRTD/16B scanning modules.

Number of Channels (MultiScan/1200): Up to 240 differential voltage or thermocouple inputs; accepts any combination of ten (10) MTC/24 and MHV/24 scanning modules.

Channel to System Isolation: 60V peak.

Dimensions: 425mm wide x 305mm deep x 135mm high (16.75"

Weight: 6.36 kg. (14 lbs.).

Operating Environment: *For standard:* Indoor use, 0 to 50°C; 0 to 95% RH (non-condensing) to 35°C; linearly derate 3% RH/°C from 35 to 50°C; *For CE:* Indoor use at altitudes below 2000 m, 0 to 40°C; 0 to 80% RH up to 31°C decreasing linearly 4% RH/°C to 40°C.

Controls: Power Switch (external), DIP switch for setting slave ID (external).

Front Panel Indicators: LED indicators for SCAN, ERROR, and POWER.

Power: 105-125 or 210-250 VAC, 50/60 Hz; 20 VA maximum

CAUTION



Line Voltage: The protective conductor terminal on the AC line connector must be connected to an external protective earthing system. Failure to make such a connection will impair protection from shock.

WARNING



Service: This product contains no operator serviceable parts. Service must be performed by qualified personnel. All terminals, including the AC line and scanning cards, must be disconnected prior to opening the Exp/11A case. Internal voltage potentials exist which could cause bodily injury or death!

Fuse: 1/2A, 250 V, Slo Blo, 3AG (for 105-125V power line) or 1/4A, 250V, Slo Blo, 3AG (for 210-250V power line).

CAUTION



Fuse Failure: Fuse failure indicates a possible problem within the device circuitry. If a fuse blows, contact a qualified service representative. Replacement fuses are to be installed by qualified service personnel with the unit disconnected from the power source and with all other terminals disconnected. If the line voltage selector is changed, then the fuse designated for that line voltage must be used.

Hardware Configuration

Master/Slave Connection

Up to three Exp/11A expansion units can be connected to the TempScan/1100 or MultiScan/1200 master unit, giving options of up to 30 expansion scanning cards. Connect the expansion unit as described in the following steps:

CAUTION	
	Before connecting an Exp/11A expansion unit to its master unit, or to another expansion unit, power down all devices that are connected or to be connected. Failure to do so could damage the equipment.

To Connect the Exp/11A Expansion Unit

1. Turn power off and unplug the master unit and all devices connected to the system.
2. If not already done so, turn power off and unplug the Exp/11A unit(s) which are to be connected.
3. Connect the master/slave cable(s) (CA-35-1) as depicted in the following illustration.

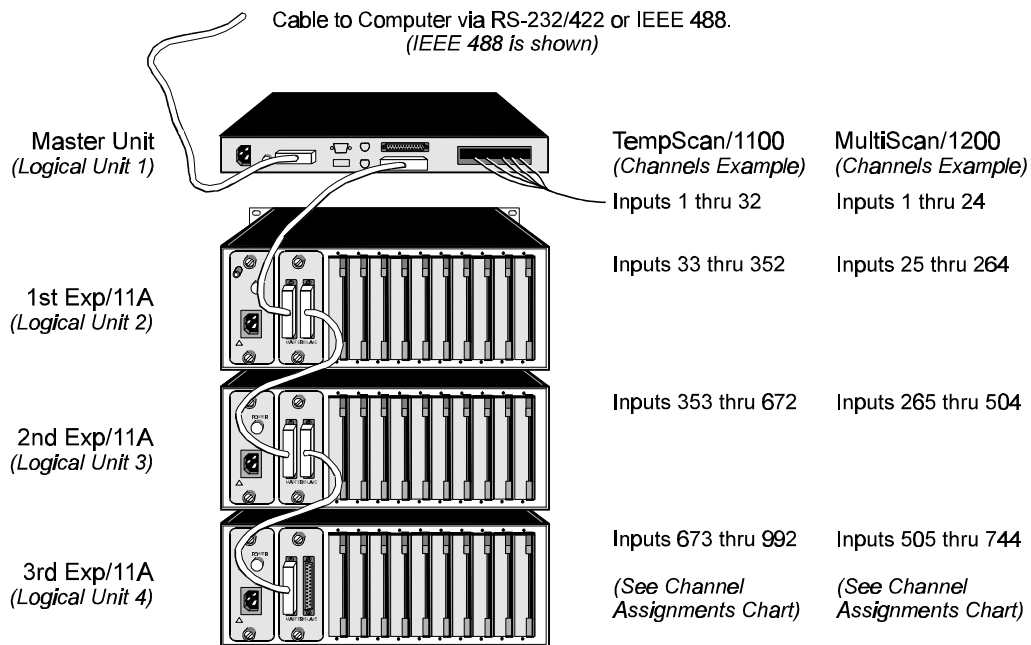

A total of 3 Exp/11A units can be linked in the "master/slave" fashion as illustrated. Note that the master unit must always be the first component in the link.

Connected Exp/11A Expansion Units

4. Plug in all system devices.
5. Set the slave address on the rear panel DIP switch. See next section *Slave Configuration*.
6. Turn power on to the master unit.
7. Turn power on to the remaining system devices.

Slave Configuration

CAUTION



Avoid linking two or more expansion chassis with the same slave address. Otherwise, the unspecified addresses may result in operating errors.

For the master/slave configuration to operate correctly, the master unit must either be a TempScan/1100 or MultiScan/1200; it cannot be an Exp/10A or Exp/11A expansion unit.



1 0
HI LOW

DIP Microswitches 1 & 2 - Slave Address Settings

Furthermore, each Exp/11A unit must be assigned a unique slave address. Following simple binary weighting, this slave address is set by using microswitches 1 and 2 of the rear panel DIP switch. In the previous figure, DIP microswitch 1 is in the LOW position while DIP microswitch 2 is in the HI position, indicating the slave address 1. A maximum of 3 Exp/11A slave addresses can be set – 0, 1, and 2 – while the address of 3 is not allowed. The Exp/11A factory default is address 0.

Note: The address of 3 is invalid. If this address is set, the LED indicator ERROR will light up.

Channel Assignment

Channels 1 through 32 are always in the TempScan/1100, and channels 1 through 24 are always in the MultiScan/1200, while the channels in the Exp/11A expansion unit are treated as extended channels. With the first Exp/11A slave unit, the first channel in the first scanning card is channel 33 in the TempScan/1100 system, and channel 25 in the MultiScan/1200 system. With the same slave unit, the first channel in the second scanning card is channel 65 in the TempScan/1100 system, and channel 49 in the MultiScan/1200 system. The order of multiple Exp/10A expansion units are set up using the rear panel DIP switches, as described earlier.

Even if a scanning card slot is left empty in the master unit and/or slave unit(s), the channel assignments remain the same, as shown in the table. For a 16-channel TempScan/1100 scanning card, the system still assigns 32 channels to the card slot with the second 16 channels ignored. Likewise, for a 12-channel MultiScan/1200 scanning card, the system still assigns 24 channels to the card slot with the second 12 channels ignored. For example, if a 16-channel TempRTD/16B scanning module is installed in the first slot of Logical Unit 2 (the first Exp/10A), then channels 33 through 48 will be assigned and channels 49 through 64 will be ignored.

Exp/11A Slave Address Settings		
Microswitches 1 and 2	Slave Address	Slave Unit
(N/A)	(N/A)	(Master Unit)
0 0	0	Slave 1
0 1	1	Slave 2
1 0	2	Slave 3
(1 1)	(3)	(Invalid)

Exp/11A Channel Assignments			
Logical Unit	Card Slot	TempScan/1100 Master Unit	MultiScan/1200 Master Unit
(1)	(1)	(Inputs 1 – 32)	(Inputs 1 – 24)
2	1	Inputs 33 – 64	Inputs 25 – 48
	2	Inputs 65 – 96	Inputs 49 – 72
	3	Inputs 97 – 128	Inputs 73 – 96
	4	Inputs 129 – 160	Inputs 97 – 120
	5	Inputs 161 – 192	Inputs 121 – 144
	6	Inputs 193 – 224	Inputs 145 – 168
	7	Inputs 225 – 256	Inputs 169 – 192
	8	Inputs 257 – 288	Inputs 193 – 216
	9	Inputs 289 – 320	Inputs 217 – 240
	10	Inputs 321 – 352	Inputs 241 – 264
3	1	Inputs 353 – 384	Inputs 265 – 288
	2	Inputs 385 – 416	Inputs 289 – 312
	3	Inputs 417 – 448	Inputs 313 – 336
	4	Inputs 449 – 480	Inputs 337 – 360
	5	Inputs 481 – 512	Inputs 361 – 384
	6	Inputs 513 – 544	Inputs 385 – 408
	7	Inputs 545 – 576	Inputs 409 – 432
	8	Inputs 577 – 608	Inputs 433 – 456
	9	Inputs 609 – 640	Inputs 457 – 480
	10	Inputs 641 – 672	Inputs 481 – 504
4	1	Inputs 673 – 704	Inputs 505 – 528
	2	Inputs 705 – 736	Inputs 529 – 552
	3	Inputs 737 – 768	Inputs 553 – 576
	4	Inputs 769 – 800	Inputs 577 – 600
	5	Inputs 801 – 832	Inputs 601 – 624
	6	Inputs 833 – 864	Inputs 625 – 648
	7	Inputs 865 – 896	Inputs 649 – 672
	8	Inputs 897 – 928	Inputs 673 – 696
	9	Inputs 929 – 960	Inputs 697 – 720
	10	Inputs 961 – 992	Inputs 721 – 744
(N/A)	(N/A)	(N/A)	(N/A)

Introduction	39
TempTC/32B Thermocouple Scanning Card	40
TempTC/32B Specifications.....	40
TempTC/32B Description.....	41
TempV/32B Voltage Scanning Card	42
TempV/32B Specifications.....	42
TempV/32B Description.....	43
TempRTD/16B RTD Scanning Card	44
TempRTD/16B Specifications.....	44
TempRTD/16B Description.....	44

Introduction

The TempScan/1100 master unit and any Exp/10A and Exp/11A expansion units connected to this master unit, can each accept the following three kinds of optional solid-state scanning cards:

- TempTC/32B Thermocouple Scanning Card which measures thermocouples
- TempV/32B Voltage Scanning Card which measures voltages
- TempRTD/16B RTD Scanning Card which measures RTDs (resistance temperature devices)

Note: Do not mix TempScan/1100 and MultiScan/1200 scanning cards within the same system. TempScan/1100 scanning cards are designed for and supported only by the TempScan/1100 master unit. Likewise, MultiScan/1200 scanning cards are designed for and supported only by the MultiScan/1200 master unit. Otherwise, operating errors or equipment damage may occur.

Each scanning card contains screw-terminal blocks for quick and easy input connections. Connections are made by inserting the wire into a screw-terminal socket.

Several tie-down holes are provided for tie-wrap strain reliefs to keep wires from all the channels organized and manageable before they exit the rear panel of the master or expansion unit.

To keep noise outside and to maintain a constant internal temperature, each scanning card fits into a shielded metal enclosure inside the master or expansion unit. The foam padding on the scanning card provides an air dam to minimize gradients.

TempTC/32B Thermocouple Scanning Card

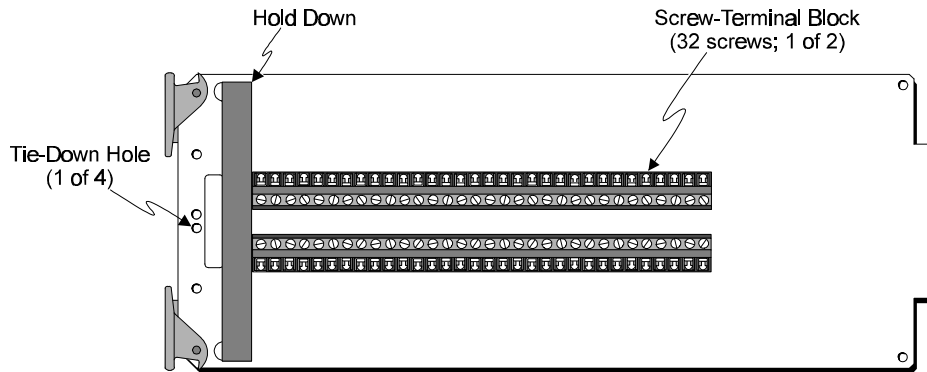

TempTC/32B Thermocouple Scanning Card

TempTC/32B Specifications

Note: These specifications are subject to change without notice.

Number of Channels: 32 differential; programmable by channel for specific thermocouple type or ± 100 mV full scale input.

Input Types: J, K, T, E, N, R, S, B, N14, N28, custom thermocouple, and millivolts.

Input Connector: Screw terminal.

Thermocouple Wire: #16 AWG maximum, #24 AWG minimum; #20 AWG recommended for type J, K, T, E and N; #24 AWG recommended for type R, S, and B.

Temperature Range, Accuracy, and Resolution: Accuracy is based on 18 to 28°C, 1 year; includes cold junction compensation; excludes thermocouple errors; thermocouple readings based on NIST Monograph 175. Resolution given is the typical value.

Thermocouple	Range	Accuracy	Resolution
Type J:	-200° to +760°C;	$\pm 0.5^\circ\text{C}$;	0.10°C.
Type K:	-100° to +1372°C;	$\pm 0.5^\circ\text{C}$;	0.10°C.
Type T:	-100° to +400°C;	$\pm 0.5^\circ\text{C}$;	0.10°C.
Type E:	-100° to +1000°C;	$\pm 0.5^\circ\text{C}$;	0.10°C.
Type N:	-200° to +1300°C;	$\pm 0.5^\circ\text{C}$;	0.10°C.
Type R:	0.0° to +1768°C;	$\pm 0.10^\circ\text{C}$;	0.20°C.
Type S:	0.0° to +1768°C;	$\pm 0.10^\circ\text{C}$;	0.20°C.
Type B:	+350° to +1820°C;	$\pm 0.10^\circ\text{C}$;	0.20°C.
Type N14:	0.0° to +1300°C;	$\pm 0.5^\circ\text{C}$;	0.10°C.
Type N28:	-270° to +400°C;	$\pm 0.5^\circ\text{C}$;	0.10°C.

Temperature Units: °C, °F, °K, °R, and mV.

Fault Detection: Open thermocouple may be detected by a software query.

Cold Junction Sensors: One for every 8 input channels.

Linearization: Performed by lookup table (varies by T/C type); table supports two user-defined custom T/C types of up to 256 points each. Lookup tables are stored in battery backed-up NV-RAM.

Input Impedance: 1 MOhm typical

Input Bias Current: 20 nA maximum.

Maximum Allowable Input: $\pm 35V$ peak.

Channel to Digital Low Isolation: *For standard:* 500V maximum; *For CE:* 200V maximum.

Channel to Channel Isolation: $\pm 10V$ peak.

Temperature Coefficient: 0.03 °C/°C.

Digital Filtering: Averages 16 samples @ 50/60 Hz for line cycle noise rejection.

Voltage Range, Accuracy and Resolution: 100 mV; $\pm 0.02\%$; and 3.05 μV .

Voltage Units: Volts, counts.

TempTC/32B Description

The TempTC/32B thermocouple scanning card contains 32 differential input channels, each of which may be configured as any thermocouple type or as a millivolt input. Temperature values may be returned in units of **C**, **F**, **K**, **R**, or **mV**.

There is a 4700-picofarad polypropylene capacitor connected across the input terminals of each channel. This capacitor acts to filter some of the input noise when measuring thermocouples. When the circuit card is set to the ± 100 millivolt range, this capacitor will react with the user source impedance to form a low-pass filter. The filter pole frequency will be $1/(2*\pi*(RSHI + RSLO)*4700 * 10^{-12})$, where RSHI and RSLO are the source resistance of the input leads.

When making differential voltage measurements with the TempTC/32B card, you should insure that one of the common terminal blocks is connected to the common of the unit being measured.

TempV/32B Voltage Scanning Card

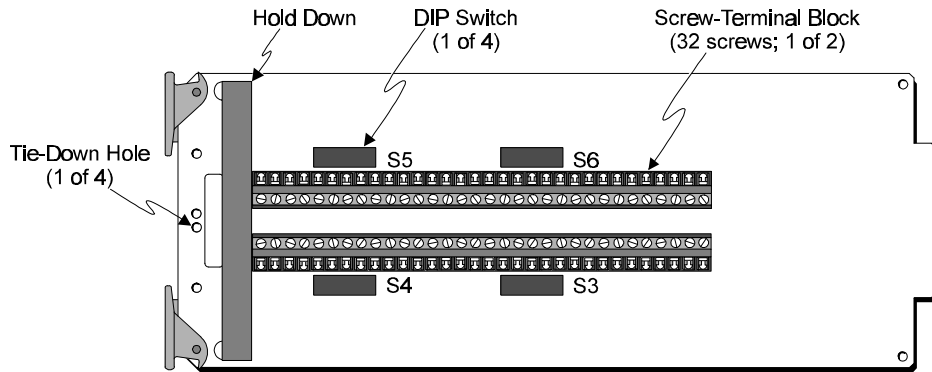

TempV/32A Voltage Scanning Card

All 8 Microswitches ON

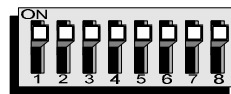

TempV/32A DIP Switch - Factory Default Settings
(For all four DIP Switches)

TempV/32B Specifications

Note: These specifications are subject to change without notice.

Number of Inputs: 32 differential.

Input Connectors: Screw Terminal.

Voltage Range, Accuracy and Resolution:

Range	Accuracy	Resolution
± 100 mV;	± 0.02%;	3.12 µV/bit
± 1 V;	± 0.02%;	31.2 µV/bit
± 5 V;	± 0.02%;	156 µV/bit
± 10 V;	± 0.02%;	312 µV/bit

Digital Filtering: Averages 16 samples @ 50/60 Hz for line cycle noise rejection.

Temperature Coefficient: < 0.01%/°C.

Input Impedance: 1 MOhm typical.

Input Bias Current: 40 nA maximum.

Common Mode Rejection: 100 dB typical.

Maximum Allowable Input: ± 35V peak.

Channel to Digital Low Isolation: For standard: 500V maximum; For CE: (Channel Common to Earth) 200V maximum.

Channel to Channel Isolation: ± 10V peak.

TempV/32B Description

The TempV/32B voltage scanning module contains 32 differential input channels and is capable of measuring analog input signals on any of four programmable ranges: ± 100 millivolt, \pm volt, ± 5 volt and ± 10 volt.

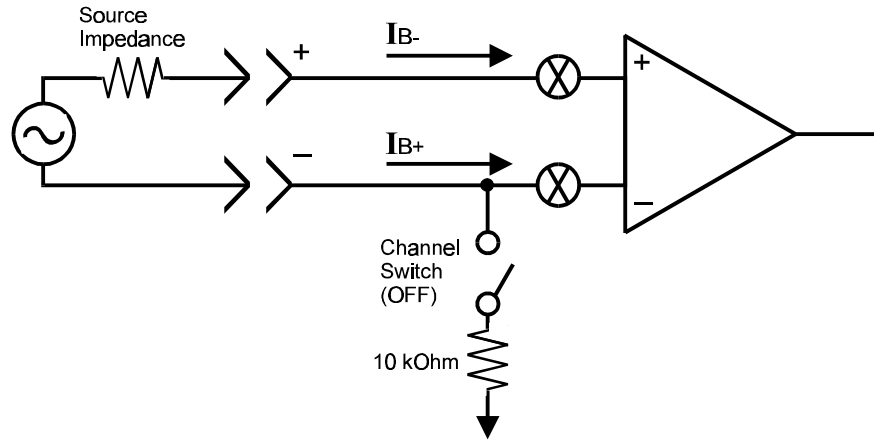

*TempV/32A - Input Bias Currents Diagram
(Channel Switch is OFF)*

For differential input configuration, each input must have biasing currents. A certain amount of current must be flowing into the differential inputs or else capacitance-induced noise will make the inputs appear as noise.

The low side of each differential input channel is provided with a switchable 10-k Ω resistor to analog common. This allows a current path when no current is flowing due to no common ground connections or a high-impedance input source. With no common ground connection, closing the switch connects a 10-k Ω resistor between the (L) input and ground and provides a common mode impedance.

The relationships between the DIP microswitches and specific channels are described in the table.

TempV/32B Channel-to-Microswitch Relationships							
Channel	Microswitch	Channel	Microswitch	Channel	Microswitch	Channel	Microswitch
1	S6-8	9	S3-8	17	S5-8	25	S4-8
2	S6-7	10	S3-7	18	S5-7	26	S4-7
3	S6-6	11	S3-6	19	S5-6	27	S4-6
4	S6-5	12	S3-5	20	S5-5	28	S4-5
5	S6-4	13	S3-4	21	S5-4	29	S4-4
6	S6-3	14	S3-3	22	S5-3	30	S4-3
7	S6-2	15	S3-2	23	S5-2	31	S4-2
8	S6-1	16	S3-1	24	S5-1	32	S4-1

TempRTD/16B RTD Scanning Card

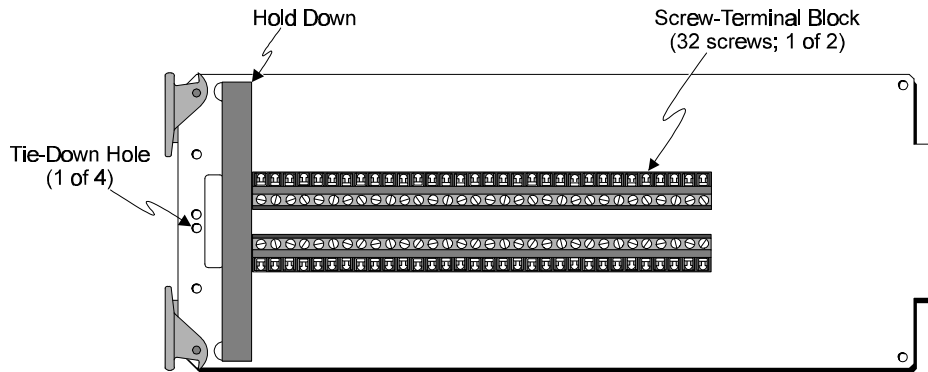

TempRTD/16A RTD Scanning Card

TempRTD/16B Specifications

Note: These specifications are subject to change without notice.

Number of Inputs: 16 (3 or 4 wire).

Alpha: 0.00385.

Input Connectors: Screw Terminal.

Temperature Range, Accuracy and Resolution:

RTD	Range	Accuracy	Resolution
Type 100 W Platinum:	-100° to +630°C;	± 0.2°C;	0.1°C
Type 100 W Platinum:	-270° to -100°C;	± 0.4°C;	0.2°C

Excitation Current: < 1 mA peak.

Temperature Coefficient: < 0.1%/°C

Temperature Units: °C, °F, °K, °R, and counts.

Linearization: Performed by lookup table; support included for storing user-defined linearization tables in NV-RAM.

TempRTD/16B Description

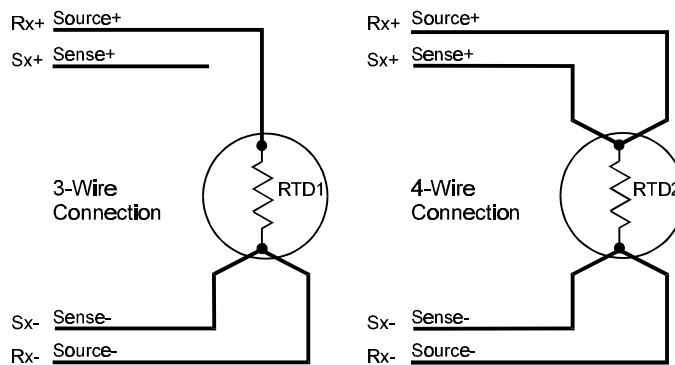

TempRTD/16A - RTD Connection Diagrams

The TempRTD/16B RTD scanning card supports 16 channels of 3-wire or 4-wire RTDs. Measurements may be returned in units of C, F, K, R. For proper hook-up, refer to the connection diagram.

Introduction	45
MTC/24 Thermocouple/Volt Scanning Card	46
MTC/24 Specifications.....	46
MTC/24 Description.....	47
MHV/24 High-Voltage Scanning Card	48
MHV/24 Specifications.....	48
MHV/24 Description.....	48

Introduction

The MultiScan/1200 master unit and any Exp/10A and Exp/11A expansion units connected to this master unit, can each accept the following two kinds of optional scanning cards:

- MTC/24 Thermocouple/Volt Scanning Module
- MHV/24 High-Voltage Scanning Module

Note: Do not mix TempScan/1100 and MultiScan/1200 scanning cards within the same system. TempScan/1100 scanning cards are designed for and supported only by the TempScan/1100 master unit. Likewise, MultiScan/1200 scanning cards are designed for and supported only by the MultiScan/1200 master unit. Otherwise, operating errors or equipment damage may occur.

Each scanning card contains screw-terminal blocks for quick and easy input connections. Connections are made by inserting the wire into a screw-terminal socket.

Several tie-down holes are provided for tie-wrap strain reliefs to keep wires from all the channels organized and manageable before they exit the rear panel of the master or expansion unit.

To keep noise outside and to maintain a constant internal temperature, each scanning card fits into a shielded metal enclosure inside the master or expansion unit. The foam padding on the scanning card provides an air dam to minimize gradients.

MTC/24 Thermocouple/Volt Scanning Card

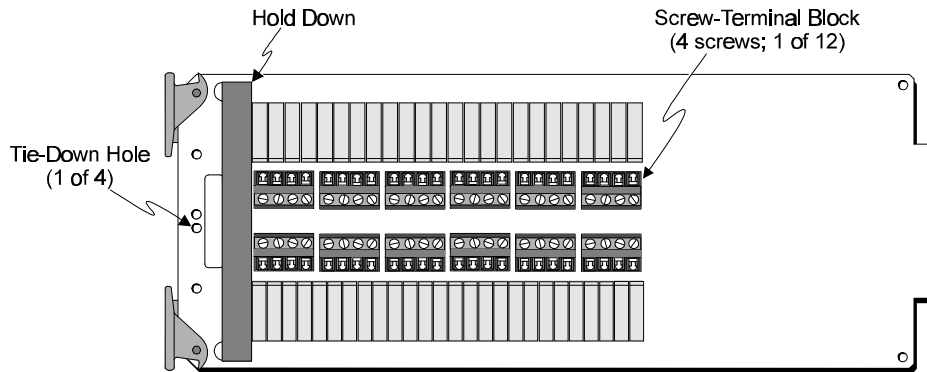

MTC/24 Thermocouple/Volt Scanning Card

MTC/24 Specifications

Note: These specifications are subject to change without notice.

Number of Channels: 24 differential; programmable by channel as specific thermocouple type or a voltage input.

Input Types: J, K, T, E, R, S, B, N custom thermocouple, and voltage.

Input Connectors: Screw Terminal

Thermocouple Wire: #16 AWG maximum, #24 AWG minimum; #20 AWG recommended for type J, K, T, E and N; #24 AWG recommended for type R, S, and B.

Temperature Range, Accuracy, and Resolution: Accuracy is based on 18 to 28°C, 1 year; includes cold junction compensation; excludes thermocouple errors; thermocouple readings based on NIST Monograph 175. Resolution given is the typical value; excludes thermocouple errors.

Thermocouple	Range	Accuracy	Resolution
Type J:	-100° to +760°C;	± 0.5°C;	0.10°C.
Type J:	-200° to -100°C;	± 0.8°C;	0.20°C.
Type K:	-100° to +1372°C;	± 0.6°C;	0.10°C.
Type K:	-200° to -100°C;	± 0.8°C;	0.20°C.
Type T:	-100° to +400°C;	± 0.5°C;	0.15°C.
Type T:	-200° to -100°C;	± 0.8°C;	0.25°C.
Type E:	-100° to +1000°C;	± 0.7°C;	0.10°C.
Type E:	-200° to -100°C;	± 0.9°C;	0.20°C.
Type R:	0.0° to +1780°C;	± 2.0°C;	0.40°C.
Type S:	0.0° to +1780°C;	± 2.0°C;	0.40°C.
Type B:	+350° to +1820°C;	± 2.0°C;	0.50°C.
Type N:	-100° to +1300°C;	± 0.6°C;	0.15°C.
Type N:	-200° to -100°C;	± 0.9°C;	0.20°C.

Temperature Units: °C, °F, °K, °R, and mV.

Fault Detection: Open thermocouple may be detected by a software query.

Cold Junction Sensors: One for every 8 input channels.

Linearization: Performed by lookup table (varies by T/C type); table supports two user-defined custom T/C types of up to 256 points each. Lookup tables are stored in battery backed-up NV-RAM.

Input Impedance: 1 MOhm

Input Bias Current: 20 nA max

Maximum Allowable Input: $\pm 25V$ rms

Maximum Common Mode Voltage: 200 VDC or AC peak. Specified for coupling impedance > 30 MOhm, and common mode frequency < 60 Hz. Maximum 300 VDC or AC peak before equipment damage occurs.

Maximum Normal Mode Voltage: 10 VDC or AC peak

Channel to Power Ground Isolation: 200 V peak

Channel to Channel Isolation: 200 V peak

Temperature Coefficient: $< (0.1 \times \text{rated accuracy})\%/^{\circ}C$.

Digital Filtering: Averages 32 samples @ 50/60 Hz for line-cycle noise rejection (DCV and thermocouple measurements)

Voltage Range, Accuracy and Resolution: Range is based on maximum peak-to-peak signal for AC volts. Accuracy is based on AC voltages where the frequency of the input signal is an integer multiple of the AC line cycle $\pm 1.0\%$, and with line-cycle integration enabled.

<i>Range</i>	<i>Accuracy</i>	<i>Resolution</i>
± 100 mV;	$\pm 0.02\%$ of range;	3.12 μV /bit
± 1 V;	$\pm 0.02\%$ of range;	31.2 μV /bit
± 5 V;	$\pm 0.02\%$ of range;	156 μV /bit
± 10 V;	$\pm 0.02\%$ of range;	312 μV /bit

MTC/24 Description

The MTC/24 thermocouple/volt scanning card contains 24 isolated differential input channels. Each channel can be programmed to receive inputs from thermocouple types J, K, T, E, R, S, B, and N, or from any of the following voltage ranges: ± 100 millivolts, \pm volt, ± 5 volts and ± 10 volts. Regarding thermocouples, temperature values can be returned in any of the following units: $^{\circ}C$, $^{\circ}F$, K , R , or mV.

MHV/24 High-Voltage Scanning Card

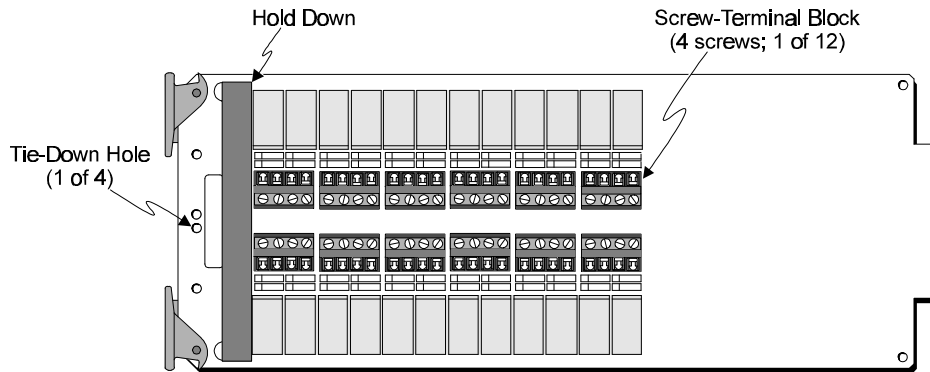

MHV/24 High-Voltage Scanning Card

MHV/24 Specifications

Note: These specifications are subject to change without notice.

Number of Inputs: 24 differential; programmable by channel for any input range

Input Connectors: Screw Terminal.

Voltage Range, Accuracy and Resolution: Range is based on maximum peak-to-peak signal for AC volts. Accuracy is based on AC voltages where the frequency of the input signal is an integer multiple of the AC line cycle $\pm 1.0\%$, and with line-cycle integration enabled.

Range	Accuracy	Resolution
± 2.5 V;	$\pm 0.02\%$ of range;	78.14 μ V/bit
± 25 V;	$\pm 0.02\%$ of range;	781.4 μ V/bit
± 250 V;	$\pm 0.02\%$ of range;	7.81 mV/bit

Digital Filtering: Averages 32 samples @ 50/60 Hz for line cycle noise rejection (DCV measurements).

Temperature Coefficient: $< 0.01\%/^{\circ}\text{C}$.

Input Impedance: 10 MOhm typical.

Input Bias Current: 20 pA maximum.

Maximum Common Mode Voltage: 500 VDC or AC peak. Specified for coupling impedance > 30 MOhm, and common mode frequency < 60 Hz. Maximum 700 VDC or AC peak before equipment damage occurs. Maximum 325 VDC or AC peak if used in the same system with the MTC/24 scanning module.

Maximum Normal Mode Voltage: 500 VDC or AC peak.

Common Mode Rejection: 100 dB typical.

Maximum Allowable Input: 400 VDC.

Channel to Power Ground Isolation: 500 V peak.

Channel to Channel Isolation: 500 V peak. Maximum 325 VDC or AC peak if used in the same system with the MTC/24 scanning module.

MHV/24 Description

The MHV/24 high-voltage scanning card contains 24 differential input channels and can measure analog input signals on any one of the following three programmable voltage ranges: ± 2.5 V, ± 25 V, and

Power Line & Fuse Configuration	49
Introduction.....	49
Line Voltage Selection.....	50
Fuse Replacement.....	52
Rack-Mount & Bench-Top Assembly	53
Rack Mount.....	53
Bench Top.....	53
Power-Up Activation	54

Power Line & Fuse Configuration

Introduction

The power configuration of any master or expansion unit consists of selecting the line voltage and replacing the fuses. All of these units – TempScan/1100, MultiScan/1200, Exp/10A, and Exp/11A – each has a factory default to operate at 105-125 volts AC. However, each unit may be operated at either 105-125 or 210-250 VAC.

WARNING



Do not use this unit outdoors! The unit is intended for indoor use only! Outdoor conditions could result in equipment failure, bodily injury or death!

WARNING



Never disassemble the case while it is connected to the AC power line! Internal voltage potentials exist which could cause bodily injury or death!

WARNING



Never disconnect the AC power line from the unit while its scanning cards are connected to an external device! Common mode voltage potentials exceeding 60 VDC or 30 Vrms at the terminals, may exist which could cause bodily injury or death!

To change the operating voltage of the TempScan/1100, MultiScan/1200, Exp/10A, and/or Exp/11A unit, it is necessary to open the enclosure. However, before modifying the voltage, disconnect any input or output connections from the rear panel of the affected unit and then disconnect the power cord from the power line terminal.

Line voltage must be set for 105-125 or 210-250 VAC to match the power being supplied to the TempScan/1100, MultiScan/1200, Exp/10A, and/or Exp/11A unit. If the line voltage is changed, the fuse must also be changed. Refer to the following text for the line voltage switch and fuse locations.

Line Voltage Selection

As already mentioned, the TempScan/1100, MultiScan/1200, Exp/10A and Exp/11A unit can each operate with 105-125 or 210-250 VAC, 50-60 Hz power, as set by its internal line-voltage switch (labelled S2 or SW2). Each unit is shipped from the factory with this operating voltage setting marked on its rear panel. If this is not the appropriate power setting to be supplied to the unit, then the line voltage and power fuse must be changed to avoid damage to the unit. The locations of switch S2 or SW2 and the fuse are shown in the figures. The line-voltage selection procedure is outlined in the following steps.

WARNING



Do not perform the procedures for line voltage selection and fuse replacement, unless qualified to do so! These procedures are intended to be used by qualified service personnel only!

WARNING



Never disassemble the unit casing while it is connected to the AC power line! Internal voltage potentials exist which could cause bodily injury or death!

WARNING



Never disconnect the AC power line from the unit while its scanning cards are connected to an external device! Common mode voltage potentials exceeding 60 VDC or 30 Vrms at the terminals, may exist which could cause bodily injury or death!

Note: If disassembly or disconnections are necessary, first turn off the power, then disconnect the scanning cards, next disconnect the AC power line, and then any other cables, prior to disassembly.

To Change the Line-Voltage Selection

1. Turn off the power, disconnect the scanning cards, the power line cord, and then all other cables from the unit. For more information, see section *Disconnecting & Reconnecting the System During Setup* on page 6.
2. Place the unit on a flat surface. *For the TempScan/1100, MultiScan/1200, and/or Exp/10A:* Remove the six screws on top of the case and remove the top cover. *For the Exp/11A:* Loosen the two thumb screws – one at each end – of the power module (left-most panel) and slide out the power module.
3. Located next to the main power supply transformer is the line voltage selection switch (labelled S2 or SW2). Using a small screwdriver, insert the tip of the screwdriver into the slot of the switch and slide the switch to the left or right *until it "clicks" into place* with the desired line voltage selection visible.

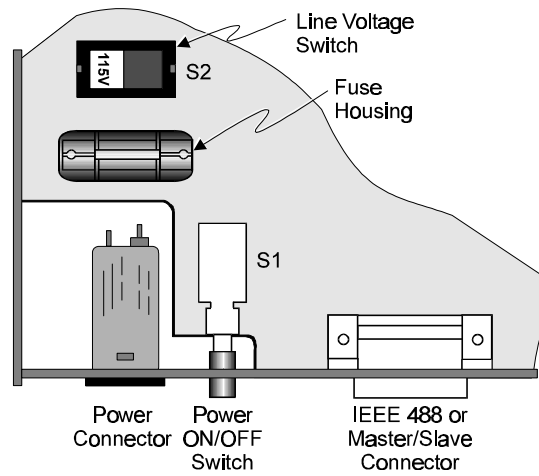

Top View of TempScan/1100, MultiScan/1200, or Exp/10A Circuit Board

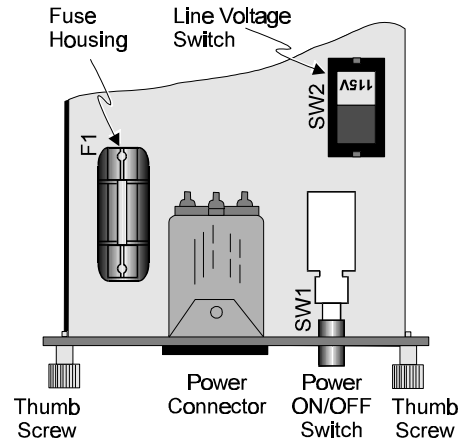

Top View of Exp/11A Power Module

CAUTION



It is possible to place the line voltage switch (S2 or SW2) in a partial position which could cause equipment damage or malfunction. When changing the position of the line voltage selection switch (S2 or SW2), make sure the switch is completely positioned to the 115 V or 220 V selection. The switch will click into place when properly positioned.

4. Install a power line fuse appropriate for the line voltage. See section *Fuse Replacement Step 3*, following this section.

CAUTION



Do not use a fuse with a rating higher than specified. Otherwise the unit may be damaged. If the instrument repeatedly blows fuses, locate and correct the cause of the trouble before replacing the fuse.

5. Make note of the new voltage setting for later reference.
6. Carefully reassemble the unit.

Note: For re-assembly, first reconnect the AC power line (with the power OFF), next reconnect the scanning cards, and then any other cables, prior to reapplying power to the entire system.

Fuse Replacement

The TempScan/1100, MultiScan/1200, Exp/10A and Exp/11A each contains an internal AC line fuse. This fuse is located next to the internal line-voltage switch (labelled S2 or SW2). You may replace the fuse by using the procedures found in the following text.

WARNING



Never disassemble the unit casing while it is connected to the AC power line! Internal voltage potentials exist which could cause bodily injury or death!

WARNING



Never disconnect the AC power line from the unit while its scanning cards are connected to an external device! Common mode voltage potentials exceeding 60 VDC or 30 Vrms at the terminals, may exist which could cause bodily injury or death!

Note: If disassembly or disconnections are necessary, first turn off the power, then disconnect the scanning cards, next disconnect the AC power line, and then any other cables, prior to disassembly.

To Replace the Fuse

1. Turn off the power, disconnect the scanning cards, the power line cord, and then all other cables from the unit. For more information, see section *Disconnecting & Reconnecting the System During Setup* on page 6.
2. Place the unit on a flat surface. *For the TempScan/1100, MultiScan/1200, and/or Exp/10A:* Remove the six screws on top of the case and remove the top cover. *For the Exp/11A:* Loosen the two thumb screws – one at each end – of the power module (leftmost panel) and slide out the power module.
3. Located next to the line-voltage selection switch (labelled S2 or SW2) is the power fuse. Gently pull upward on the plastic fuse housing. The entire housing with the fuse inside should be removed.
4. Open the fuse housing by pushing up on the tab on the bottom of the housing. Remove the fuse, and replace it with the proper type using the following list as a guide:
 - For line voltage 105-125 V, use fuse type 1/2 A 250 V, Slo Blo, 3AG
 - For line voltage 210-250 V, use fuse type 1/4 A 250 V, Slo Blo, 3AG

CAUTION



Do not use a fuse with a rating higher than specified. Otherwise the unit may be damaged. If the instrument repeatedly blows fuses, locate and correct the cause of the trouble before replacing the fuse.

5. Close the housing. Insert the fuse into the fuse holder.
6. Make note of the new fuse rating for later reference. If you have also changed the operating line-voltage selection, return to the previous section *Line Voltage Selection Step 5*.
7. Carefully reassemble the unit.

Note: For re-assembly, first reconnect the AC power line (with the power OFF), next reconnect the scanning cards, and then any other cables, prior to reapplying power to the entire system.

Rack-Mount & Bench-Top Assembly

The TempScan/1100, MultiScan/1200, Exp/10A and Exp/11A package each includes accessories for rack-mount or bench-top assembly.

Rack Mount

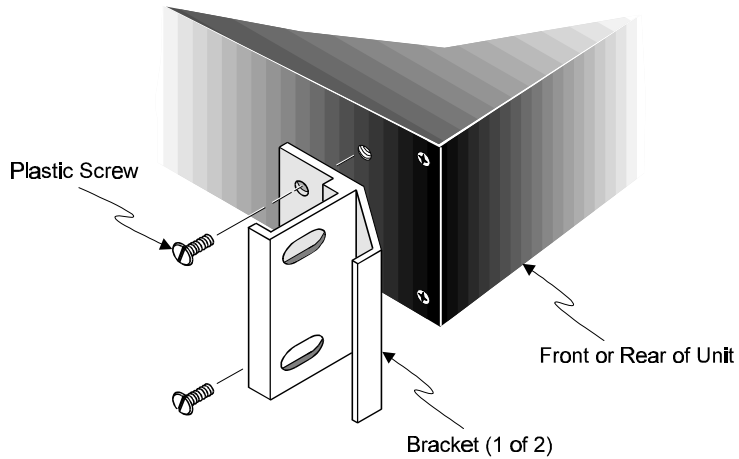

Attaching a Rack-Mount Bracket

If rack-mount assembly is required, remove the two plastic screws from the pre-drilled holes on each side of the unit. Since the unit can be mounted with the front or rear panel facing the front of the rack fixture, remove only those screws from the set of holes that will be toward the front of the rack. Attach the two rack ears using the enclosed screws.

Bench Top

If bench-top assembly is required, install the self-adhesive rubber feet on the bottom of the unit approximately one inch from each corner.

Power-Up Activation

At initial power-up or on the *Reset Power-On* (*R) command, the TempScan/1100 or MultiScan/1200 performs automatic self-tests to ensure that it is fully functional. The front panel LED indicators show any errors if they occur. Possible error conditions and their corresponding LED indicator patterns are shown in the following table. Any LED pattern not shown is an internal error that is not field-serviceable; in this case, contact the factory. If ERROR is on by itself, there is a configuration error due to setup information in NV-RAM. Check the error using the *Query Error Status* (E?) command.

Error Condition	LED Indicators				
	TALK	LISTEN	SRQ	ERROR	POWER
No Errors	(Off)	(Off)	(Off)	(Off)	ON
General Hardware Failure	ON	(Off)	ON	FLASHING	ON
Position-U22 ROM Invalid	(Off)	(Off)	(Off)	FLASHING	ON
Position-U21 ROM Checksum Error	(Off)	(Off)	ON	FLASHING	ON
Position-U22 ROM Checksum Error	(Off)	ON	(Off)	FLASHING	ON
Non-Volatile RAM Error	ON	(Off)	(Off)	FLASHING	ON
Dynamic RAM Error	ON	ON	(Off)	FLASHING	ON
Interprocessor COM Error	ON	ON	ON	FLASHING	ON

If no problems are found, the *POWER* LED indicator will remain on while the rest of the indicators will go out, and the TempScan/1100 or MultiScan/1200 will begin its power-up initialization. This self test is performed each time the unit is powered up regardless of whether power-on was caused by the power switch or the *Reset Power-On* (*R) command. During initialization, the self test performs the following steps:

1. Checks for errors at power-up.
2. Checks the flag in the NV-RAM to determine if it should power-up with factory default settings or a user-defined configuration.
3. Loads appropriate registers with corresponding values in NV-RAM.
4. Checks a flag to see if alarms should be enabled at power-up, and if so, enables them.
5. Loads channel configuration registers.
6. Loads program sequencer with appropriate channel configurations.
7. Resets computations processor to begin acquiring scans.

The self test takes approximately five seconds to complete, after which the TempScan/1100 or MultiScan/1200 unit is ready for normal operation.

For more information, see section *Power-Up Configuration* in the chapter *System Configuration*.

Introduction	55	
Groups, Charts & Channels.....	56	
Using ChartView.....	56	
What ChartView Provides.....	58	
ChartView Main Window	58	
Channel Information Region.....	60	
Status Indicator Region.....	61	
Main Window Toolbar	62	
Group Select.....	62	
Start, Pause & Stop Charts.....	62	
Scroll Faster & Scroll Slower.....	63	
Display Configuration Setup.....	63	
Channel Configuration.....	69	
PostView post-acq data viewer.....	69	
Arm Acquisition.....	69	
Disarm.....	69	
Print Charts.....	70	
Main Window Pull-Down Menus	70	
File Menu.....	70	
Chart Menu.....	71	
View Menu.....	72	
Acquire Menu.....	73	
Data Menu.....	73	
		Window Menu.....75
		Device > Interface >.....76
		Device > Status >.....77
		Device > Configuration >.....79
		Setup Menu.....79
		Bar Graph, Analog & Digital
		Meters
		80
		Overview.....80
		Bar Graph Meters.....80
		Analog Meters.....81
		Digital Meters.....82
		Meters Toolbars.....83
		Meters Pull-Down Menus.....83
		Meters Configuration Menu.....84
		Configuring a Meter.....84
		Setup Window
		85
		Channel & Alarm Setup Dialog Box.....85
		Acquisition Setup Dialog Box.....88
		Data Destination Dialog Box.....91
		Chart Setup Wizard
		93
		Introduction.....93
		Automatic Chart Creation.....94
		Bypassing Automatic Chart
		Creation.....95

Introduction

ChartView is a graphic Microsoft Windows-based program which can be used for various data acquisition applications. The program was designed for *ease-of-use* with no need for programming or expertise in configuration. *ChartView Plus* provides enhanced features – including overlapping channels (up to four overlapping channels per chart), alarm logging, multiple groups, and Auto Re-arm – which can be activated by the use of a registration ID number. Please consult your service representative for more detailed information.

ChartView and *ChartView Plus* provide you with the capability to connect to and control any member of the TempScan/1100 or MultiScan/1200 family of data acquisition instruments, as well as perform the following tasks:

- Create and edit chart display setups.
- Set up analog input parameters (selecting Channels, Channel Types, Units) to acquire data.
- Configure alarms (and log alarms with ChartView Plus).
- Configure and arm an acquisition.
- View real-time display of channel data via the Main Window and Meters indicators.
- Save data to disk.
- Transmit data to Microsoft Excel via DDE (Dynamic Data Exchange).
- Start PostView, an independent application that allows you to graphically view post-acquisition channel data from a file.
- Use remote RS-232 communications by attaching the acquisition device to a modem configured for Auto Answer.

An understanding of the following basic concepts will help you master *ChartView* more quickly, and should be understood before starting the program.

Groups, Charts & Channels

When starting the program with no configuration file present (see Chapter 1 if necessary), a feature called *Chart Setup Wizard* is automatically activated to assist you with your display setup. To make the best use of *Chart Setup Wizard* you need to understand the relationship of Groups, Charts, and Channels.

Group. “Group” refers to a group of charts. Note that *ChartView* program makes use of one chart group. *ChartView Plus* allows up to 64 groups, depending on the capabilities of your PC, but can only display one group at a time.

Chart. “Chart” refers to display area which reflects real-time channel data values for a selected channel and can be scrolled at various rates. You can assign up to 16 charts per group. *ChartView Plus* enables each chart to display up to four overlapping channels.

Channel. “Channel” refers to a signal channel. Channels will be displayed in units of C, F, K, R, mV, V, or in user-defined units, depending on the configuration and type of signal conditioning card used. With *ChartView Plus* you can have up to 4 overlapping channels assigned to one chart.

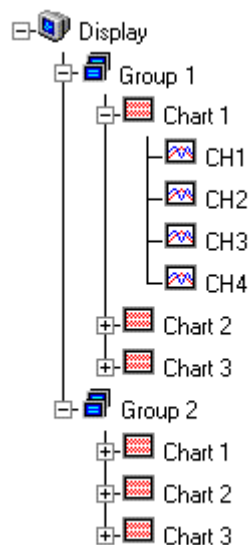

Using ChartView

Charting vs. Acquisition To-Disk. ChartView has two distinct operations; displaying real-time data and saving collected data to disk. These two operations are completely independent of one another. As such, ChartView can display data in its real-time indicator without arming a "to-disk" acquisition, or it can arm a "to-disk" acquisition without displaying the data in its real-time indicators.

Regardless of the state of the to-disk acquisition, when enabled, the real-time indicators, including the charts, always display the current channel values. Regardless of whether the to-disk acquisition is disarmed, waiting for trigger, or in the post-trigger state, the channel values viewed in the real-time indicators always reflect the current values of the channels.

Hardware/Software Interaction & Stand-Alone Operation. The intelligent acquisition hardware handles all aspects of the acquisition, including triggering, scan timing, and data buffering. ChartView simply provides a method for the user to configure the data collection parameters and download them to the hardware. Once the hardware is configured, it has the capacity to perform the acquisition without computer intervention. As the instrument collects the data, it stores it in its internal buffer in preparation for uploading it to the computer.

As a default, when a to-disk acquisition is armed, ChartView constantly polls the instrument, uploading available scans and storing them to disk. This polling operation, however, can be disabled so that the instrument will operate in a totally stand-alone mode, buffering scans in its internal buffer indefinitely. As its internal buffer becomes full, it posts a buffer overrun error and continues to store scans, overwriting the oldest data in the buffer.

If ChartView's polling feature has been turned off, ChartView can be directed at any time to upload the instrument's current buffer contents and save it to the disk file. If you turn on the polling feature, ChartView will upload the instrument's current buffer contents, then continue to poll the instrument, uploading the instrument's newly buffered data periodically.

Some of the data acquisition scenarios that pertain to ChartView are as follows:

1) Waiting for Trigger

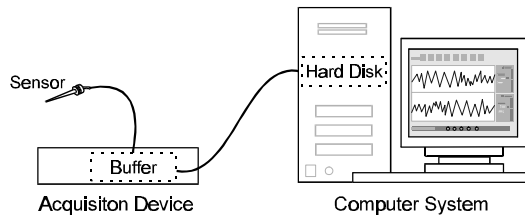

Data is received by acquisition device, but not stored. Selected channels for display can be viewed graphically in scrolling charts, as well as in one or more meters (analog, digital, or bar graph).

2) Acquiring & Uploading Acquisition

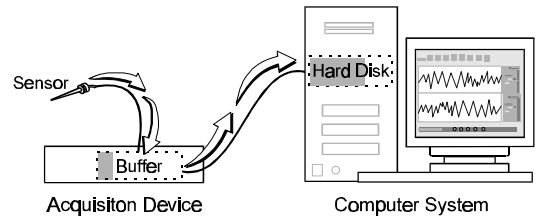

Device has been triggered. Data is temporarily stored in device buffer prior to being uploaded to PC system hard disk. As in the first scenario, selected display channels can be viewed.

3) Buffering Acquisition in Instrument

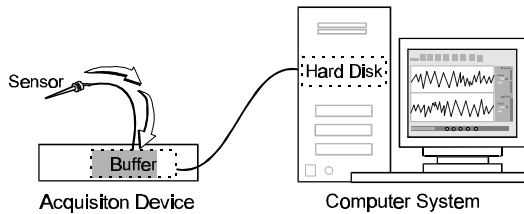

Acquired data (from point of trigger) is received by acquisition device and temporarily stored in device buffer. As in the previous scenarios, selected display channels can be viewed.

4) Uploading Data from Instrument Buffer

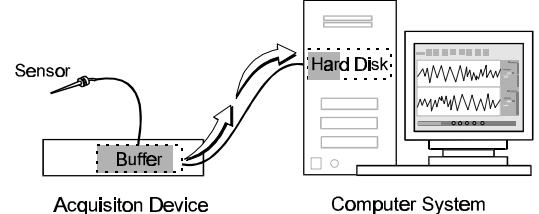

Acquired data is uploaded to the PC hard disk from the device buffer. As in the previous scenarios, selected display channels can be viewed.

Four Basic Data Acquisition Scenarios

What ChartView Provides





ChartView and *ChartView Plus* provide you with the capability to connect to, and control any member of the TempScan/1100 or MultiScan/1200 family of data acquisition instruments, as well as to:

Create and edit chart display setups	See <i>Display Configuration</i> , beginning on page 63 and <i>Chart Setup Wizard</i> , beginning on page 93.
Set up analog input parameters (selecting: Channels, TC types, Units) to acquire data.	See <i>Setup Window</i> , beginning on page 85.
Configure alarms, log alarms.....	See <i>Device > Status</i> , page 77, <i>Setup Window</i> , page 85, and <i>Channel Configuration Columns</i> , page 87.
Configure and arm an acquisition.....	See <i>Acquisition Setup Dialog Box</i> , page 88.
View real-time display of channel data via the Main Window....	See <i>ChartView Main Window</i> , beginning on page 58.
Save data to disk.....	See <i>File Menu</i> , page 70 and <i>Data Destination</i> , page 91.
Transmit data to Microsoft Excel via DDE (Dynamic Data Exchange).	See <i>Data Menu</i> , beginning on page 73.
Start <i>PostView</i> , an independent application that allows you to... graphically view data channels from a file.	See chapter <i>PostView</i> on page 141.
Use remote RS-232 communications by attaching the acquisition device to a modem configured for Auto Answer	See <i>Device > Interface</i> , page 76.

ChartView Main Window

While using this chapter, refer to the Main Window figure and its associated control option table as needed. Because of the graphic aspect of the window, you should be able to develop a good understanding of the program's capabilities and associated operating techniques within a very short time.

The following comments apply to the figure and table on the following page.

- In regard to the control option table presented on the facing page, the symbols:  (mouse), , , and [spacebar] are control options which allow you to tab to a field and make changes with the specified control.
- *Channel Selection* (14) can also be made by tabbing to the *Center Control* (17) or *Units/Div Control* (18) and using *PageUp* or *PageDown* ().
- The *min and max scale values* (13) and (19) are automatically generated, but can also be set from the Chart Setup Dialog.
- You can use the Chart pull-down menu to turn grid limit lines Off, or On. Limit lines can be solid or dots.
- In regard to the time stamp (region 21), if you stop the chart the time stamp will begin at 00:00:00 upon restarting the chart (if using relative time), or at the real clock time (if using absolute time).
- More detailed information regarding the pull-down menus and toolbar buttons is provided throughout the chapter.

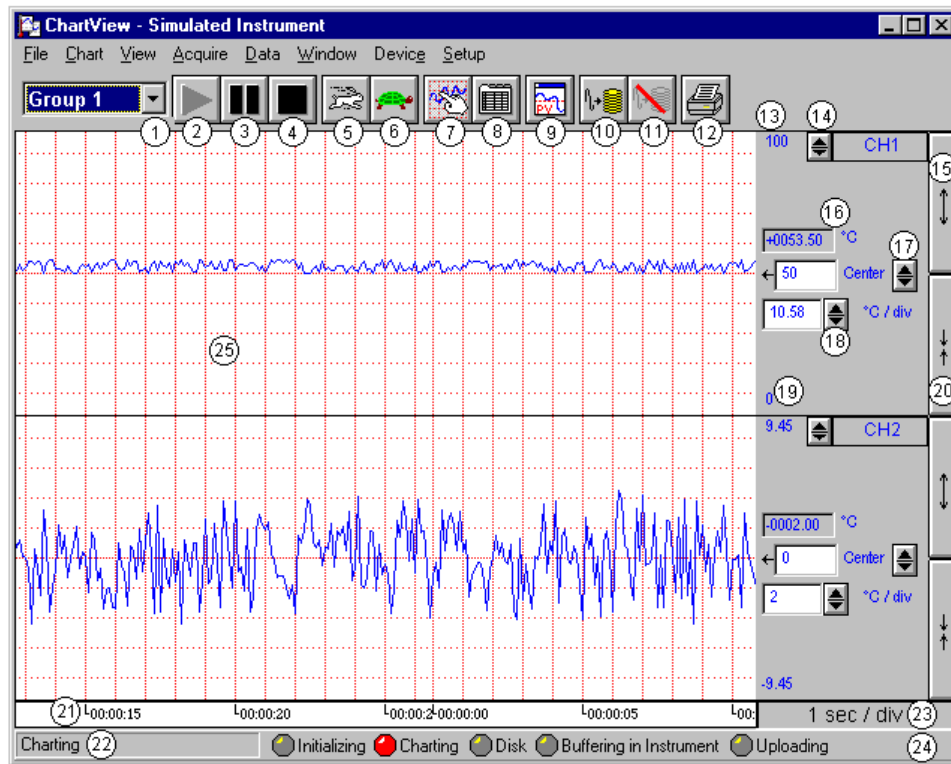

ChartView Main Window and Control Options

☞ = Mouse, ⇅ = Arrow Keypads, ⏴ = PageUp/PageDown Keypads		
1	Group Select	Ctrl+G, or ⇅, or ⏴
2	Start Charts and Indicators	☞ or, F5
3	Pause Charts	☞ or, F7
4	Stop Charts	☞ or, F6
5	Scroll Faster	☞ or, Ctrl+Z
6	Scroll Slower	☞ or, Ctrl+X
7	Display Configuration	☞ or, Pointer over chart and "right-click" Current group will be selected.
8	Channel Configuration	☞
9	PostView post-acq data viewer	☞ or, Windows Pull-down menu
10	Arm Acquisition	☞ or, Ctrl+T
11	Disarm ...	☞ or, Ctrl+Y
12	Print Charts	☞ or, Ctrl+P
13	Chart Max. Scale Value (Grid Limit Line)	From Chart Pull-down menu or Chart Setup Dialog Box
14	Channel Selection	☞ or, ⇅
15	Multiply (x2)	☞ or, Tab-to/Spacebar
16	Present Value of Selected Channel	N/A
17	Center (Value at Chart Mid-Line)	☞ or, ⇅, or type-in
18	Units/Division (Vertical increment per one grid box)	☞ or, ⇅, or type-in
19	Chart Min. Scale Value (Grid Limit Line)	From Chart Pull-down menu or Chart Setup Dialog Box
20	Divide (÷2)	☞ or, Tab-to/Spacebar
21	Time Stamp (hr:min:sec)	Thru Pull-Down Menus only
22	Status Message Box	N/A
23	Time/Division (Chart Speed), the Horizontal increment per grid box	Ctrl+Z (Faster) Ctrl+X (Slower)
24	Status LEDs	N/A for Windows 3.1.
25	Chart Display	☞ Double-click left mouse button in selected chart to zoom in or zoom back out. Right-click to bring up Chart Setup Dialog Box with the current group and target chart selected.

Channel Information Region

Channels can return values in units of C, F, K, R, mV, V, or *user defined* units (if the mX + b option is used). With exception of mX + b *user defined* units, units depend on the configuration and type of signal conditioning card used. Signal conditioning cards are detailed in the user's manual for your data acquisition device. The Channel Information Region is located on the right-hand side of *ChartView*'s main window. The values displayed in this region are the real-time values of the selected channel.

By clicking on the up or down arrows (▲, or ▼) by the channel selection box (item 14), you can select one of a maximum of 4 channels that were assigned to that chart. You could then observe the chart-related information for that specific channel. You can also select a new channel for the information region by placing the cursor in (or tabbing over to) the "Center" or "Units/Div" fields and then pressing PageUp or PageDown. This is particularly useful when your main window has been re-sized such that the channel selection boxes are not visible.

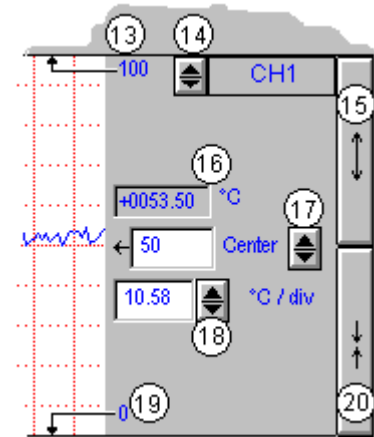

The following list identifies the various areas of the region.

13	Chart Max. Scale Value (Grid Limit Line)	17	Center (Value at chart mid-line)
14	Channel Selection (Of chart's available channels)	18	Units/Division (Provides the vertical increment of one grid box.)
15	Multiply (x2)	19	Chart Min. Scale Value (Grid Limit Line)
16	Present Value	20	Divide (÷2)

Note: The basic *ChartView* program does not permit overlapping channels or having more than 1 chart group. Multiple group applications (*ChartView Plus*) can be activated by use of a special code, allowing up to 4 overlapping channels per chart. Regardless of whether you are using the basic *ChartView* program, or *ChartView Plus*, there is a maximum limit of 16 charts per group.

Multiply and Divide Buttons - In addition to reading channel values, you can increase or decrease the size of the selected channel's chart. This is accomplished with the **Multiply** (15) and **Divide** (20) push-buttons. The Multiply push-button effectively increases the size of the selected channel's chart by a factor of 2, while automatically adjusting the chart's high and low values (items 13 and 19). Aside from "clicking" on the Multiply/Divide controls, you can use your keyboard spacebar to control this feature once the button (15 or 20) is selected. Selection may be with mouse, or by tabbing over to the control.

Making changes to a channel's chart parameters does not affect the parameters of the other channels, with the following exception: Holding the keyboard's control key down while adjusting either spinner (▲/▼) for *center* (item 17), or spinner for *units/div* (item 18) causes the parameter change to apply to all channels displayed for the chart, not just the currently selected channel display. This feature applies to the spinners and keyboard up and down arrow keys, but not to the text input.

Center Control - The **Center** control (item 17) changes the value of the selected channel's chart centerline. Changing the value of *center* results in an automatic change of the chart's high and low end values (items 13 and 19), and possibly an automatic change of the units/div (item 18). Aside from using the *center* spinner controls to change center, you can change the center value by placing the mouse cursor in (or tabbing over to) the field and then either typing in the desired value, or using the PC keyboard up and down arrow control keys.

Units/div - The units in **units/div** (18) can be C, F, K, R, mV, or V. The division referenced is one vertical grid. In the example above for Channel 1, each vertical grid increment represents 10.58°C per division. Changing the units/division spinner controls (▲/▼) will result in an automatic adjustment of the max scale and min scale values (items 13 and 19). Aside from using the units/div triangular controls to change the value, you can change units/div by placing the mouse cursor in (or tabbing over to) the field and then either typing in the desired value, or using the PC keyboard arrow control keys.

Status Indicator Region



The status indicator region of the Main Window, located along the bottom of the window, consists of the following items:

- | | | | |
|----|--------------------|----|--------------------------|
| 21 | Scrolling Time | 23 | Chart Speed (Time/Div) |
| 22 | Status Message Box | 24 | Status LEDs ¹ |

Scrolling Time - Scrolling Time (21) is turned On or Off from the View pull-down menu. Time Stamp can be “absolute” (real time) or “relative.” Absolute time is based on your computer clock, whereas relative time starts at 00:00:00 hours/minutes/seconds, and then continues timing in increments relative to the Chart Speed (23). The Absolute or Relative time stamp style is selected from the Chart pull-down file.

Status Message Box - The Status Message Box (22) informs you of the status of the data acquisition device. Several sample messages appear below:

Sample Status Messages

- | | |
|-------------------------------------|---|
| Attaching to device ... | Trigger device. Setting acquisition parameters. |
| Setting channel configuration ... | Acquisition active. Updating active. |
| Setting the acquisition parameters. | Acquisition active. No updating. |
| Charting ... | Waiting for trigger ... |

Chart Speed - Chart Speed (23) consists of a “time per division” value which can be changed using the “faster” (rabbit) button or “slower” (turtle) button. Fourteen possible chart speeds are as follows:

0.1 sec/div	1 sec/div	10 sec/div	2 min/div	30 min/div
0.2 sec/div	2 sec/div	30 sec/div	5 min/div	1 hr/div
0.5 sec/div	5 sec/div	1 min/div	10 min/div	

Status LEDs¹ - *ChartView* s Main Window contains five virtual LEDs (item 24) for conveying the state of the system. Each of the five indicators is labeled on the main window. These indicators are:

- Initializing:** Indicates *ChartView* is configuring the data acquisition instrument.
- Charting:** Indicates that charting is in progress. This indicator is useful when charts are scrolling at a very slow speed.
- Disk:** Indicates *ChartView* is writing to disk.
- Buffering in Instrument:** Indicates the data acquisition instrument is storing scans that are not being saved to disk.
- Uploading:** Indicates that data in the instrument is being uploaded to the PC.

Note 1: The *Status LEDs* and their labels (listed above) do not appear when using Windows 3.1. However, when using Windows 3.1, the labels will appear at the time the function is active, e.g., when uploading, the text [Uploading] shows in region 24. This text message is in addition to the text in the *Status Message Box* (Item 22).

Main Window Toolbar

Each item in the toolbar, with exception of Group Select (1), is represented by an individual button icon and is also accessible from the pull-down menu (discussed later). Placing the cursor on the button and clicking the mouse button enables the tool, or opens a corresponding dialog box. Each Toolbar button has a pop-up label that appears when the mouse is placed over the button.

Note: The toolbar represented below is for *ChartView s* Main Window. Separate toolbars exist for Bar Graph, Digital Meters, and Analog Meters options (selectable from the Windows pull-down menu.) These other toolbars are discussed later in the chapter.



- | | | | |
|---|-----------------------------|----|-------------------------------|
| 1 | Group Select | 7 | Display Configuration |
| 2 | Start Charts and Indicators | 8 | Channel Configuration |
| 3 | Pause Charts | 9 | PostView post-acq data viewer |
| 4 | Stop Charts | 10 | Arm Acquisition |
| 5 | Scroll Faster | 11 | Disarm ... |
| 6 | Scroll Slower | 12 | Print Charts |

Group Select



This feature indicates the chart group which is being charted. Clicking on the down arrow (▼) reveals other chart groups configured by the user. The standard *ChartView* program allows the use of only one chart group, while *ChartView Plus* can be configured to display up to 64 groups (one group at a time). To select a different chart group, simply pull down the group list and select the desired group. The group list can be obtained by any of the control options provided in the *Main Window* table. These are: a) clicking the down arrow (▼), b) using Ctrl + G on the keyboard, c) using the keyboard up or down arrow key, d) using the page up or page down key. If using a control option other than “a,” you may need to select the *group select* box by repeatedly pressing the keyboard’s *Tab* key until the *group select* box is selected. When this happens the name of the currently selected group appears in white on a dark background.

Start, Pause & Stop Charts



As their names imply, these three buttons are used to start, pause, or stop the charts. Pressing “pause” suspends chart scrolling, but does not stop the “charting” process. While “pause” is pressed, the channel region of the main window will continue to display real time values. Pressing “pause” a second time restarts the scrolling action. Pressing “stop” causes the charting process to stop and instantly freezes the channel region at its present values. This does not affect the acquisition.

Scroll Faster & Scroll Slower



These buttons provide a means of speeding up and slowing down the chart's scrolling rate, also referred to as chart speed. These two buttons do not affect the scan rates of the acquisition device. The chart speed (item 23) is indicated in the lower right-hand corner of the main window as time/div. There are 14 possible chart speeds, as follows:

0.1 sec/div	1 sec/div	10 sec/div	2 min/div	30 min/div
0.2 sec/div	2 sec/div	30 sec/div	5 min/div	1 hr/div
0.5 sec/div	5 sec/div	1 min/div	10 min/div	

Display Configuration Setup



The Display Configuration button accesses a *Display Configuration Setup* dialog box. This box will also be displayed if: a) *Create Charts Manually* is selected during use of the Wizard Chart Setup program, b) you select Setup from the Chart pull-down menu, c) you right-click on the chart region in *ChartView's* Main Window.

Note: If multiple chart groups are present in the display configuration, the current group will be selected in the display configuration tree.

When you first click on the Display Configuration button, a *Display Configuration Setup* box appears. A display region shows the configured structure of the groups, charts, and channels. From this box you can select the number of charts to be assigned to a specific group. With the use of the mouse cursor you can also select a chart or channel for additional editing.

In addition to the text presented in the following sub-sections: ***Normal Edit*** and ***Manually Creating a Display***, you can refer to the following for related information: *Chart Setup Wizard* on page 93 provides information on the use of *Chart Setup Wizard* for the set up of groups, charts, and channels.

The method you use to access the *Display Configuration Setup* window makes a difference. When you use the toolbar button or the pull-down menu's Setup selection, the *Display Configuration Setup* window appears with *the current chart display configuration intact*. With this type of access you would simply edit your existing chart display. Channel and alarm configurations do not change, with exception that newly displayed channels will be enabled.

When you access the Display Configuration Setup from the *Chart Setup Wizard*, the *Display Configuration Setup* window appears with no existing display. This allows for a "clean slate" approach to creating a chart display, as opposed to an "editing" approach. Channel and alarm configurations do not change, with exception that newly displayed channels will be enabled.

Normal Edit

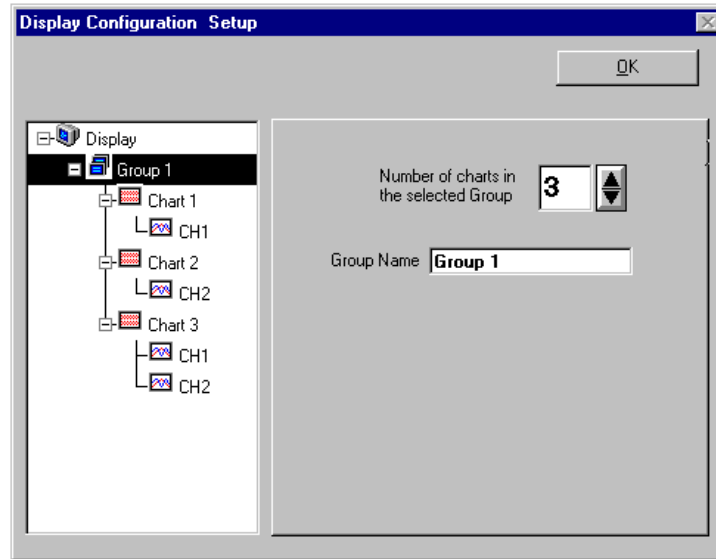

Display Configuration Setup Dialog Box with an Existing Configuration

To explain editing a configuration, we make use of an example in which assumes you want to edit Chart 1. In the following figure, Chart 1 was highlighted by clicking on it with the mouse cursor. The *Display Configuration Setup* box then changed, allowing you to see specific channel types (such as volts only) or to “Show all Types,” as in the example. From this setup box you can add or delete charts and channels. You can:

- hold down the *Shift* key and use the *cursor* to select several consecutive channels for addition or deletion
- hold down the *Ctrl* key and use the *cursor* to select several non-consecutive channels for addition or deletion
- double-click on an *available channel* to add it to the selected channels
- double-click on a *selected channel* to remove it from the selected channels list

Note: When a chart contains overlapping channels and the channels share values such that their traces reside on top of each other, then the channels that are listed lower in the display list (the most recently added channels) will obscure the channels higher in the list (those which were added first).

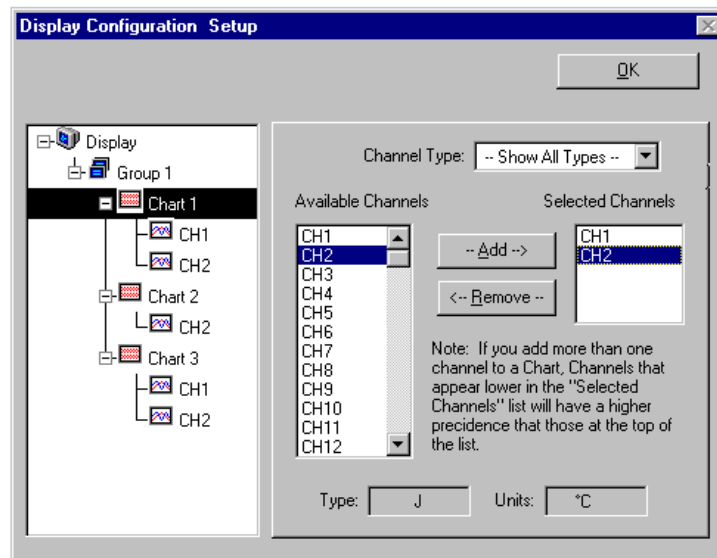

Adding Channel 2 to Chart 1

Another variation of the Display Configuration Setup box appears when you highlight a channel. In the following figure, Channel 1 (of Chart 1, Group 1) was selected, resulting in a new screen image. From this screen you can edit the channel setup.

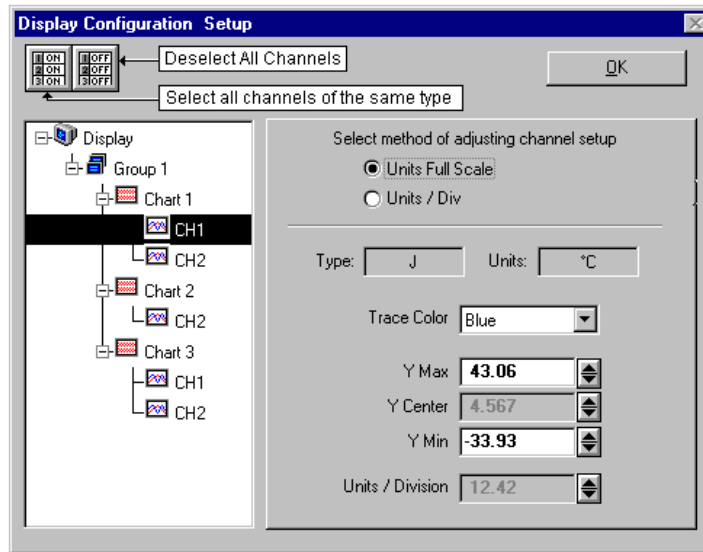

Adjusting Channel Setup for Channel 1

ChartView and *ChartView Plus* data channels can operate in one of two modes: Units Full Scale or, Units/Div. The mode is selected by radio button.

Units Full Scale. When Units Full Scale is selected, as depicted in the above figure, you can alter Y Max and Y Min. These are the upper and lower limits of the Channel as they will appear on the chart when the channel is selected. When you change either parameter, Y Center and Units/Division are automatically adjusted. You can not directly adjust Y Center or Units/Division while “Units Full Scale” is selected. You can change Y Max and Y Min by using the up and down arrows, or by highlighting the existing value, typing in the new value, the pressing “Enter” on your PC keyboard.

Note: If the window size is changed, a chart operating in the Units Full Scale mode will maintain its *full scale* setting across the chart.

Units/Div. When Units/Div. is selected you can alter Y Center and Units/Div. Y Center is the centerline value of the chart when the channel is selected. Units/Div. is the vertical value of on chart grid increment. When you change Y Center or Units/Div. Y Max and Y Min are automatically adjusted. You can not directly adjust Y Max or Y Min while “Units/Div.” Is selected. You can change Y Center and Units/Div. by using the up and down arrows, or by highlighting the existing value, typing in the new value, the pressing “Enter” on your PC keyboard.

Note: If the window size is changed, a chart operating in the Units/Div. Mode will maintain its *units per division scale* setting across the chart.

The channels in the display setup you create will be automatically enabled and will appear in chart form on *ChartView*’s Main Window. The Channels will overlap on their assigned Chart (for *ChartView Plus* applications), and will be visible when the applicable Group is selected. Note that only one group of charts can be viewed at a time.

It is important to understand that other channels (those not in the display setup) maintain their existing configuration status. They are not affected by the edit of the configuration display. You can enable additional channels from the Channel and Alarm Setup window. Enabling additional channels allows you to acquire more data; however, it will not change your display on *ChartView*’s Main Window. In other words, you can also acquire data from channels which you do not monitor.

Manually Creating a Display

For *ChartView Plus* users, if you plan to have a chart setup which is not weighted evenly, i.e., different numbers of channels per chart and different numbers of charts per group, you may want to manually setup your chart display from scratch, that is, without beginning from a pre-existing display configuration. This method is arrived at from the *Chart Setup Wizard* window by selecting “Manual Chart Creation.” When this button is clicked, the program exits the *Chart Setup Wizard* and enters the manual method of Display Configuration Setup. Although this method is referred to as “manual,” it still contains some automatic elements, such as *Automatically Add Groups to the Setup* (available with *ChartView Plus*).

Note: Even if an unevenly distributed chart display is desired, you can always edit a pre-existing chart setup, or create a new setup by one of the *Chart Setup Wizard*’s automatic methods, and then edit the setup.

To manually setup your chart display, using the “clean slate” approach as opposed to “editing an

1. Select Wizard from the Chart pull-down menu of *ChartView*’s main window. The New Display Setup dialog box appears.

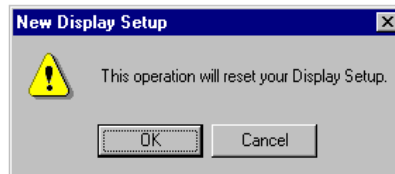

2. Click OK on the New Display Setup dialog box. The Wizard setup window appears (see following figure)
3. Click on the Manual Chart Creation button. The Display Configuration Setup box appears. Since the previous display configuration was reset, no groups or charts are seen in the display area on the left side of the screen.

Note: If you have *ChartView Plus*, you will be allowed to have more than one group, as well as overlapping channels (up to four per chart). If you have the basic *ChartView* program you will be limited to one group, and only 1 channel per chart.

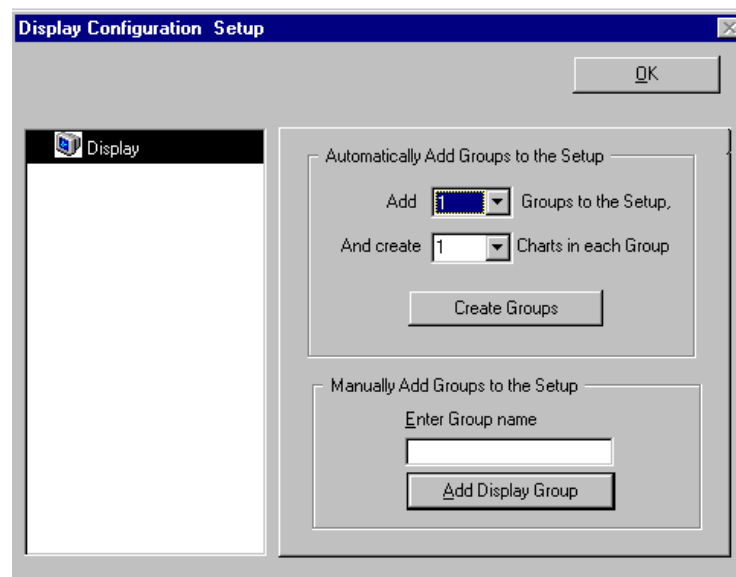

- As seen in the previous figure for the “Clean Slate” approach, you have two options at this point. Perform (4a) or (4b) as appropriate. With *ChartView Plus*, option (4a) is typically used.

(4a) *Automatically add groups to the setup.* Enter the number of groups and charts desired by using the cursor and typing in the value, or by using the pull-down arrows (▼) and making the appropriate selections; then click on the Create Groups button.

(4b) *Manually add groups to the setup.* Type in the name of the chart group; then click on the Add Display Group button.

The Display Configuration Setup screen changes to show chart groups, and the number of charts for the selected (black highlighted) chart group. From this screen you can change the number of charts in a group, as well as change the group name.

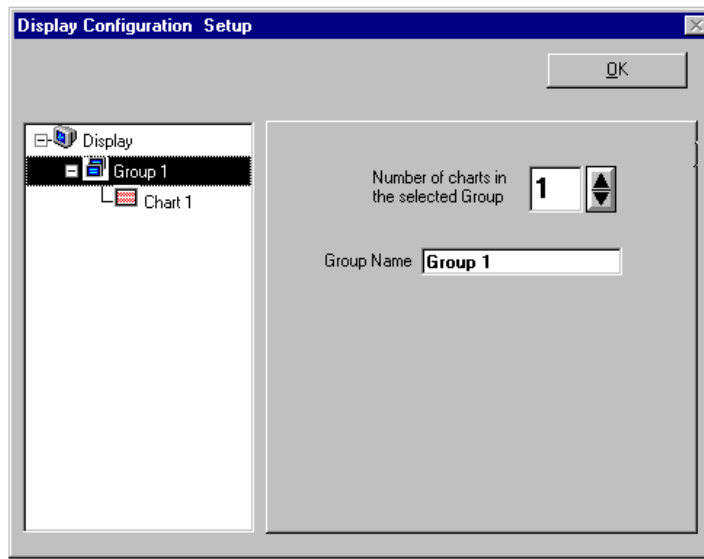

Adding a Chart to Group 1

- Change the number of charts per group if desired.
- Change the group name if desired.
- Click on a group to see the chart(s) assigned to the group. In the above example there is one group with one chart.
- Click on a chart to assign channels to the chart. A screen similar to the following will appear.

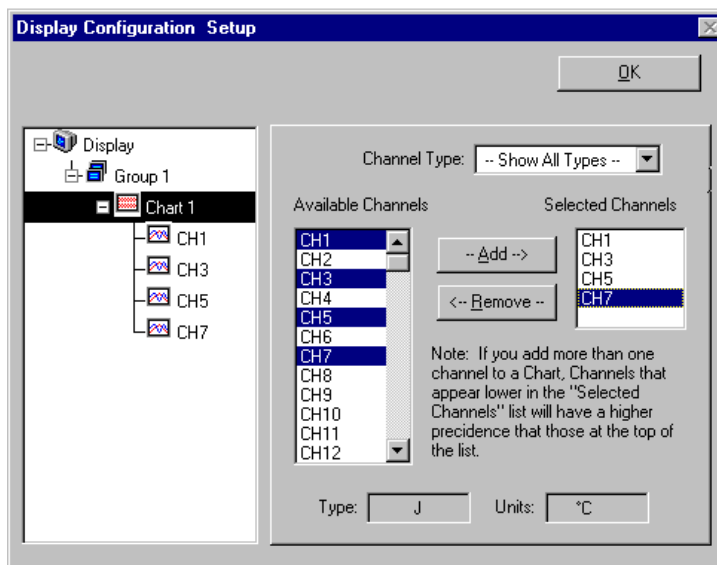

Assigning Channels to Chart 1 of Group 1

9. Choose channels for the selected chart. With *ChartView Plus* you can select up to 4 overlapping channels per chart. With the basic *ChartView* program you are limited to one channel per chart. There are four methods of adding channels. These are as follows:
- Highlight an available channel using the cursor and left-hand mouse button; then click the Add button. Repeat for each channel to be added.
 - Double-click on the channel (in the available channels list to add; in the selected channels list to remove)
 - Hold down the keyboard's *Shift Key* and use the left-hand mouse button to select a block of consecutive available channels (up to 4); then click the Add button. Example: CH3, CH4, CH5,CH6.
 - Hold down the keyboard's *Ctrl* button and use the left-hand mouse button to select up to 4 available channels (these can be non-consecutive); then click the Add button.
 - Example: CH1, CH3, CH5, CH7, as in the previous figure.
- Note:** You can also remove channels in a similar manner by highlighting a channel(s) in the Select Channels box, and then clicking on the Remove button. In the previous figure, CH7 (in the select box) is highlighted. Clicking the Remove button would delete that channel from Chart1.
- Note:** When a chart contains overlapping channels and the channels share values such that their traces reside on top of each other, then the channels that are listed lower in the display list (the most recently added channels) will obscure the channels higher in the list (those which were added first).
10. In the display area (on the left-hand side of the screen) click on a channel to check the channel's configuration and to re-configure the channel, if desired. The *Display Configuration Setup* Window will appear similar to that in the following figure.
- Note:** Changing the display configuration does not change the existing channel and alarm configuration. It only changes how the chart groups, charts, and channels will be displayed.

This screen contains two “radio buttons” for selecting the method of adjusting the display mode and channel setup. It is the same screen that was discussed in the sub-section, *Editing an Existing Display Configuration*. From this screen you need to choose *Units Full Scale* or *Units/Div*. Each method was previously discussed in the section *Normal Edit* on page 64.

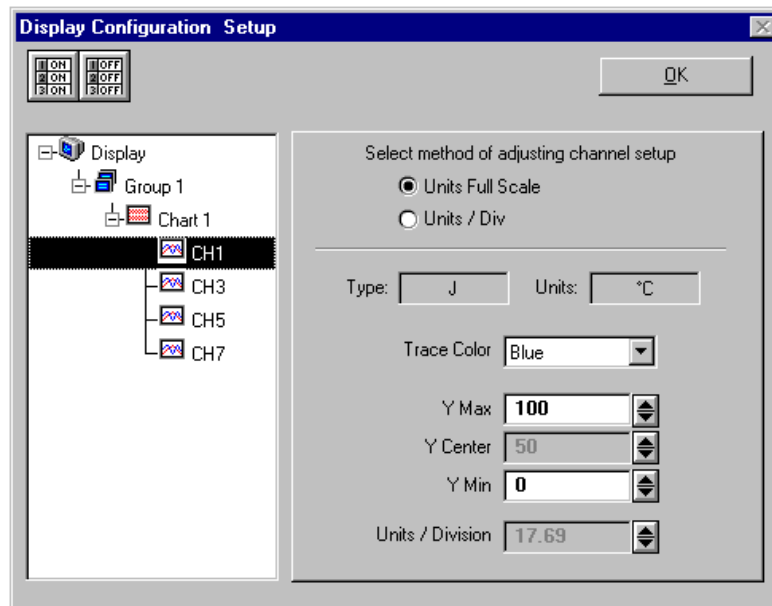

Adjusting Channel Setup for Channel 1

Remember, you can enable additional channels from the Channel and Alarm Setup window. Enabling additional channels allows you to acquire more data; however, it will not change your display on *ChartView's* Main Window. In other words, you can acquire data from channels which you do not monitor.

Channel Configuration



The “Channel Configuration” button brings up the Setup Window with one of three “tabbed” dialog boxes displayed: Acquisition Setup (page 88), Channel & Alarm Setup (page 85), or Data Destination (page 91). The information entered in the Acquisition Setup dialog box is used by the Arm Acquisition command to set up the acquisition of data to disk. When the trigger is satisfied, the scans are collected at the selected scan frequency and stored to disk in the designated file. The Channels & Alarms dialog box is used to configure channels and alarms; the Data Destination dialog box is used to assign a filename and folder location for data, select an Excel or binary format (.TXT or .IOT respectively), and to select optional Time/Date and/or Alarm Stamps (to be included in the data) if desired. You can tab back and forth from each one of these dialog boxes to the other.

PostView post-acq data viewer



“PostView post acquisition data viewer” button accesses the *PostView* program. This independent program allows you to view waveforms recorded by data acquisition programs such as *ChartView*, *ChartView Plus*, and *TempView*. PostView is detailed in Chapter 3 of this software guide.

Arm Acquisition



You can use the Arm Acquisition button to activate an acquisition. When you click on this button the system is “armed” to begin collecting data by a recognized trigger (as set in the acquisition setup dialog box.) Three cases are as follows:

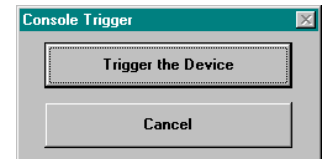

1. If there is no *Pre-trigger* defined, the *Trigger* option under the *Event Configuration* portion of the Acquisition Setup dialog box will determine when the Arm process is initiated.
2. When a Pre-trigger is defined, the Arm process is initiated as soon as the Arm Acquisition is selected.
3. If a keystroke is chosen as the trigger, the *Console Trigger* dialog box will appear when the Arm Acquisition is selected.

Disarm...



Use the “Disarm...” button to deactivate the data acquisition process at any point during an active acquisition. The following confirmation dialog box will appear when this item is selected.

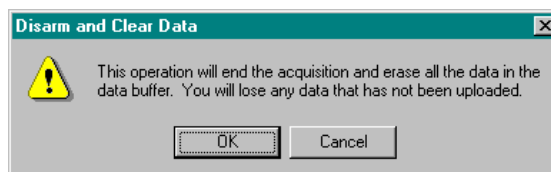

Print Charts



The Print Charts button activates a screen print of *ChartView s* main window.

Main Window Pull-Down Menus

The *ChartView* main window features several pull-down menus. As an alternative to the menus, you can enable several menu items by using **Toolbar** buttons, previously discussed. The items which are in common (between the pull-down menu and toolbar) are described in more detail in the **Toolbar** section.

File Menu

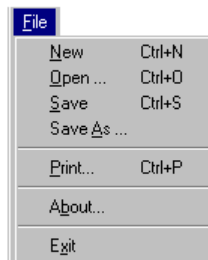

New (Ctrl + N)

Sets all channel parameters to their startup (factory default) setting.

Open (Ctrl + O)

Sets all channel parameters as directed by a specified configuration file (.cvw). The Load *ChartView* Setup window prompts you to select from a list of previously saved configuration files.

Save (Ctrl + S)

Saves the existing all-inclusive channel configuration settings for later recall. The Save command overwrites the existing version if the versions are named the same.

Save As

Saves the existing configuration for later recall; asks whether to overwrite the original version or save under a new filename.

Print (Ctrl + P)

The Print Charts button activates a screen print of *ChartView s* main window. Note that when a chart contains overlapping channels and the channels share values such that their traces reside on top of each other, then the channels that are listed lower in the display list (the most recently added channels) will obscure the channels higher in the list (those which were added first).

About

Clicking *About* will display a “*ChartView*” or “*ChartView Plus*” dialog box, as well as the software version number. *ChartView Plus* can be activated from the *ChartView* dialog box, upon entering a valid Registration ID Number and clicking the OK button. Your program can be registered through your service representative.

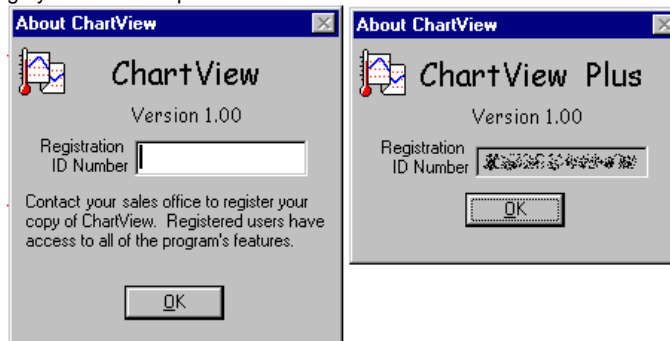

Dialog Boxes for ChartView and ChartView Plus

Exit

Exits the *ChartView* program.

File Menu Note

When *ChartView* is started for the very first time there is no default channel configuration file. In this case a *ChartView Startup* dialog box appears, providing you with the following four choices: *Retry*, *Select Device*, *Load File*, and *Exit Program*. After choosing *Select Device* a *Select Interface* dialog box appears, allowing you to choose IEEE 488, RS-232, or Simulated Instrument.

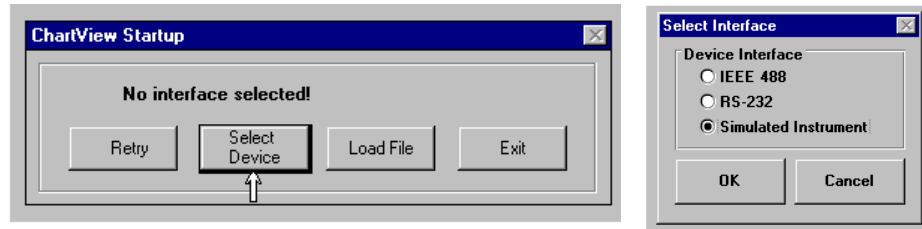

After the selection has been made, when *ChartView* is shutdown, the selected interface device and all channel configuration settings will be automatically saved in a default configuration file. Upon the next start of *ChartView*, the default configuration is automatically loaded.

If the default configuration becomes corrupt, or if you would like to bypass the default configuration when starting *ChartView*, you can hold down the *Shift Key* when starting *ChartView*. This causes the program to ignore the default channel configuration settings and causes the *ChartView Startup* dialog box to appear. This allows you to select *Load File* to make use of a specified channel configuration file from a previously saved configuration.

Chart Menu

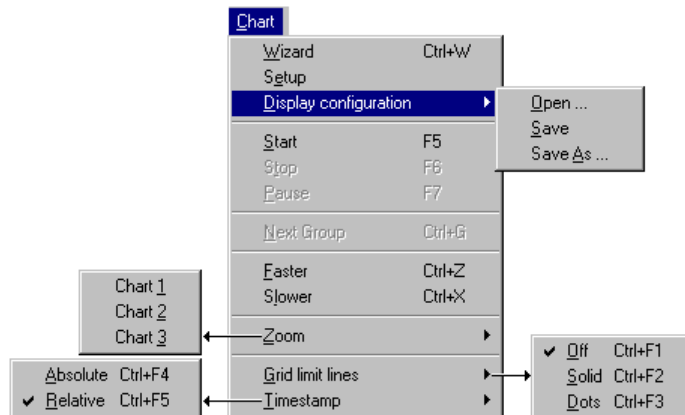

Wizard **Ctrl+W**

Accesses *Chart Setup Wizard* feature for automated chart configuration.

Setup

Accesses *Chart Setup* window, allowing you to edit your display configuration.

Display config.

Allows you to: Open a previously saved display configuration file, save the current display configuration file, or save the current display configuration file in a different location (or under a different file name). (See following note).

Note: There will be no default Display Configuration file present the first time *ChartView* is started. In this case *Chart Setup Wizard* activates, allowing you to create a display setup. When *ChartView* is shutdown, the display configuration is automatically saved in a default configuration file that will load upon the next startup of *ChartView*. If the default display configuration becomes corrupt, or if you would like to bypass this configuration when starting *ChartView*, you can hold down the Control Key when starting *ChartView*. This causes the program to ignore the default display configuration and await your creation of a new display.

Start F5 Starts, stops, or pauses chart scrolling.
Stop F6
Pause F7

Next Group Ctrl+G Selects the next chart group in the display configuration.

Faster Ctrl+Z Used to alter the chart scrolling speed. There are fourteen possible chart speeds. The range of speeds is from 0.1 sec/div to 1.0 hr/div.
Slower Ctrl+X

Zoom [Restore]
Zoom causes the Main Window to display one chart only. For example, if you were viewing 3 charts and desired to get a better view of Chart 2, you could use **Zoom** to view Chart 2 using the full chart viewing area, as compared to using one third of the area. The zoom feature can also be invoked by double-clicking in the chart region of the chart for which you want to apply the zoom. Once you have zoomed in on a chart, the pull-down menu Zoom option is replaced by a **Restore** option. Selecting **Restore** from the menu will return the main window to its previous multiple chart viewing status. The restore feature can also be invoked by again double-clicking in the chart region.

Grid limit lines Allows you to turn the chart's grid limit lines (items 13 & 19) on or off. If "on", you can have the grid lines appear as solid or dots.
Off Ctrl+F1
Solid Ctrl+F2
Dots Ctrl+F3

Timestamp Allows you to select an Absolute or Relative style of timestamp.
Absolute Ctrl+F4
Relative Ctrl+F5

View Menu

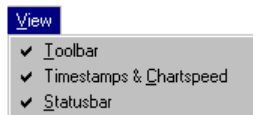

Toolbar A ✓ by Toolbar indicates the toolbar will be visible. The absence of the ✓ indicates the visible toolbar option is not chosen, and in this case will not appear on the Main Window. Use the mouse to select or de-select the toolbar option.

Timestamps & Chartspeed A ✓ by Timestamps & Chartspeed indicates that these options are selectable and visible. The absence of the ✓ indicates that the timestamp/chartspeed option is not chosen, and therefor not visible on the Main Window. Use the mouse to select or de-select this option.

Statusbar A ✓ by Statusbar indicates that the Status Message Box and Status LEDs are visible (items 22 and 24). The absence of the ✓ indicates that the status bar will not be visible on the Main Window. Use the mouse to select or de-select this option.

Acquire Menu

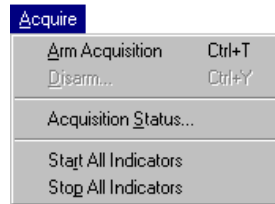

Arm Acquisition (Ctrl + T)

Arms the data acquisition device in preparation of receiving a trigger.

Disarm (Ctrl + Y)

Disarms the data acquisition device and discontinues the acquisition of data.

Acquisition Status...

Displays the condition of a data acquisition.

Start All Indicators

Starts all selected indicators for spreadsheet Reading column, Charts, and Meters.

Stop All Indicators

Stops all selected indicators for spreadsheet Reading column, Charts, and Meters.

Data Menu

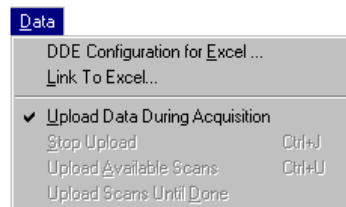

DDE Configuration for Excel

Configures the DDE (Dynamic Data Exchange) operation of *ChartView*. This pull-down menu allows you to dynamically load collected *ChartView* data into an open Excel spreadsheet. The three field regions are: Command Characters, Data Destination, and Timeout. These are discussed on the following page.

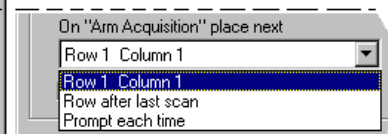
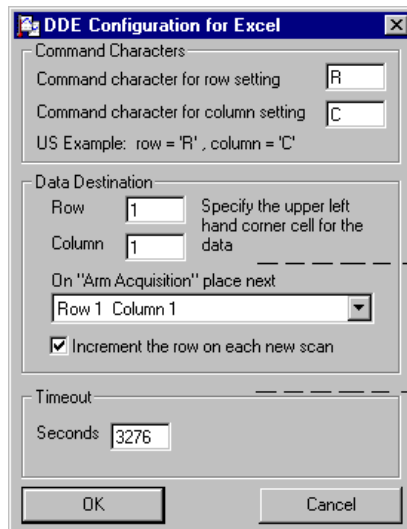

Command Characters	<p>This area contains two fields for entering command characters, one for row setting and one for column setting. Enter the characters (Excel parameters) to match the applicable version of Excel; for example:</p> <p style="margin-left: 40px;">France - Row = L, Column = C Germany - Row = Z, Column = S United States - Row = R, Column = C.</p>
Data Destination	<p><u>Assign the Data Destination.</u> This area allows you to assign the data destination on the Excel spreadsheet. Specify the data starting point by entering a number for row, and another for column. The two numbers designate the upper left hand corner cell of the Excel data entry.</p> <p><u>Positioning Data in Excel.</u> The data destination region also allows you to select one of three options in regard to positioning data in Excel on subsequent scans. Options are as follows:</p> <p>Row 1 Column 1. This selection starts the next scan at the designated row and column on the Excel spreadsheet. Changing the values in the "Row" and "Column" boxes (above figure) will automatically enter the new values in the corresponding fields of the "Row # Column #" placement assignment. For example, If you entered a 3 in the row box and a 5 in the column box you would see Row 3 Column 5, instead of Row 1 Column 1, in the above figure; and the next scan would start at row 3 column 5 in Excel.</p> <p>Row after last scan. When "Row after last scan" is selected the next scan will begin at the point in Excel where the previous acquisition left off.</p> <p>Prompt each time. When "Prompt each time" is selected, after each acquisition is completed a dialog box will ask if you want to <i>return to origin</i>. If you select "Yes", you will have an overwrite on the Excel spreadsheet, starting with the existing column and row designation. If you select "No," the next scan will begin on the spreadsheet's next row (from where the previous acquisition left off).</p> <p><u>Increment the Row on each new scan.</u> With this selected (✓), the Excel spreadsheet will use multiple rows, one row for each new data scan. With no check-mark, the spreadsheet will make use of one row only and will continue to display the latest scan information in that row.</p>
Timeout Region	<p>This field allows you to enter a DDE link timeout value from 5 to 3276 seconds. The value is how long the data import to Excel can be suspended while you perform a second Excel activity, such as displaying graphs. A screen message informs you when the DDE link is timed out, terminating the DDE link to Excel.</p>
<u>L</u>ink to Excel	<p>Creates DDE link to Excel spreadsheet. Note that Excel must already be running.</p>
<u>U</u>pload Data During Acquisition (automatic control)	<p>Enables <i>ChartView</i> to retrieve scans from device memory as data becomes available. The acquisition is active.</p>
<u>S</u>top Upload (Ctrl + J) (manual control)	<p>Stops <i>ChartView</i>'s transfer of data from the instrument to disk.</p>
<u>U</u>pload <u>A</u>vailable Scans (Ctrl + U) (manual control)	<p>Enables <i>ChartView</i> to access device memory for all scans currently available. Note that this function only uploads scans that are currently available and nothing else.</p>
<u>U</u>pload Scans Until <u>D</u>one	<p>Enables <i>ChartView</i> to access device memory and upload scans until scanning is complete.</p>

Window Menu

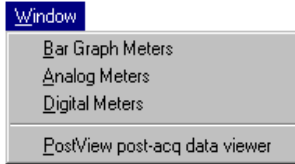

- Bar Graph Meters** Selecting Bar Graph Meters from *ChartView s* Window pull-down menu brings up the Bar Graph window. This window displays several channels in bar graph format. To activate the display, select the Start button in the meter toolbar. At least one meter must be assigned to an **active** (On) channel. You can select to view up to 32 meters at a given time. (See page 80).
- Analog Meters** Selecting Analog Meters from *ChartView s* Window pull-down menu brings up the Analog Meters window. This window displays several channels in a dial/gage format. To activate the display, select the Start button in the meter toolbar. At least one meter must be assigned to an **active** (On) channel. You can select to view up to 32 meters at a given time. (See page 81).
- Digital Meters** Selecting Digital Meters from *ChartView s* Window pull-down menu brings up the Digital Meters window to display several channels in numeric format. To activate the display, select the Start button from the toolbar. At least one meter must be assigned to an **active** (On) channel. You can select to view up to 32 meters at a given time. (See page 82).
- PostView post-acq data viewer** The "PostView post acquisition data viewer" selection accesses the *PostView* program. This independent program allows you to view waveforms recorded by data acquisition programs such as *ChartView*, *ChartView Plus*, and *TempView*. PostView is detailed in chapter *PostView* on page 141.

Device Interface

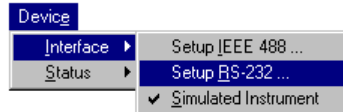

Setup IEEE 488

The IEEE 488 Setup dialog box appears. Valid addresses are 0 to 30. DIP switch settings must agree with this setup. Note that a PC/IEEE 488 interface card is required for use of the TempScan/1100's or MultiScan/1200's IEEE 488 interface.

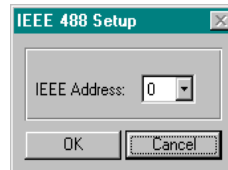

Setup RS-232

The RS-232 Setup dialog box appears. If "Yes" is chosen for modem, the RS-232 Setup window changes, allowing you to cancel your *call waiting* service by entering your cancellation code and your modem phone number. The Cancel Code pull-down list provides three common codes from which you can make a selection, or you can simply type in the applicable code. Note that DIP switch settings must match.

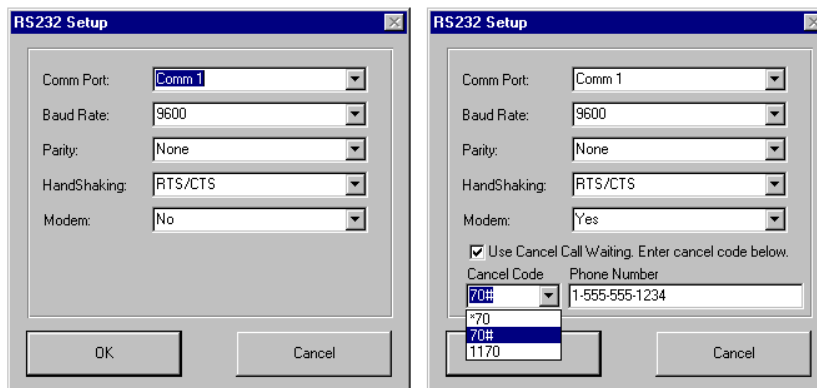

Comm Port	1-16
Baud Rate	300, 600, 1200, 2400, 4800, or 9600
Parity	None, Odd, or Even
Handshaking	None or RTS/CTS
Modem	No or Yes
Cancel Codes for Call Waiting	*70, 70#, 1170, or type in other acceptable code

Note: Use the appropriate code for the phone system in your area.

Simulated Instrument

The program will generate data from a simulated instrument with no actual hardware concerns.

Device Status

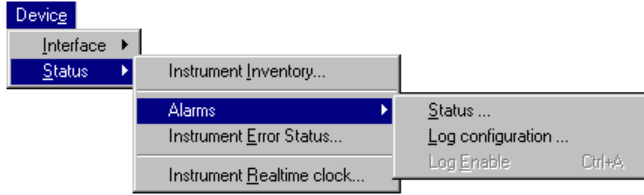

Instrument Inventory

Accesses the System Inventory dialog box.

Alarms

Brings up selection list for Status, Log configuration, and Log Enable

Status

Brings up the Alarm Status box. The Alarm Status box shows the current state of each alarm. The alarm state appears as either a "1" or "0", the "1" being digital High, and the "0" being digital Low (0). A one-for-one correlation between the alarm number and channel can only occur if each channel of a 32 channel [or less] system is assigned to a dedicated alarm number.

Log configuration

Alarm logging is a feature of *ChartView Plus* only. Alarm Logging allows you to monitor the Alarm states of the instrument, and save selected information to a file whenever any of the states change. Alarm logging is implemented by periodically polling the instrument; the time interval between polls is about one second. With this in mind you should note that any event that could trigger an alarm, that is one second or less in duration, could be missed and not logged.

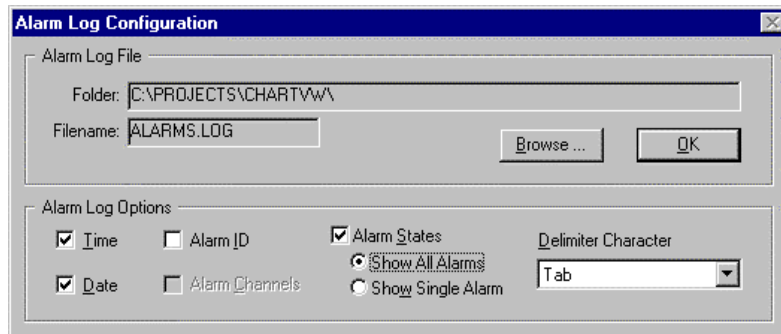

From the Alarm configuration dialog box you can define the information that will be saved in the log file. Options include the Time and Date when the state change occurred, the Alarm number, the Channel(s) that tripped the alarm along with the current reading, and the state of the alarm itself or all alarms, either 1 or 0. Additionally you can define the character that is used to separate the information in the file. This is useful if you want to read the file into a program that presents the information in a tabular format, such as Microsoft Excel.

By using combinations of option settings you can define how the alarm log file is filled. If you choose not to save Alarm ID's (Alarm numbers) in combination with saving All Alarm States, your Alarm file will be saved with one line of text each time an Alarm state change is detected during polling. The line will contain the optional Time and Date and 32 digits, one for each alarm, set to either 0 or 1. The left most digit being Alarm one, the rightmost Alarm 32. Note that you can not choose to save Channel information if you have selected not to save Alarm ID's. The following example shows what the Alarm log entries look like if this configuration is selected:

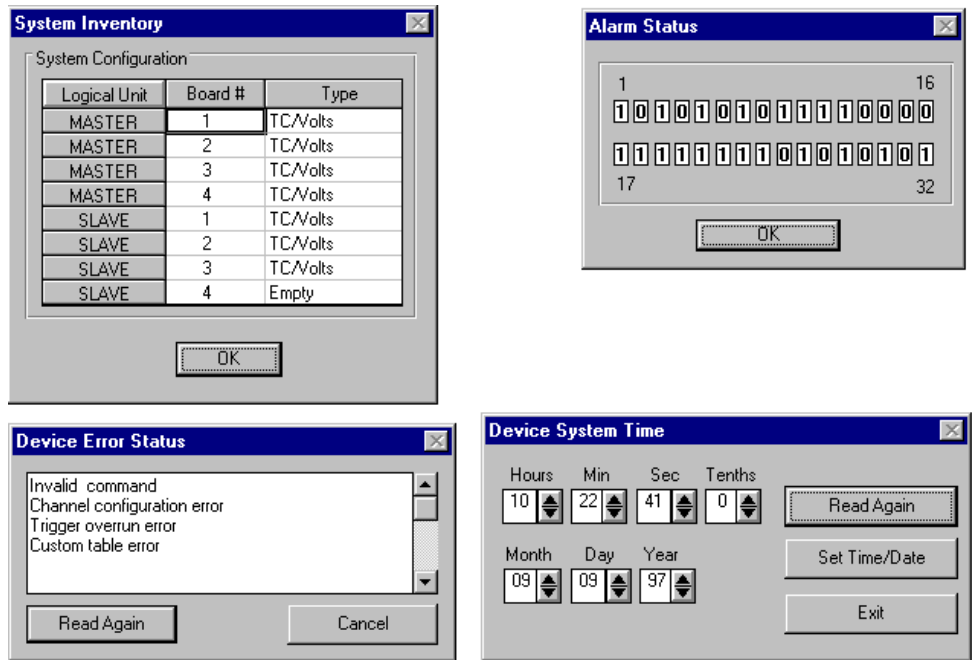

Device Status Dialog Boxes

Device Configuration

A Device Expanded Menu (obtained with use of the F12 Key)

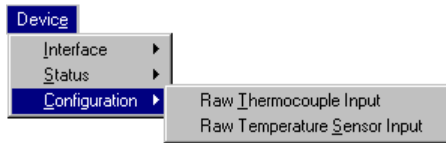

You can expand the Device pull-down menu by pressing the F12 function key on your computer keyboard prior to pulling down the menu. After pressing F12 the pull-down menu will show a listing entitled "Configuration." The expanded-menu setting is not saved in the configuration file when exiting *ChartView*. If the expanded menu is desired you must press F12 each time you start *ChartView*. This expanded menu is typically not used by the operator. The *Raw Thermocouple Input* and *Raw Temperature Sensor Input* selections primarily exist as an aid in troubleshooting by experienced technicians.

Setup Menu



Channels & Alarms **Ctrl+L**

Accesses the Setup Window for configuring channels and alarms. From the channels & alarms dialog box you can select the Acquisition Setup and Data Destination dialog boxes.

Acquisition **Ctrl+C**

Accesses the Acquisition Setup dialog box. From the Acquisition Setup box you can select the Channels & Alarms dialog box, as well as the Data Destination dialog box.

Data Destination

Accesses the Setup Window for assigning the Data Destination and also provides a means of configuring the Auto Re-arm feature for *ChartView Plus* (see page 91). From the Data Destination dialog box you can directly access the Acquisition Setup and the Channels & Alarms dialog boxes.

Bar Graph, Analog & Digital Meters

Overview

This section pertains to channel data display screens (windows, or dialog boxes) other than the main chart screen (*ChartView*'s main window).

After a brief discussion and illustration of each meter type, commonalities to these three types of meters is presented. These common areas include: Toolbars, Pull-Down Menus, and two special Pop-Up Menus, one for configuring the meters, and the other for replacing a represented channel with another.

Note: The acquisition-to-disk has a higher priority than the updating of Charts, Meters, and the Reading column. Therefore, data is displayed as soon as the acquisition task is satisfied. As the scan rate is increased, the acquisition-to-disk task will take up more processor (CPU) time and the displaying of data will be updated as time allows. If you select linear conversion ($mX + b$) as the units for channel configuration you should expect a further impact on real time display performance. The $mX + b$ conversion is discussed in the section, *Channel and Alarm Setup Dialog Box*.

Note: The meter channels selected are independent of the group chart assignments.

Bar Graph Meters

Selecting Bar Graph Meters from *ChartView*'s **Window** pull-down menu brings up the Bar Graph window. This window displays several channels in bar graph format. To activate the display, select the Start button from the toolbar. At least one meter must be assigned to an **active** (On) channel. You can select to view up to 32 meters at a given time.

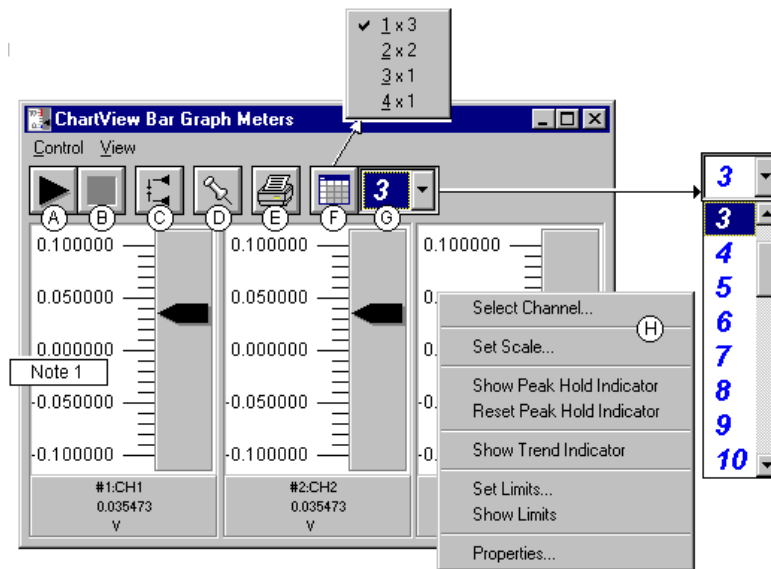

Bar Graph Meters, Shown with 3 Meters Selected for Viewing

Note: Double-clicking the left mouse button in a meters scale area brings up a channel selection pop-up menu. A single click with the right mouse button in this same area brings up a configuration pop-up menu (item H). Both of these pop-up menus are discussed in the section, *Meters Configuration Menu*.

The items in this window are as follows:

- | | | | |
|-----------|---------------------|--------------------|-------------------------------|
| A - Start | C - Reset Peak Hold | E - Print | G - Number of Meters |
| B - Stop | D - Stay On Top | F - Rows x Columns | H - Configuration Pop-Up Menu |

These items are discussed in more detail, following the description of Digital Meters.

Configuration Note:**. for Bar Graph Meters**

For Bar Graph Meters, configure the meter settings by first clicking the right mouse button anywhere within the meter display area. A pop-up menu will appear allowing you to reconfigure the meter in regard to scale, limits, channel selection, adding peak hold indicators, etc. Refer to the section entitled *Meters Configuration Menu* for more detail.

Analog Meters

Selecting Analog Meters from *ChartView's* Window pull-down menu brings up the Analog Meters window. This window displays several channels in a dial/gage format. To activate the display, select the Start button from the toolbar. At least one meter must be assigned to an **active** (On) channel. You can select to view up to 32 meters at a given time.

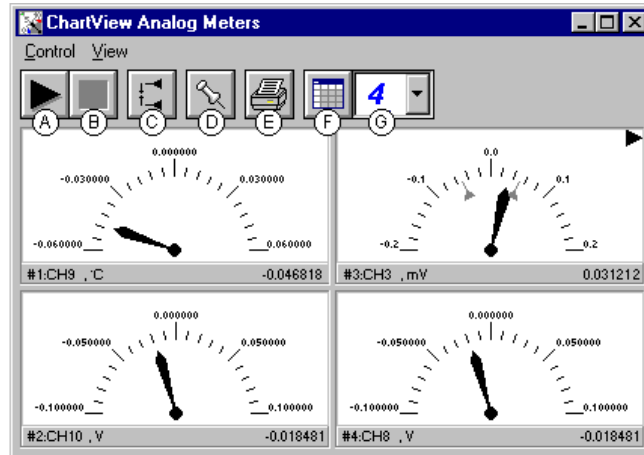

Analog Meters, Shown with 4 Meters Selected for Viewing

Double-clicking the left mouse button in a meters scale area brings up a channel selection pop-up menu (not shown). A single-click with the right mouse button in this same area brings up a configuration pop-up menu (see Bar Graph Meters figure, item H). Both of these pop-up menus are discussed in the section, *Meters Configuration Menu*.

Note that Meter #3 (CH3) in the above figure shows Peak Indicators near the pointer, as well as a trend indicator in the upper right hand corner of the meter.

The items in this window are as follows:

- | | | | |
|-----------|---------------------|--------------------|-------------------------------|
| A - Start | C - Reset Peak Hold | E - Print | G - Number of Meters |
| B - Stop | D - Stay On Top | F - Rows x Columns | H - Configuration Pop-Up Menu |

These items are discussed in more detail, following the description of the Digital Meters.

Configuration Note:**. for Analog Meters**

For Analog Meters, configure the meter settings by first clicking the right mouse button anywhere within the meter display area. A pop-up menu will appear allowing you to reconfigure the meter in regard to scale, limits, channel selection, adding peak hold indicators, etc. Refer to the section entitled *Meters Configuration Menu* for more detail.

Digital Meters

Selecting Digital Meters from *ChartView's* **Window** pull-down menu brings up the Digital Meters window to display several channels in numeric format. To activate the display, select the Start button from the toolbar. At least one meter must be assigned to an **active** (On) channel. You can select to view up to 32 meters at a given time.

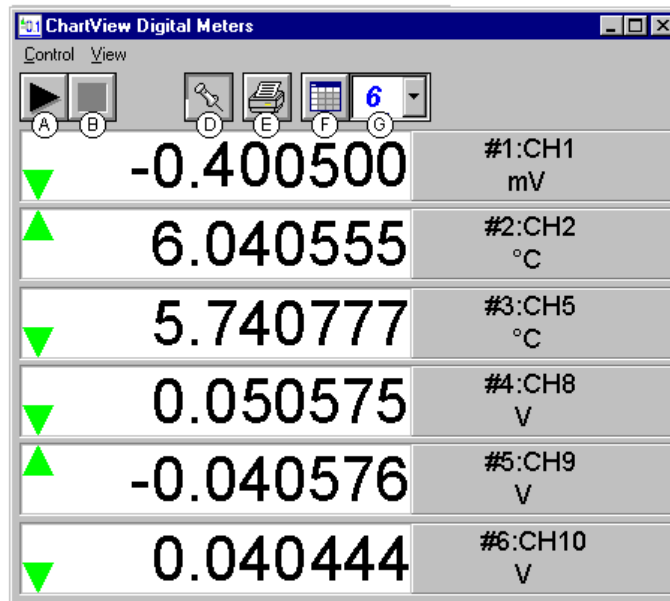

Digital Meters, Shown with 6 Meters Selected for Viewing

Note: Although the Digital Meters instrument is capable of displaying 6 decimal places, there is not 6 place accuracy in the readings. Due to transducer and transient noises, the accuracy of voltage readings is $\pm 0.02\%$. Temperature accuracy varies, depending on thermocouple type; with type J 0.5°C for a range of -100°C to +760°C. For your application, please refer to specifications of the signal conditioning card(s) used, as well as the thermocouple type, and the data acquisition instrument used (TempScan/1100 or MultiScan/1200).

Double-clicking the left mouse button in a meters scale area brings up a channel selection pop-up menu (not shown). A single-click with the right mouse button in this same area brings up a configuration pop-up menu (see Bar Graph Meters figure, item H). Both of these pop-up menus are discussed in the section, *Meters Configuration Menu*. Note that each of the above channels shows a trend indicator on the left side of the meter.

The items in this window are as follows:

- | | | | |
|-----------|-----------------|--------------------|-------------------------------|
| A - Start | C - N/A | E - Print | G - Number of Meters |
| B - Stop | D - Stay On Top | F - Rows x Columns | H - Configuration Pop-Up Menu |

Toolbar items A through G are discussed in more detail in the following section, *Meter Toolbars*. Item H is discussed in the subsequent section, *Meters Configuration Menu*.

Configuration Note:

. For Digital Meters

Configure the Digital Meters settings by first clicking the right mouse button anywhere within the digital meter display area. A pop-up menu will appear allowing you to reconfigure the meter in regard to scale, limits, channel selection, etc. Refer to the section entitled *Configure Meter Settings* for more detail.

Meters Toolbars

The toolbars for the three meter types are identical, with exception that the Digital Meters toolbar does not have a **Reset Peak Hold button** (item C in the following figure).



Meters Toolbar Buttons

Item	Name	Function
A	Start	Starts meters.
B	Stop	Stops meters.
C	Reset Peak Hold Indicator	Resets the floating markers. Upon reset, the markers will instantly adjust to indicate the highest and lowest values reached since the time of the reset. This feature does not apply to the Digital Meters.
D	Stay On Top (Push pin)	Locks or unlocks the meter window on top of other windows.
E	Print	Sends the meter(s) display image to connected printer.
F	Rows x Columns	Opens a small menu with “row x column” arrangement options. <i>Example:</i> When the number of meters is 6 the grid options will be: <u>6</u> x1, <u>3</u> x2, <u>2</u> x3, and <u>2</u> x4 with the first number being the number of rows. If you then select <u>3</u> x2 you will have 3 rows of meters with 2 meters per row.
G	Number of Meters	Specifies the number of meters to appear on the screen. A maximum number of 32 meters can be selected.

Meters Pull-Down Menus

The meters windows each have a Control and View pull-down menu, as indicated by the following figure. The functions of these menus can also be implemented by using the toolbar buttons.

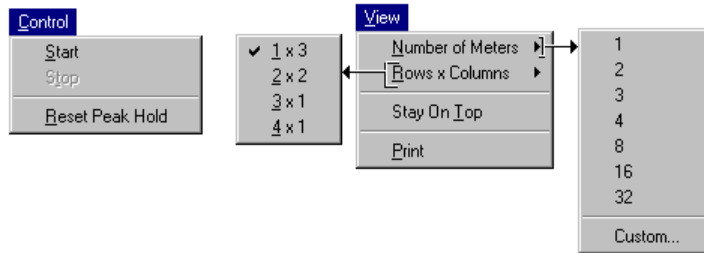

Meters Configuration Menu

A meters configuration menu (lower left corner of figure) will appear when you place the mouse pointer over a meter and click the right-hand mouse button. The menu allows you to access various dialog boxes for changing parameters for an individual meter, or simultaneously for a group of meters. The steps for configuring a meter are detailed below.

Note: The *Show Peak Hold Indicator / Reset Peak Hold Indicator* selections are not an option for Digital Meters and do not appear on the configuration window for digital meters.

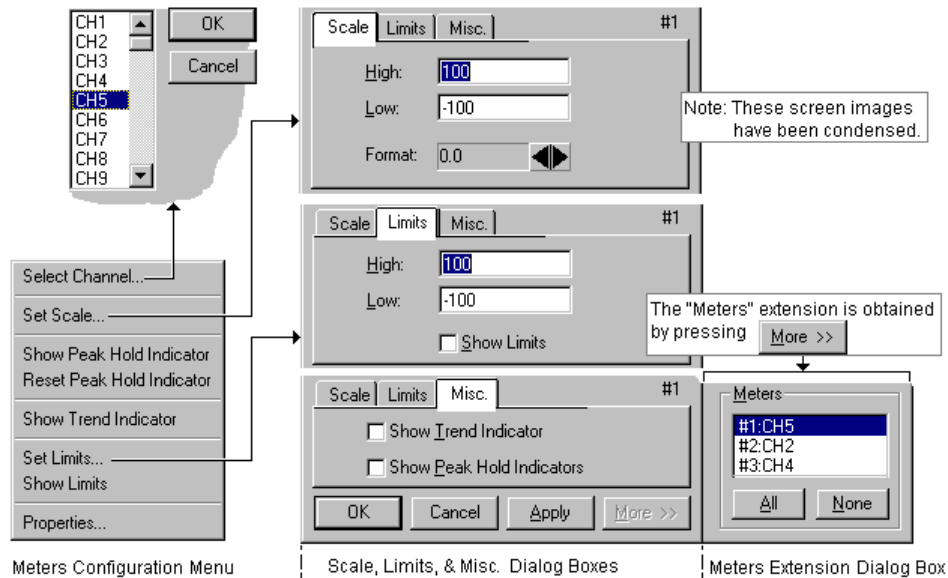

Meter Configuration Menu and Related Dialog Boxes

Configuring a Meter

1. Bring up the desired meter group (Bar Graph, Analog, or Digital).
2. Place the mouse cursor over the meter which you desire to reconfigure.
3. Click on the right mouse button. A Meters Configuration Menu, similar to that in the above figure, will appear.

Note: The *Show Peak Hold Indicator / Reset Peak Hold Indicator* selections are not an option for Digital Meters and do not appear on the configuration window for digital meters.

4. Select the desired option from the meter configuration menu.
5. If a dialog box is required, for example, to change a limit, simply enter in the new value in the appropriate parameter box and press "Apply" or "OK." Pressing "Apply" implements your changes, but keeps the dialog box open, allowing you to make additional changes. Pressing "OK" implements your changes and closes the dialog box.

The following table, as well as the preceding figure, serve as a quick reference to meters configuration.

Configure Meter Settings, Function Descriptions

	<u>Function</u>	<u>Description</u>
1	Select Channel	Select a new channel for display. The selected channel will replace the one currently seen in the meter. Note that double-clicking the left mouse button in the meter region will also bring up a dialog box which allows you to select a new channel.
2	Set Scale	Set the high and low points of the scale, as well as define the decimal place format.
3	Show Peak Hold Indicator	Places high and low uni-directional floating markers on the scale to indicate the highest and lowest values reached up to the present time. This feature does not apply to the Digital Meters selection.
	Reset Peak Hold Indicator	Resets the floating markers. Upon reset, the markers will instantly adjust to indicate the highest and lowest values reached since the time of the reset. This feature does not apply to the Digital Meters selection.
4	Show Trend Indicator	Displays a pointer to indicate the direction of the trend. Note that during rapid meter fluctuations the increase and decrease pointers will appear to blink simultaneously.
5	Set Limits	Provides a way of establishing high and low limit set-points.
	Show Limits	Displays limits by adding color (red for high, blue for low) to the scale regions which equal and exceed the set limit values. For Digital Meters the limits are indicated by red numbers and an upper red bar for hitting or exceeding the high limit; and blue numbers and a lower blue bar when reaching or exceeding the low limit.
6	Properties	Allows setting and showing limits, as well as opening the Scale dialog box.

You can access a different dialog box from the one initially selected. For example, from the Set Scale dialog box you can select Limits to access the Set Limits/Show Limits display, as well as select “Misc.” Trend Indicator” and “Show Peak Hold Indicators.” You can use the Simulated Instrument mode to familiarize yourself with various meter configuration options.

Setup Window

The Setup Window is used to configure channels, setup acquisition parameters, and assign data destinations, and configure the auto re-arm feature. The Setup Window contains three tabs: *Channel and Alarm Setup*, *Acquisition Setup*, and *Data Destination*. Once in the Setup window you can access an inactive dialog box by clicking on its related tab. The three tabs remain visible, regardless of which dialog box is currently active.

Access the Setup window using one of the following methods:

- Use the Setup pull-down menu (on *ChartView s* main window) and select the desired dialog box (*Channel and Alarm Setup*, *Acquisition Setup*, or *Data Destination*)
- Double-click the Channel Configuration button (item 8, main window figure), then click on the appropriate dialog box tab

Channel & Alarm Setup Dialog Box

The Channel and Alarm Setup dialog box consists primarily of a configuration spread-sheet. The dialog box allows you to configure the input channels, and displays them. Each row shows a single channel and its configuration. The number of rows may vary (depending on the number of channels present in your acquisition system). Four of the columns (**On**, **Type**, **Label**, and **Units**) allow blocks of cells to be selected and altered at the same time. Clicking on one of these column headers selects the entire column.

When a cell is selected the message box reveals a note, and often a related pull-down list. In the following figure, the cell for channel “Type” has been selected. This caused the “CHOOSE TYPE->” message to appear, along with the type pull-down menu. Depending on the column, you can make changes to the information contained in the cell by either of the following methods:

- Double clicking the cell with the mouse
- Highlighting the cell and typing in the new value or label
- Selecting from a list
- Using copy (*Ctrl+C*) and paste (*Ctrl+V*) functions

The following table indicates message and pull-down menu aspects of the Channel and Alarm Setup Dialog Box.

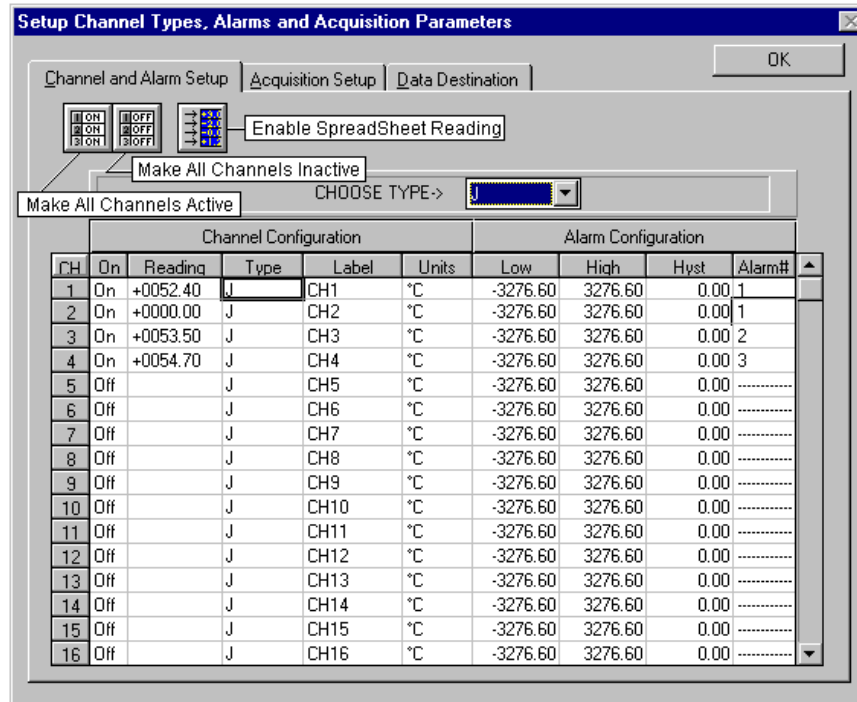

Channel and Alarm Setup Dialog Box Message and Pull-Down List Aspects			
Column	Message		List*
1	CH	N/A	---
2	On	ENABLE or DISABLE	✓
3	Reading	N/A	---
4	Type	CHOOSE TYPE->	✓
5	Label	ENTER LABEL (MAX = 8 LETTER)	---
6	Units	CHOOSE UNITS->	✓
7	Low	ENTER DESIRED LOW LIMIT	---
8	High	ENTER DESIRED HIGH LIMIT	---
9	Hyst	ENTER DESIRED HYSTERESIS	---
10	Alarm#	SELECT AN ALARM#	✓
*A "✓" indicates the associated item has a pull-down list from which a selection can be made.			

The pull-down list selection or copy/paste process are useful for making multiple channel configuration changes within a column. You may double-click within a cell to make your way through all the possible selections. The selections are repetitive; in other words, you will eventually advance to the same selection you started with.

The following text provides more detail regarding the channel and alarm configuration parameters. The number preceding the text refers to the column number with "1" being the left-hand column and "10" being the right-hand column of the Channel and Alarm Setup Dialog Box.

Channel Configuration Columns

1. **Channel (CH)**— This column serves *only* as a channel number indicator. The channel number *cannot* be changed from this column.
2. **On**— The On column allows you to enable a channel for data collection. When a cell or block of cells in this column is selected, a selection box will appear that allows “On” to enable or “Off” to disable the channel. Double-clicking a cell in this column toggles the channel’s enable status. Clicking the *Make All Channels Active* button enables (turns all channels “on”). Clicking on the *Make All Channels Inactive* button disables all channels (turns them “off”), with the exception that channels assigned to charts can only be turned off from the display configuration setup.
3. **Readings**— The reading column displays the scanning device input readings. The column is activated when you select the *Enable SpreadSheet Reading* button. The column’s values are *real-time* channel values from the instrument and cannot be altered by the user. This column will update the readings as fast as the computer will allow.

Note: Other areas of the SpreadSheet cannot be altered while the channel Readings column is enabled.
4. **Type**— A block of cells in this column can be selected for convenience of single type selection. Double-clicking a cell will select the next available type.
5. **Label**— The Label column identifies the input channel by descriptive name. The label is used when selecting a channel in the trigger and chart selection lists. The label column automatically uses the channel number as a default. You can change the label to any alpha-numeric designation not exceeding eight characters. Each label used must be unique (specific) to its designated channel.
6. **Units**— Cells in the Units column are dependent on the Type selected and automatically change when the type is changed, for example temperature units will be replaced by volts units when changing from a thermocouple type to a volts type.

If the channel is configured for Temperature the units automatically change to °C (default); at this point, you have the option of selecting a different engineering temperature unit (°F, °K, °R). **Note that the $mX+b$ equation, discussed in the following text, is typically not used for temperature readings, since temperature data will be linear.** However, you can use the equation in temperature applications, for example: setting **b** to **-32** in order to watch deviations from freezing point when temperature is in °F.

In addition, with *ChartView Plus* you can subtract a reference channel from the $mX+b$ equation to obtain a temperature differential, as indicated in the following example.

Example:

A heated room has 2 thermocouples (T1 for CH1 and T2 for CH2); with T1 being in the center of the room and T2 positioned at an outer wall. If the outer wall is monitored to ensure a temperature within $\pm 2^\circ\text{F}$ (of the temperature indicated by thermocouple T1), then CH1 can be used as a reference channel such that its value will be subtracted from the actual value for channel 2. Assume the central thermocouple is reading 90.5°F and the outer thermocouple (for CH2) is reading 89.0°F . In this case we can use the equation so channel 2’s charted reading will not be of the actual temperature, but will be the differential between CH1 and CH2, e.g.:

$y = (mX + b) - \text{ref. chan.}$; where:
 y = Channel 2’s charted value (a temperature differential)
 $m = 1$
 $b = 0$
 $X = \text{CH2}$
 $\text{ref. Chan.} = \text{CH1}$
 Channel 2’s charted value = $(1 \times \text{CH2} + 0) - \text{CH1}$
 Channel 2’s charted value = $(1 \times 89.0^\circ\text{F} + 0) - 90.5^\circ\text{F}$
Channel 2s charted value = -1.5°F

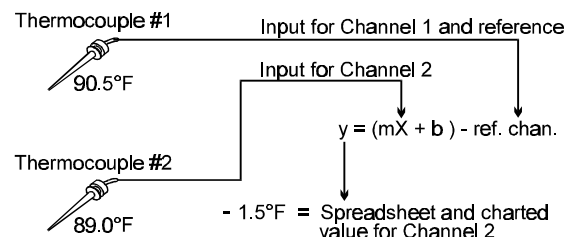

Note: The reference channel feature is only available with *ChartView Plus*.

Note: When using a channel as a reference channel, remember that lower numbered channels are calculated ahead of higher numbered channels, e.g., CH1 is calculated ahead of CH2. This makes a difference when subtracting a reference channel in regard to the time aspect of the reference value.

If the channel is configured for Volts, the units automatically change to V; at this point you have the option of selecting the millivolt unit (mV). The user can also change each channel to apply a linear equation ($mX+b$) to the data. When the $mX+b$ option is selected the Configure Engineering Units dialog box is displayed. You are prompted to define “ m ” and “ b ” and the engineering units label; as well as which standard units the $mX+b$ equation should be applied to. The engineering units chosen will be displayed in the “Units” column, and the “ $mX+b$ ” equation will be applied to the reading from the device before the reading is displayed or written to disk.

The $mX+b$ option is convenient for obtaining a value which has a linear relation to a channel reading.

X is the scanned voltage value read back from the acquisition device

m is [but not limited to] a *proportionality constant* or *gain factor*, but not zero.

b is the *offset value* (the value of the calculated reading when the scanned value is “zero”).

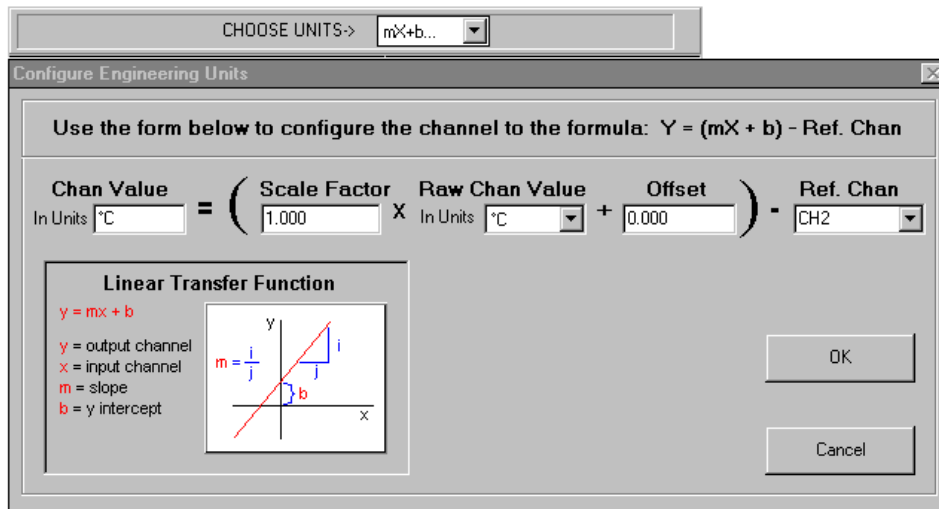

Alarm Configuration Columns

1. **Low Limit** — Set alarm low limit.
2. **High Limit** — Set alarm high limit.
3. **Hysteresis** — A hysteresis value can be set for each channel to avoid a “chatter” problem.
4. **Alarm #** — You can assign one alarm number (1 to 32) to a channel. Any number of channels can be assigned to the same alarm number. A given digital output will be set “true” (1) if at least one of the common channels (assigned to a single alarm) enters an alarm state.

Acquisition Setup Dialog Box

The information entered in the Acquisition Setup dialog box is used by the Arm Acquisition command to set up the acquisition of data to disk. When the trigger is satisfied, the scans are collected at the selected scan frequency and stored to disk in the designated file.

The Acquisition Setup dialog box can be accessed in one of three ways: a) clicking on the Channel Configuration button (item 8 in Main Window figure), b) clicking on the Acquisition Setup tab from the Channels or Data Destination dialog boxes, c) using the Setup pull-down menu and selecting *Acquisition*.

The MultiScan/1200 has two modes of data acquisition, these are:

- Normal mode
- High-speed, single-channel mode (burst mode)

The mode is selected from the lower left-hand portion of the dialog box. The following figure represents a screen capture with normal mode selected.

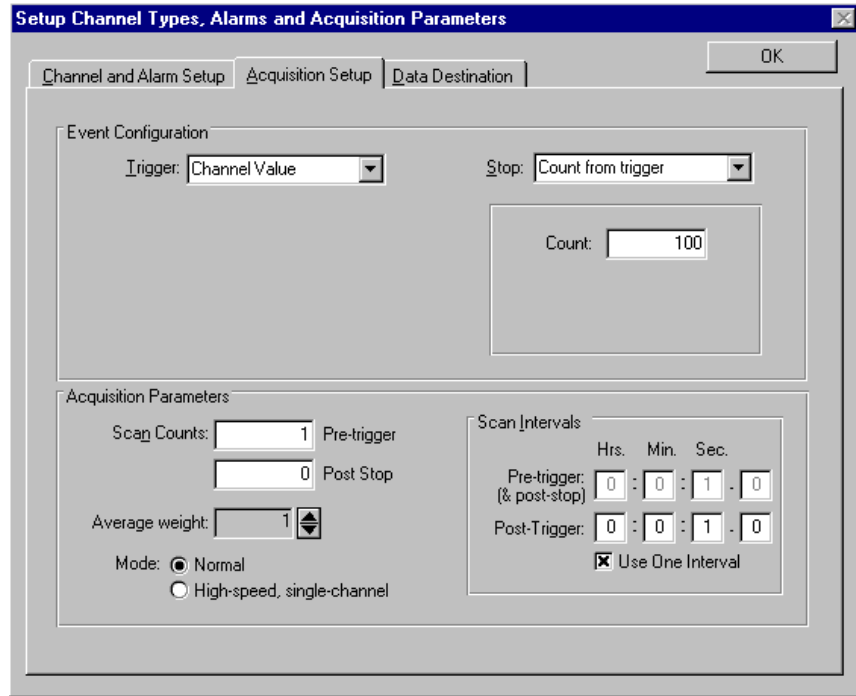

Acquisition Setup Dialog Box, Normal Mode

The following figure depicts the parts that make up an acquisition. The Trigger and Stop Points represent the entries described under the Event Configuration selection in the table on the following page.

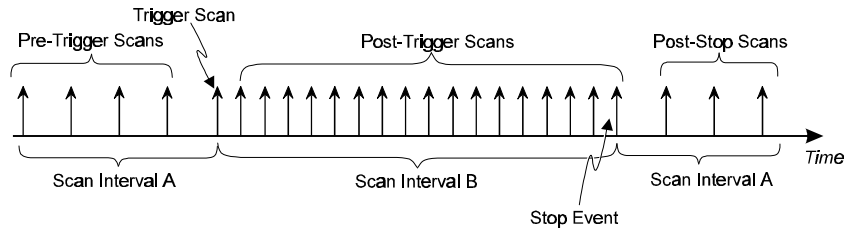

Acquisition Example

In the “**High-speed, single-channel**” mode the *Scan Intervals* parameters section is replaced with a *High-Speed Setup* parameters section with boxes for selection of *Channel* and *Scan Rate*, as indicated in the following figure.

Note: In the High-speed, single-channel (burst mode) all *ChartView* display functions are intentionally disabled. Data acquisition and storage to disk are the only services which remain functional. When you select the High-speed, single channel mode, a Warning dialog box appears with this information, providing you with the opportunity to cancel if desired.

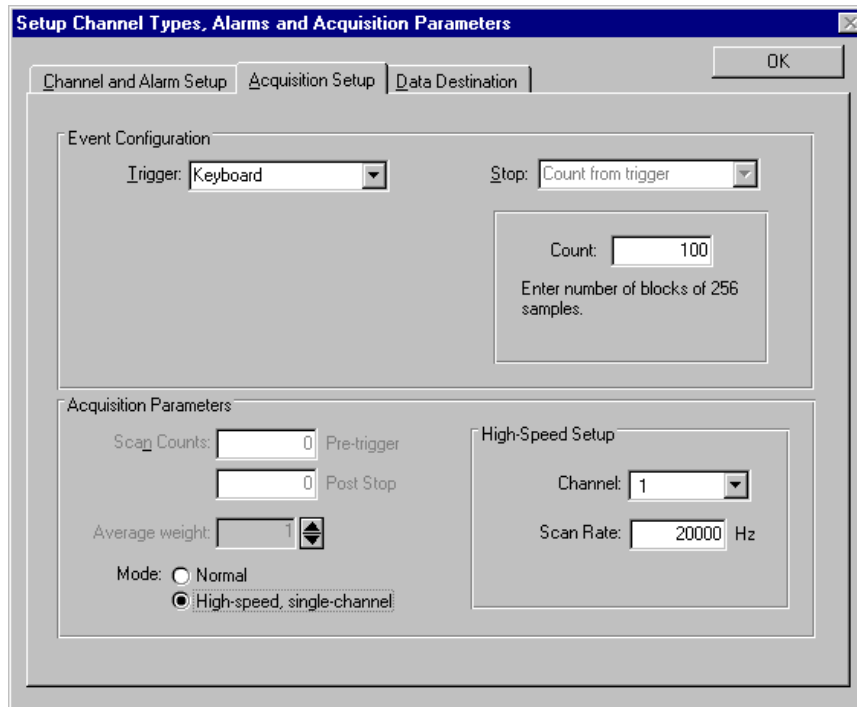

Acquisition Setup Dialog Box, High-Speed, Single-Channel Mode

Acquisition Setup	
Parameter	Options
Event Configuration	<p>Trigger: Set a trigger scan in the Acquisition by using one of the following: Keyboard - Use Console Trigger dialog box to start trigger scan. <i>Note: If the Keyboard Trigger is selected the use of Pre-trigger is disabled.</i> External TTL - Use an external signal to start the trigger scan. Channel Value - Use specified value of a given channel. Alarm - Use an Alarm value to start the trigger scan. Absolute Time - Use a time of day to start the trigger scan. <i>Note: If Absolute Time is selected, the use of Auto Re-arm is disabled.</i></p> <p>Stop: Set a stop scan in the Acquisition by using one of the above selections or Count (as specified below). Keyboard isn't applicable. If a MultiScan/1200 is connected and High-Speed Single-Channel (Burst Mode) is selected, then "Count from trigger" is the only Stop available for the event configuration.</p> <p>Count: Specify a number of scans to be read before a stop scan is set.</p>
Acquisition Parameters	<p>Scan Counts: Specify the number of scans in an acquisition Pre-trigger Post Stop</p> <p>Average weight: Average weight can be specified only when in the Normal Mode. The value for the average weight determines the number of samples to be averaged when in Normal Mode. Values of 1, 2, 4, and 8 are for high-speed multiple channel applications for thermocouples and DC voltages where noise filtering is not an issue. Values of 16, 32, 64, 128, and 256 are recommended for AC noise rejection.</p> <p>Scan Intervals: Time between scans (frequency of scans) Pre-trigger and Post Stop Post-trigger Use one Interval</p> <p>High Speed Setup: Allows for channel and scan rate entries for high-speed, single channel mode.</p>
Note: These parameters cannot be altered while an acquisition is in progress.	

Data Destination Dialog Box

Data Destination

The Data Destination portion of the box is used to assign a filename and folder location for data, select an Excel or binary format (.TXT or .IOT respectively), and to select optional Time/Date and/or Alarm Stamps (to be included in the data) if desired. The dialog box can be accessed from the *Channel and Alarm Setup* and *Acquisition Setup* dialog boxes by selecting the *Data Destination* tab, or by selecting *Data Destination* from the Setup pull-down menu. You can quickly access the *Channel and Alarm Setup* and *Acquisition Setup* dialog boxes by selecting the appropriate folder tab image located near the top of the Data Destination dialog box.

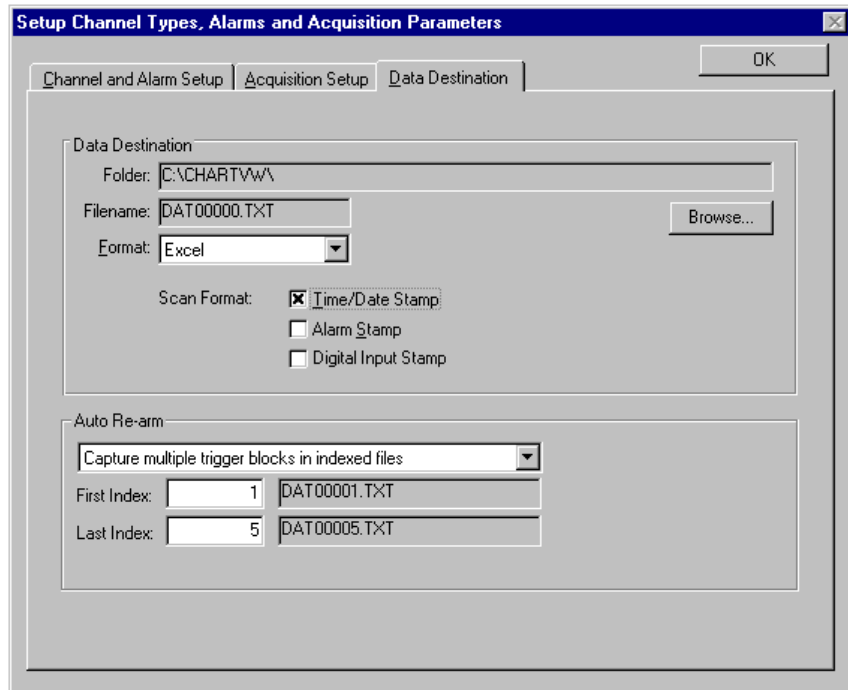

Destination Dialog Box

The following items describe key areas of the Data Destination box. Note that if you have *ChartView Plus*, you can use the lower section of the Data Destination box to configure Auto Re-arm as described in the sub-section below, entitled *Auto Re-arm (for ChartView Plus Only)*.

Folder: The drive and directory where data will be written to.
Filename: Name of data file.
Format: File saved as an Excel (.TXT) or Binary (.IOT) format.
Scan Format: Data marked with Time/Date Stamp and/or Alarm Stamp.

Note: These parameters cannot be altered while the acquisition is in progress.

Auto Re-arm (for ChartView Plus only)

Auto Re-arm is a feature available with *ChartView Plus*. As seen in the previous figure, *Auto Re-arm* is accessed from the Data Destination box. The *Auto Re-arm* feature allows for a large number of acquisitions to take place automatically, with each acquisition using the same configuration settings. With *Auto Re-arm*, the system immediately re-arms itself, waiting for the trigger to be satisfied, as soon as the previous trigger block is terminated.

Auto Re-arm allows you to choose one of the following three options:

- Capture one trigger block (default, *Auto Re-arm* disabled)
- Capture multiple trigger blocks in one file
- Capture multiple trigger blocks in indexed files

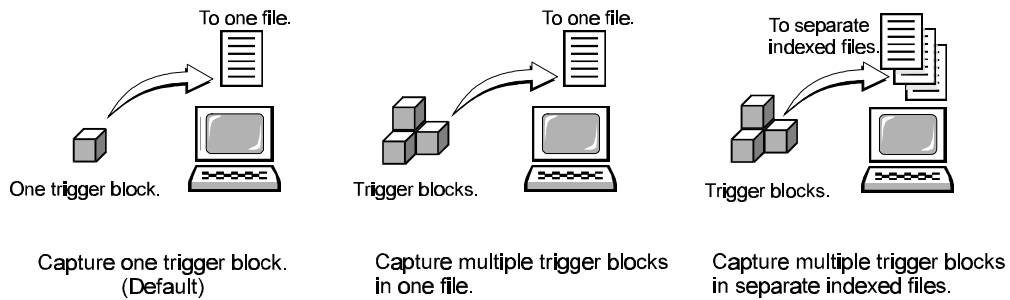

Auto Re-arm Options

Why use *Auto Re-arm*?

You can use *Auto Re-arm* as a convenient way to monitor and analyze specific types of trigger events. For example, if you set Channel 1 going above 30°C as a trigger, you can choose to repeat 100 (or more) acquisitions with this same trigger criteria (Channel 1 > 30°C). Whether you select to capture the trigger blocks in one file, or each in a separate file, each of the data acquisitions will occur automatically; and each will make use of your set configuration.

Disabling *Auto Re-arm*

To disable *Auto Re-arm*, simply use *Auto Re-arm*'s default setting of “Capture one trigger block.” When you capture only one trigger block you are, in essence, not making use of the automatic re-arm feature.

Note: The trigger event, trigger by *absolute time*, is not suitable for automatic re-arming. In this instance the default of “Capture one trigger block” is automatically forced.

Chart Setup Wizard

Introduction

Chart Setup Wizard is a feature of *ChartView*, *ChartView Plus* and *PostView*. The feature allows you to set up your initial chart display configuration using an automated method, or manually create a new display configuration. The following points are important in regard to the *Chart Setup Wizard*.

- You can edit the chart display by accessing the *Display Configuration Setup* dialog box from the Chart pull-down menu or by clicking of the Chart Setup button in the main window toolbar. This method does not use the *Chart Setup Wizard* and **does not reset your chart display configuration setup.**
- Activating the *Chart Setup Wizard* **will reset your chart Display Configuration Setup.** It will not reset your Channel and Alarm configuration.
- *Chart Setup Wizard*, as described in this text, covers the expanded setup applications available with *ChartView Plus*. The basic *ChartView* program does not permit overlapping channels or having more than 1 chart group.
- Expanded applications (*ChartView Plus*) can be activated by use of a special code available from the factory at an activation cost. Please consult your service representative for more detailed information.

Activating the *Chart Setup Wizard* from the Chart pull-down menu will result in the following dialog box, providing a warning that proceeding with the operation will reset your Display Setup.

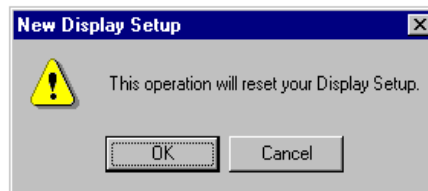

The *Chart Setup Wizard* window appears when you attempt to run *ChartView* for the very first time, as well as when a configuration file does not exist. When a configuration file already exists, you can easily access the *Chart Setup Wizard* by selecting Wizard in the Chart pull-down menu. It is important to realize that running the *Chart Setup Wizard* will result in a reset of your display setup; it will not, however, change your channel and alarm configuration (with the exception of new display channels now enabled).

The chart setup determines how your *ChartView Main Window* will appear in regard to the following:

- Number of chart groups available for viewing
- Number of charts shown for each selected group
- The number of overlapping channels in each chart (not to exceed 4)

You can choose to manually create a configuration, or have one created automatically. The automatic setup method offers three choices: Simple, Moderate, and Advanced. Moderate and advanced are only available with *ChartView Plus*.

Note: You can use *Chart Setup Wizard* to quickly set up a large number of charts. You can then fine-tune the layout manually via the *Manual Chart Creation* feature.

A *Manual Chart Creation, Create Charts* button allows you to bypass the *Chart Setup Wizard* and enter a manual mode. This option makes use of *ChartView's* Display Configuration feature (see page 63). Manual chart creation allows you to vary the number of assigned channels per chart, as well as vary the number of charts per group.



Chart Setup Wizard, Simple Mode

Chart Setup Wizard, Automatic Setup Options			
Setup Type	Group Setup (for Chart Groups)	Chart Setup	Channel Setup
Simple	1 group only	Up to 16 charts	1 channel per chart
Moderate ¹	1 group only	Up to 16 charts	Up to 4 overlapping channels per chart
Advanced ¹	Up to 64 groups	Up to 16 charts per group	Up to 4 overlapping channels per chart

Note¹: Moderate and Advanced modes of Automatic Chart Creation are only available with *ChartView Plus*. The standard *ChartView* program allows for 1 chart group only, and does not permit overlapping channels.

Note²: The *Manual Chart Creation, Create Charts* button (above figure) allows you to exit the *Chart Setup Wizard* and enter a manual create chart display mode.

Automatic Chart Creation with Wizard

The previous figure shows the Simple mode dialog box for Automatic Chart Creation. The following figures show the Moderate and Advanced mode dialog boxes (available only with *ChartView Plus*).

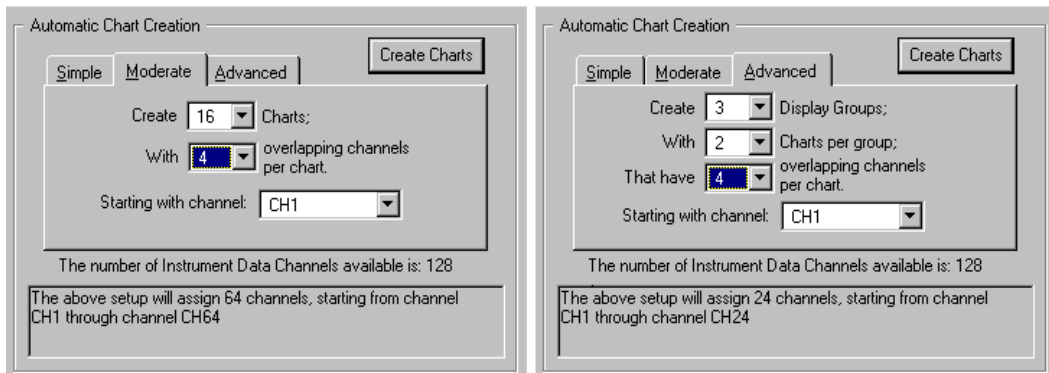

Dialog Boxes for Moderate and Advanced Modes of Automatic Chart Creation, ChartView Plus Only

It is a simple task to create chart display configurations using the automatic method. The following steps apply to this feature of *Chart Setup Wizard*.

1. Select Wizard from the Chart pull-down menu of *ChartView s* main window. The New Display Setup dialog box appears.

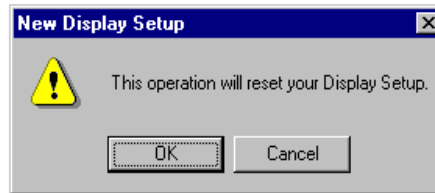

2. Click OK on the New Display Setup dialog box. The Wizard setup window appears.
3. Select the desired mode tab (Simple, Moderate, or Advanced). Moderate and advanced modes are only available with *ChartView Plus*.
4. Use the pull-down arrows (▼), or use the cursor and type in a new value to make selections for the number of groups, charts, and channels as applicable.
5. If you desire to start with a channel other than channel 1, use the pull-down arrow and select the desired starting channel number.
6. When your setup is complete, click on the *Automatic Chart Creation, Create Charts* button. A percentage of completion bar will appear, followed by the Channel and Alarm Setup box.
7. Make appropriate configuration changes, if any are desired, including enabling additional channels; then click on the OK button. After clicking OK, the Main Window appears and you can begin running charts. Note that the *Channel and Alarm Setup* section of this chapter contains related information.

The channels in the setup you create will be automatically enabled and will appear in chart form on *ChartView s* Main Window. The Channels will overlap on their assigned Chart (for *ChartView Plus* applications), and will be visible when the applicable Group is selected. Note that only one group of charts can be viewed at a time.

As mentioned earlier, you can enable additional channels from the Channel and Alarm Setup window. Enabling additional channels allows you to acquire more data to disk; however, it will not change your display on *ChartView s* Main Window. In other words, you can acquire data from channels which you do not monitor.

Bypassing Automatic Chart Creation

You can bypass *Chart Setup Wizard* by clicking on the *Manual Chart Creation, Create Charts* button in *Chart Setup Wizard s* main window. After selecting this option you will be using the Display Configuration Setup dialog boxes to create a display from scratch, i.e., using a “clean slate” approach. This method is detailed with an example, in the section *Manually Creating a Display*, beginning on page 66.



Notes

Introduction	97	Device Menu Items.....122
Default Configuration File.....	97	Device Menu Items (Expanded).....125
TempView Installation, Startup & Setup	98	Alarms Menu Items.....127
TempView Main Window	102	TempView Charts & Meters Windows
Channel Configuration Area.....	103	129
Status Area.....	107	Channel Display Area.....132
System State Area.....	107	Control Menu Items (Charts & Meters).....133
File Menu Items.....	108	Speed Menu Items (Charts Only).....134
Edit Menu Items.....	110	Options Menu Items (Charts Only).....135
Acquire Menu Items.....	111	View Menu Items (Meters Only).....136
Data Menu Items.....	117	Configure Meter Pop-Up Menu Items (Meters Only).....137
Window Menu Items	121	

Introduction

Because this chapter contains a great deal of information, you should glance through it to get an idea of its contents and layout. Some sections are intended for first-time users, while other sections are for more-experienced users.

TempView is a graphic Windows-based data acquisition application which can be used for either TempScan/1100 or MultiScan/1200 system applications. This application replaces the earlier TempWindows and MultiView applications formerly used with older TempScan/1100 and MultiScan/1200 models, respectively. TempView was designed for ease-of-use with no need for programming and configuration expertise.

TempView provides you with the capability to:

- Set up analog input parameters to acquire data.
- Configure alarms and acquisitions.
- View real-time displays of channel data via the Main Window Grid, Chart recorder functions, and Meters indicators.
- Save data to disk and transmit data to Microsoft Excel.
- Start PostView, an independent application that allows you to graphically view waveforms for up to 16 data channels.
- Use remote RS-232 communications; simply by attaching the acquisition device to a modem configured for Auto Answer.

Default Configuration File

As its default, TempView will use the **TEMPVIEW.CFG** file to provide initialization information. The *.CFG configuration file maintains a location for TempView configuration information including:

- *Device Interface*
- *Channel Configuration*
- *Acquisition Parameters*
- *Data File Parameters*

The configuration file ensures that when you restart TempView, it will be in the same state upon your last exit. This means that the **TEMPVIEW.CFG** file will be an updated copy of the configuration file you are using at the time you exit TempView. The **TEMPVIEW.CFG** file is user-transparent and is generated, and automatically saved, upon exiting TempView. TempView will use the **TEMPVIEW.CFG** file to assist during its next default starting.

It is not catastrophic if this file is deleted since it is a simple task to start TempView when no **TEMPVIEW.CFG** file exists. Otherwise, you can direct TempView to use a different ***.CFG** file by manually selecting another available file.

TempView Installation, Startup & Setup

To Install TempView in Windows 3.X or Windows 95

1. Make a back-up copy of the TempScan/1100 or MultiScan/1200 Release Disks.
2. Make sure that your PC fulfills the following computer requirements for successful software installation:
 - Windows 3.X or Windows 95
 - For Windows 3.X, a computer system with at least a 3x86 processor, and at least 8 MB of RAM is recommended for overall satisfactory performance.
 - For Windows 95, a computer system with at least a 4x86 processor, and at least 16 MB of RAM is recommended for overall satisfactory performance.
3. If your PC does not fulfill the above requirements, perform the necessary hardware upgrades, or select another PC for software installation.

If your PC fulfills the requirements, continue to Step 4.

4. Boot up your PC according to the manufacturer's instructions.
5. If necessary, remove any previous installation of ChartView or TempView, before installing this new version. The recommended method of uninstallation is to navigate to the Windows *Control Panel*, then double-click the *Add/Remove Programs* icon and follow the instructions.
6. Place the TempScan/1100 or MultiScan/1200 Back-Up Release Disk 1 into the floppy drive from which you are installing (typically drive **A:**).
7. Run the **A:\SETUP.EXE** program, or double-click its icon.
8. Follow the directions in the on-screen dialog boxes.
9. When you have successfully completed the software installation, you can navigate to the new *TempView* program group, and check that all of the programs are present.

To Start Up TempView

1. From Windows 3.X or Windows 95, open TempView using one of the following methods:

For first-time users of TempView. Double-click on the TempView icon, or select the TempView option from the TempView program group. The *TempView Startup* dialog box appears. Continue to Step 2.



TempView Startup Dialog Box

For more-familiar users who prefer the quickest way to start and operate TempView. Open the *Run* dialog box from the Windows 3.X *Program Manager* or the Windows 95 *Start Menu* button. Next, specify a *.*cfg* configuration file as a command line parameter for the TempView program. Then click OK to execute the command. The *TempView Main Window* opens. At this point, startup is complete.

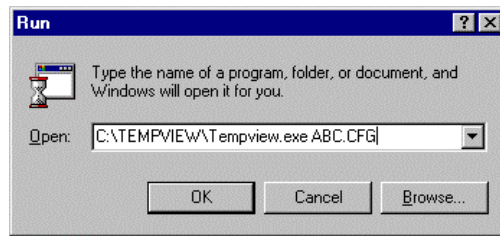

Run Dialog Box

2. The *TempView Startup* dialog box presents you with two options: *Select Device* or *Load File*.

Select Device. Choose *Select Device* if you are a first-time user of TempView, or if no previous configuration file was saved. The *Select Interface* dialog box appears. Continue to Step 3.

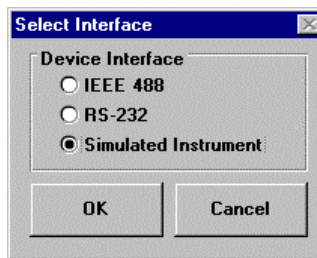

Select Interface Dialog Box

Load File. The *Load File* option is very handy when you want to change the configuration to one used previously. This saves time, especially when using a large acquisition system with numerous channels. If you choose *Load File*, the *Load TempView Setup* dialog box appears. Provide a *.*cfg* configuration file and click OK. The *TempView Main Window* opens. At this point, startup is complete.

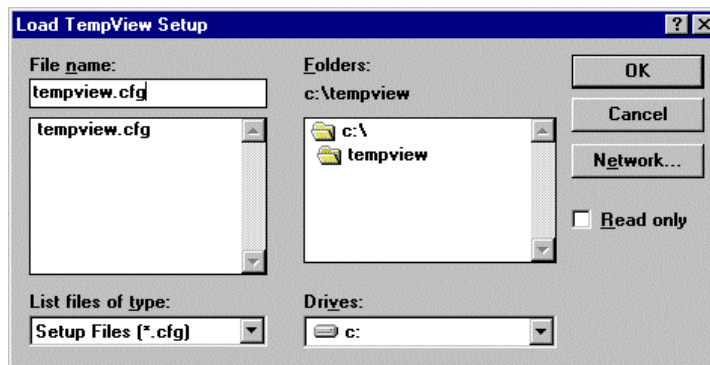

Load TempView Setup Dialog Box

3. The *Select Interface* dialog box presents you with three options: *IEEE 488*, *RS-232*, or *Simulated Instrument*. Select a simulated instrument or the same device interface option (IEEE 488 or RS-232) that you configured for your TempScan/1100 or MultiScan/1200 system.

Simulated Instrument. Choose *Simulated Instrument* if you are a first-time user of TempView. Or choose this option if your acquisition device is not connected. Click OK. The *TempView Main Window* opens. At this point, startup is complete. Feel free to continue your own navigation and exploration throughout the application to gain familiarity with TempView.

Using the *Simulated Instrument* mode to tour TempView provides a means to navigate TempView and inspect its application features without the concern for hardware connections and configuration. But if you prefer otherwise, TempView gives you the option to change the interface mode at anytime during a configuration setup.

IEEE 488. If you choose *IEEE 488*, the *IEEE 488 Setup* dialog box appears. Provide the IEEE 488 Address (0-30). Make sure the address setting matches that set on your TempScan/1100 or MultiScan/1200 rear panel DIP switch. Click OK. The *TempView Main Window* opens. At this point, startup is complete..

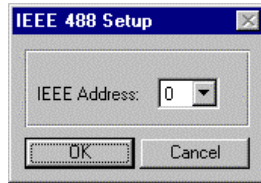

IEEE 488 Setup Dialog Box

RS-232. If you choose *RS-232*, the *RS-232 Setup* dialog box appears. Provide information regarding: Comm Port, Baud Rate, Parity, Handshaking, and Modem. Click OK. The *TempView Main Window* opens. At this point, startup is complete..

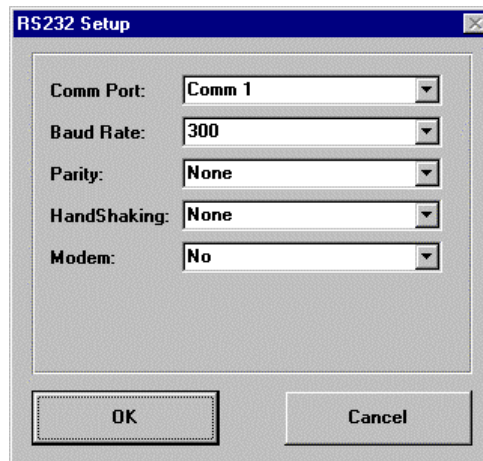

RS-232 Setup Dialog Box

To Set Up an Acquisition Using TempView

1. **For more-familiar users who are now ready to configure an acquisition.** After the *TempView Main Window* opens, indicating that startup is complete, read the following reminder notes:
 - A Personal488 IEEE 488 controller interface supported by Driver488/WIN or Driver488/W95 software, is required for IEEE 488 operation of the TempScan/1100 or MultiScan/1200 system with TempView software.
 - A serial communications interface is required for serial operation of the TempScan/1100 or MultiScan/1200 system with TempView software.
 - Before activating TempView, your TempScan/1100 or MultiScan/1200 acquisition system should be properly connected, configured, and powered-up.

Continue to Step 2.

2. **Review the Acquisition Configuration Checklist.** After reading the reminder notes, review the following *Acquisition Configuration Checklist* prior to starting any data acquisition:
 - **Device Interface.** Check the device interface and status information via the relevant *Device > Interface* and *Device > Status* pull-down menus. It is very important that all TempScan/1100 or MultiScan/1200 users read all of the options available for the *Device* pull-down menu. For more details, see section *Device Menu Items* on page 122.
 - **Channel Configuration.** Check the channel configuration settings within the *Channel Configuration* spreadsheet of the *TempView Main Window*. For more details, see section *Channel Configuration Area* on page 103.

Then, check the channel alarm settings via the *Alarms > Configure Alarms* pull-down menu item. For more details, see section *Alarms Menu Items* on page 127.

 - **Acquisition Parameters.** Check the acquisition parameters within the *Acquisition Configuration* dialog box, via the *Configure Acquisition (11)* toolbar button, or via the *Acquire > Configure Acquisition* pull-down menu item. For more details, see section *Acquire Menu Items* on page 111.
 - **Data File Parameters.** Check the data file parameters within the same *Acquisition Configuration* dialog box, via the *Configure Acquisition (11)* toolbar button, or via the *Acquire > Configure Acquisition*, or also via the *Data > Data File Parameters* pull-down menu item. For more details, see section *Acquire Menu Items* on page 111, or see section *Data Menu Items* on page 117.
3. **Configure the acquisition settings.** After reviewing the *Acquisition Configuration Checklist*, configure the acquisition, as follows:
 - Configure the desired channels. See section *Channel Configuration Area* on page 103.
 - Configure the acquisition. See section *Acquire Menu Items* on page 111.
 - Configure the alarms. See section *Alarms Menu Items* on page 127.
 - **Optional.** Save the configuration file. Although the updated **TEMPVIEW.CFG** configuration file will automatically save upon *Exit*, you may want to manually initiate a save. This will help you save time if an error occurs that may corrupt your configuration. You may also create a new configuration file by making the necessary changes to an existing one. See section *File Menu Items* on page 108.

Note that the ***.cfg** configuration file contains all setup information. Setup information includes channel information, alarm configurations, and acquisition configuration information.

 - **Optional.** Once again, check the system inventory and time via the *Device > Status* pull-down menu. See section *Device Menu Items* on page 122.
4. **Arm the acquisition.** If the above acquisition settings are acceptable, proceed to arm an acquisition via clicking the *Arm Acquisition (12)* toolbar button, or via the *Acquire > Arm Acquisition* pull-down menu item. Again, see section *Acquire Menu Items* on page 111.

TempView Main Window

This section will familiarize you with some of the basic features of TempView. While reading this section, refer to the *TempView Main Window* figures as often as necessary. The *Main Window* items labelled by the lettered and numbered circles are identified in the two respective tables. Because of the graphic design of this application, you should quickly develop a good understanding of the capabilities and operating techniques involved.

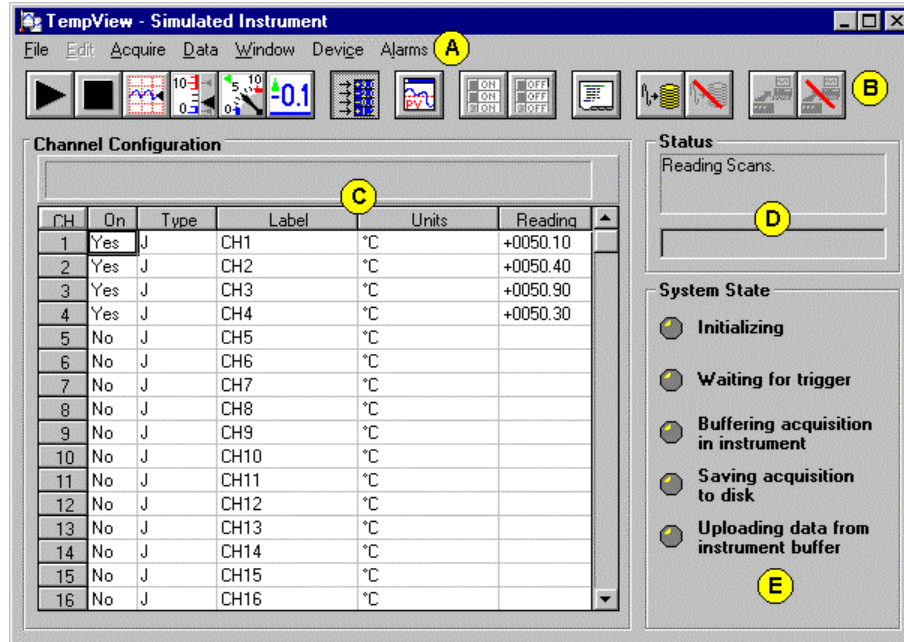

Items labelled by the lettered circles (A to E) are identified in the table below.

TempView Main Window Areas

TempView Main Window Areas			
(X)	Window Area	(X)	Window Area
(A)	Pull-Down Menu Bar	(D)	Status Area
(B)	Toolbar Menu	(E)	System State Area
(C)	Channel Configuration Area		

The *TempView Main Window* consists of one pull-down menu bar (A), one toolbar menu (B), and three bordered areas. Located below the pull-down and toolbar menu bars, the three bordered areas include:

- **Channel Configuration:** This area (C) includes the *Channel Configuration* message box and spreadsheet.
- **Status:** This area (D) includes the *Status* message box and *Upload Progress* bar.
- **System State:** This area (E) includes five indicators.

Located at the top of the *TempView Main Window*, the pull-down menu bar (A) includes the following seven menus:

- *File*
- *Edit*
- *Acquire*
- *Data*
- *Window*
- *Device*
- *Alarms*

Located below the pull-down menu bar, the toolbar menu (B) includes the fifteen toolbar buttons listed and identified in the table.

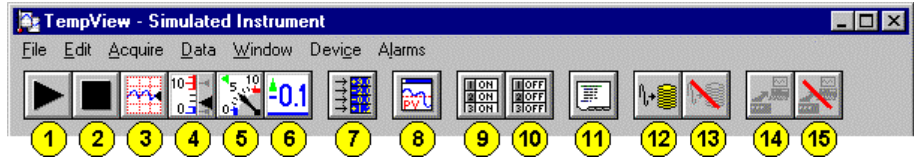

Items labelled by the numbered circles (1 to 15) are identified in the table below.
 Note: When the cursor is placed over any toolbar button (1 to 15), a pop-up label appears.

TempView Toolbar Menu Items

TempView Main Window Toolbar Menu Items				
Button	(#)	Tool Name	Button	(#) Tool Name
	(1)	Start All Indicators (Acquire Pull-Down Menu)		(9) Make All Channels Active (Edit Pull-Down Menu)
	(2)	Stop All Indicators (Acquire Pull-Down Menu)		(10) Make All Channels Inactive (Edit Pull-Down Menu)
	(3)	Charts (Window Pull-Down Menu)		(11) Configure Acquisition (Acquire Pull-Down Menu)
	(4)	Bar Graph Meters (Window Pull-Down Menu)		(12) Arm Acquisition (Acquire Pull-Down Menu)
	(5)	Analog Meters (Window Pull-Down Menu)		(13) Disarm (Acquire Pull-Down Menu)
	(6)	Digital Meters (Window Pull-Down Menu)		(14) Upload Data (Data Pull-Down Menu)
	(7)	Enable Spreadsheet Reading (Acquire Pull-Down Menu)		(15) Stop Upload (Data Pull-Down Menu)
	(8)	PostView post-acq data viewer (Window Pull-Down Menu)		

These *TempView Main Window* components are discussed in further detail in the following text.

Channel Configuration Area

The *Channel Configuration* area (C) of the *TempView Main Window* consists of the *Channel Configuration* message box and spreadsheet. The spreadsheet displays the input channels and allows you to configure them. Each row shows a single channel and its configuration. The number of rows may vary, depending on the number of channels present in your acquisition system. The first four spreadsheet columns – *On*, *Type*, *Label*, and *Units* – allow blocks of cells to be selected and edited at the same time. Clicking a column heading selects the entire column.

When a cell is selected, as shown in the figure, the *Channel Configuration* message box will reveal a configuration note and a pull-down list related to the column of the selected cell. You can change the information contained in the selected cell by either of the following methods:

- Double-clicking on the cell, or
- Making a selection from the message-box pull-down list.

The pull-down list process is better suited when making multiple channel configuration changes within a column. Most of the time, cells will have more than one configuration selection, such as the cells in the columns *On*, *Type*, and *Units*. Double-click repeatedly on a cell to make your way through all the possible selections. The selections are recursive, so you will eventually advance to the same selection you started with.

The following text provides more detail on the *Channel Configuration* spreadsheet parameters:

CH Column

The *CH (Channel)* column serves only as a channel number indicator. The channel number cannot be changed from this window. The maximum channel range for the TempScan/1100 and MultiScan/1200 is 1 through 992, and 1 through 744, respectively.

On Column

The *On* column allows you to enable a channel for data collection. When a cell or block of cells in this column is selected, the *Channel Configuration* message box reveals the following pull-down list options: *Yes* to enable or *No* to disable the channel. You can choose an option by double-clicking on the cell or column heading, or using the pull-down list.

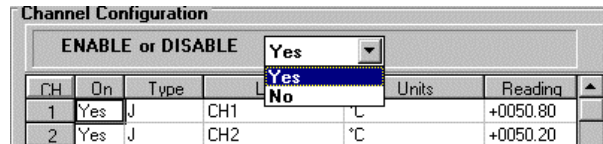

Message Box with an On Column Note

Also, you can activate or deactivate all of the channels by selecting the *Edit > Make All Channels Active* or *Edit > Make All Channels Inactive* menu items, or by clicking on their respective toolbar buttons (9) or (10).

Type Column

The *Type* column allows you to select the desired type of measurement for your scanning card. When a cell or block of cells in this column is selected, the *Channel Configuration* message box reveals the following pull-down list options for *Type*:

Scanning Type Options			
Scanning Unit	Scanning Card	Type Options	Units Options
TempScan/1100	TempTC/32B thermocouple card	J, K, T, E, R, S, B, N(14G), N(28G), or ±100 mV	mX+b, °C, °F, °K, °R
		Volts	mX+b, V, mV
	TempRTD/16B RTD card	RTD	mX+b, °C, °F, °K, °R
MultiScan/1200	MTC/24 thermocouple/volt card	J, K, T, E, R, S, B, N, or ±10 VFS, ±5 VFS, ±1 VFS, ±100 mVFS	mX+b, °C, °F, °K, °R
	MHV/24 high-voltage card	±250 VFS, ±25 VFS, ±2.5 VFS	mX+b, V, mV

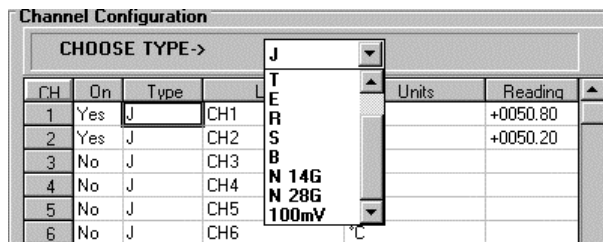

Message Box with a Type Column Note

Label Column

The *Label* column identifies the input channel with a descriptive name. These channel labels also appear in each of the four *TempView Charts and Meters Windows*. When a cell in this column is selected, the *Channel Configuration* message box reveals a note to enter a channel label.

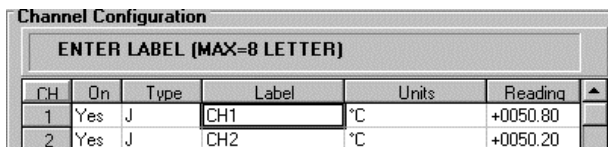

Message Box with a Label Column Note

The default label for each channel is its channel number, but you can change the label to any alphanumeric designation up to eight characters. Each label must be unique (specific) for each designated channel.

Units Column

The *Units* column identifies the unit of measure for each input channel. Cells in the *Units* column are dependent upon the related cells in the *Type* column, and automatically change when the *Type* is changed. For example, when you change a channel from a thermocouple type to a volts type, the temperature units are automatically replaced by volts units. When a cell or block of cells in this column is selected, the *Channel Configuration* message box reveals the pull-down list options for *Units*, as shown in the table below.

Scanning Units Options			
Scanning Unit	Scanning Card	Type Options	Units Options
TempScan/1100	TempTC/32B thermocouple card	J, K, T, E, R, S, B, N(14G), N(28G), or ±100 mV	mX+b, °C, °F, °K, °R
		Volts	mX+b, V, mV
	TempV/32B volts card	RTD	mX+b, °C, °F, °K, °R
MultiScan/1200	MTC/24 thermocouple/volt card	J, K, T, E, R, S, B, N, or ±10 VFS, ±5 VFS, ±1 VFS, ±100 mVFS	mX+b, °C, °F, °K, °R
	MHV/24 high-voltage card	±250 VFS, ±25 VFS, ±2.5 VFS	mX+b, V, mV

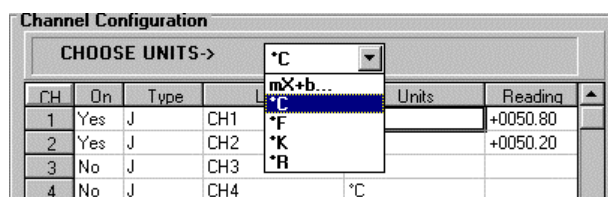

Message Box with a Units Column Note

- **Thermocouple or RTD.** If the channel is configured for temperature (thermocouple or RTD), then the units automatically default to °C (Celsius). At this point, you have the option of selecting a different engineering temperature unit: °F (Fahrenheit), °K (Kelvin), or °R (Rankine). You also have the option of selecting the equation $mX+b$. This option is discussed in the following text.

- **Volts.** If the channel is configured for volts, then the units automatically default to V (volts). At this point, you have the option of selecting mV (millivolts). You also have the option of selecting the equation $mX+b$. This option is discussed below.
- **Equation $mX+b$.** The $mX+b$ equation is typically not used for temperature readings, since temperature data will be linear. However, you may use the equation in temperature applications. For example, you can set b to -32 in order to watch deviations from freezing point when temperature is in $^{\circ}F$.

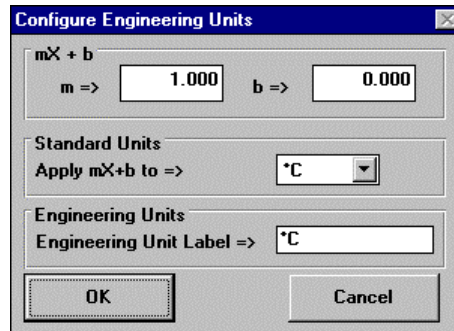

*Configure Engineering Units Dialog Box
(After selecting $mX+b$ for Units)*

When you select the $mX+b$ option, the *Configure Engineering Units* dialog box appears. You are prompted to define m , b , the *Engineering Units Label*, as well as the *Standard Units* to which the $mX+b$ equation should be applied. The *Engineering Units* chosen will be displayed in the *Units* spreadsheet column, and the $mX+b$ equation will be applied to the device reading before the reading is displayed or written to disk. The $mX+b$ option should be used when a channel is reading a voltage needed to calculate a linearly-correlated unattainable reading. In this voltage case, for $mX+b$:

- m is (but not limited to) a non-zero proportionality constant or gain factor.
- X is the scanned-voltage value read back from the TempScan/1100 or MultiScan/1200.
- b is the offset value, or the non-zero value of the *calculated* reading when the *scanned* value is zero.

Reading Column

The *Reading* column displays the input readings of the TempScan/1100 or MultiScan/1200. These readings are real-time channel values which cannot be changed, and which update as fast as the computer will allow. Likewise, other areas of the spreadsheet cannot be changed while the *Reading* column is enabled.

You can activate this column by selecting the *Acquire > Enable Spreadsheet Reading* menu item, or by clicking on its corresponding toolbar button (7).

Status Area

The *Status (D)* and *System State (E)* areas are located on the right-side third of the *TempView Main Window*. These two areas are closely related and are often used in conjunction with each other.

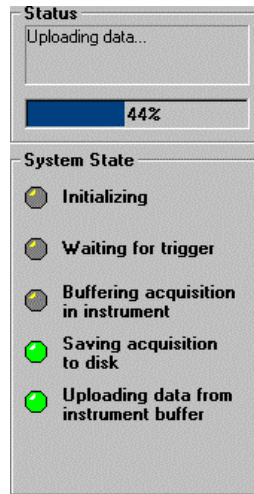

Status & System State Areas

The *Status area (D)* of the *TempView Main Window* includes the following sub-areas:

- **Status:** During an operating task, the *Status* message box reveals a status note to inform you of the status of that present task.
- **Upload Progress:** Located beneath the *Status* message box, the *Upload Progress* bar displays graphical and numerical (percentage) indicators to inform you of the upload progress.

Here are some examples of *Status* messages:

- *Attaching to device*
- *Setting channel configuration*
- *Setting the acquisition parameters.*
- *System idle*
- *Reading scans*
- *Trigger device. Setting acquisition parameters.*
- *Acquisition active. Updating active.*
- *Acquisition active. No updating.*
- *Waiting for trigger*

System State Area

The *System State area (E)* of the *TempView Main Window* includes five labelled indicators for conveying the state of the system. These indicators are dark gray when “off” and bright green when

- *Initializing*
- *Waiting for trigger*
- *Buffering acquisition in instrument*
- *Saving acquisition to disk*
- *Uploading data from instrument buffer*

File Menu Items

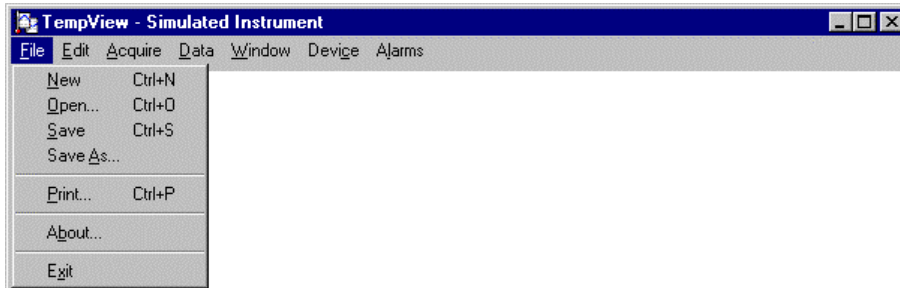

File Menu Items

New (Ctrl + N)

Sets all parameters to their startup (factory default) setting. The *Disarm and Clear Data* dialog box checks your decision to reset all parameters.

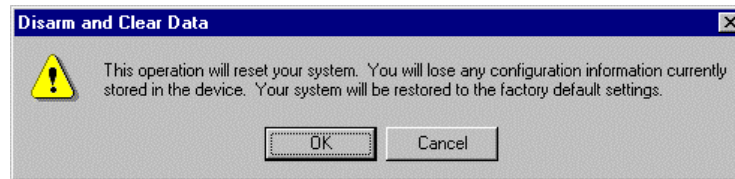

Disarm and Clear Data Dialog Box
(File > New)

Open (Ctrl +O)

Sets all parameters as directed by a specified *.CFG configuration file. The *Load TempView Setup* dialog box prompts you for a selection from a list of configuration files that were previously saved.

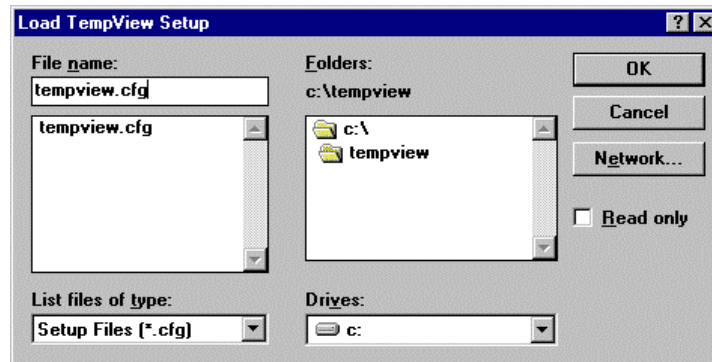

Note: The *Save TempView Setup* dialog box (File > Save As...) looks similar to the *Load TempView Setup* dialog box.

Load TempView Setup Dialog Box
(File > Open)

Save (Ctrl + S)

Saves the existing all-inclusive configuration settings as a *.CFG file for later recall. If the file is named the same as an existing configuration file, then the *Save* command overwrites the existing version.

Save As

Saves the existing all-inclusive configuration settings as a *.CFG file for later recall. The *Save TempView Setup* dialog box prompts you to save the file by either overwriting the original version or saving it under a new filename.

Print (Ctrl + P)

Prompts you to set up a scheduled print out of the input spreadsheet. The *Print Spreadsheet* dialog box appears when this item is selected. For the *Print* function to work, the *Reading* column of the *Channel Configuration* spreadsheet must be activated.

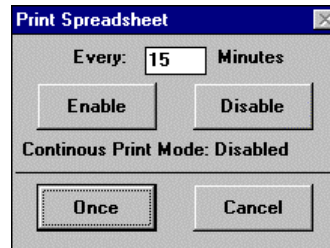

*Print Spreadsheet Dialog Box
(File > Print)*

About

Provides TempView software version information in the *About TempView* dialog box.

Exit

Exits the TempView program.

Edit Menu Items

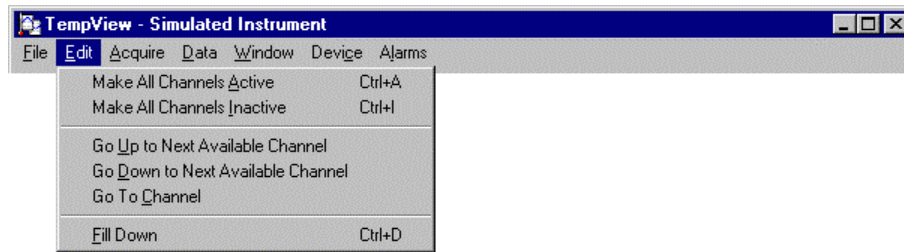

Edit Menu Items

Make All Channels Active (Ctrl + A)



(9)

Places a *Yes* in the *On* column of all channels with a single click. This feature is convenient during setup and troubleshooting, or if only one or two channels must be set differently from the rest. To scan only a few channels, you can make all channels inactive, then turn on the desired channels.

Make All Channels Inactive (Ctrl + I)



(10)

Places a *No* in the *On* column of all channels with a single click. This feature is convenient during setup and troubleshooting or if only one or two channels must be set differently from the rest. To scan only a few channels, you can make all channels inactive, then turn on the desired channels.

Go Up to Next Available Channel

Highlights the next available channel in the rows above the present highlighted channel, and repositions that channel at the top row of the *Channel Configuration* spreadsheet.

Go Down to Next Available Channel

Highlights the next available channel in the rows below the present highlighted channel, and repositions that channel at the top row of the *Channel Configuration* spreadsheet.

Go to Channel

Repositions the desired channel at the top row of the *Channel Configuration* spreadsheet. The *Go To Channel* dialog box prompts you to enter a channel number. For hardware configurations with hundreds of channels, this is a quick way to get from one specific channel to another.

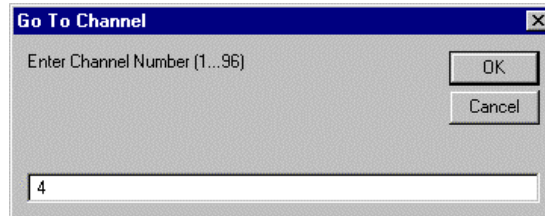

*Go To Channel Dialog Box
(Edit > Go To Channel)*

Fill Down (Ctrl + D)

Copies the value of the top cell in a selected cell group in the same column, and applies that top cell value to all remaining cells in the selected cell group.

Acquire Menu Items

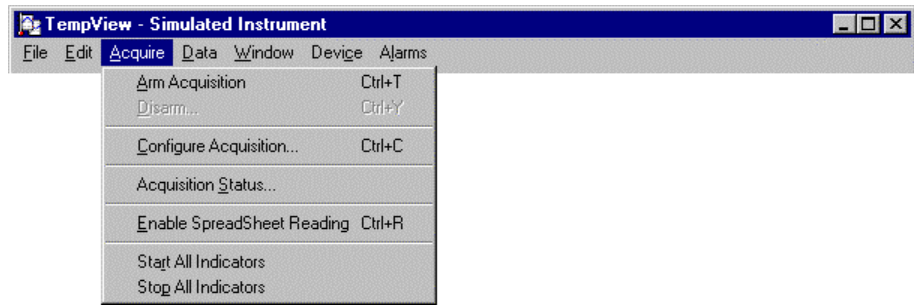

Acquire Menu Items

Arm Acquisition (Ctrl + T)



(12)

Initiates a *Trigger* scan in an acquisition of data to disk. The *Arm Acquisition* command is typically the first step after acquisition configuration has been completed. When this item is selected, one of three cases can follow:

- **Pre-Trigger is not defined:** The *Trigger* option in the *Trigger Event* area (a) of the *Acquisition Configuration* dialog box will determine when the acquisition process is initiated.
- **Pre-Trigger is defined:** The acquisition process begins when the *Arm Acquisition* item is selected.
- **Trigger is the keyboard:** If a keystroke is chosen as the trigger, the *Console Trigger* dialog box will appear when the *Arm Acquisition* item is selected.

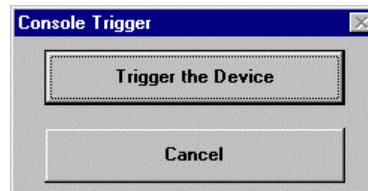

Console Trigger Dialog Box

(If trigger is keyboard, Acquire > Arm Acquisition)

Disarm (Ctrl + Y)



(13)

Deactivates the acquisition of data at any point during an active acquisition. The *Disarm the Acquisition* dialog box appears when this item is selected.

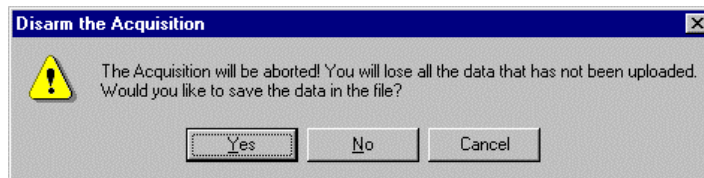

Disarm the Acquisition Dialog Box

(Acquire > Disarm)

Configure Acquisition (Ctrl + C)



(11)

Sets parameters used by the *Arm Acquisition* command for the acquisition of data to disk. When the *Trigger* is satisfied, the scans are collected at the selected scan frequency and stored to disk in the designated file. The *Acquisition Configuration* dialog box will appear when the menu item is selected, and its appearance will be slightly different depending on whether it is accessed via TempScan/1100 mode, MultiScan/1200 *Normal* mode, or MultiScan/1200 *High-Speed* mode.

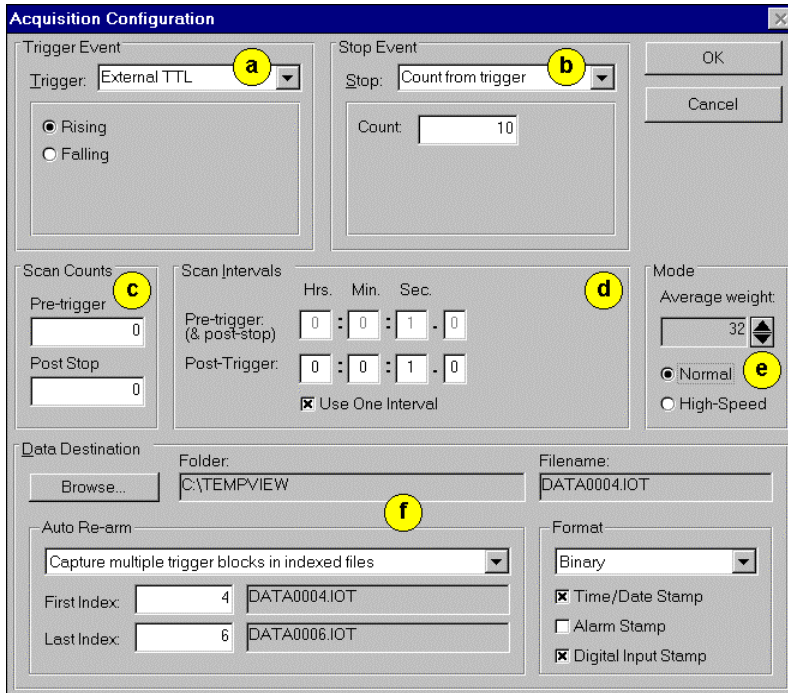

Normal Mode

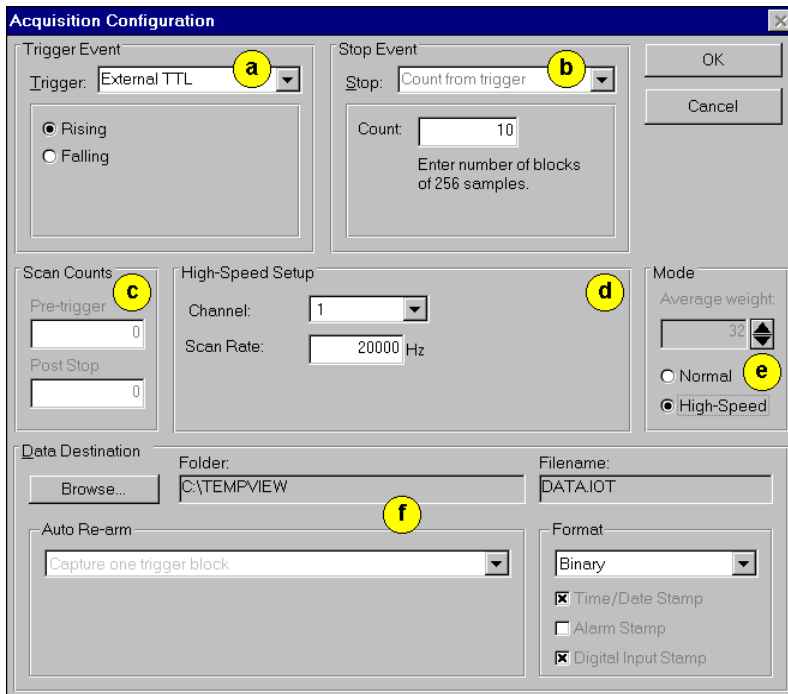

High-Speed Mode

Items labelled by the lettered circles (a to f) are identified in the table below.

*Acquisition Configuration Dialog Box MultiScan/1200 Examples
(Acquire > Configure Acquisition)*

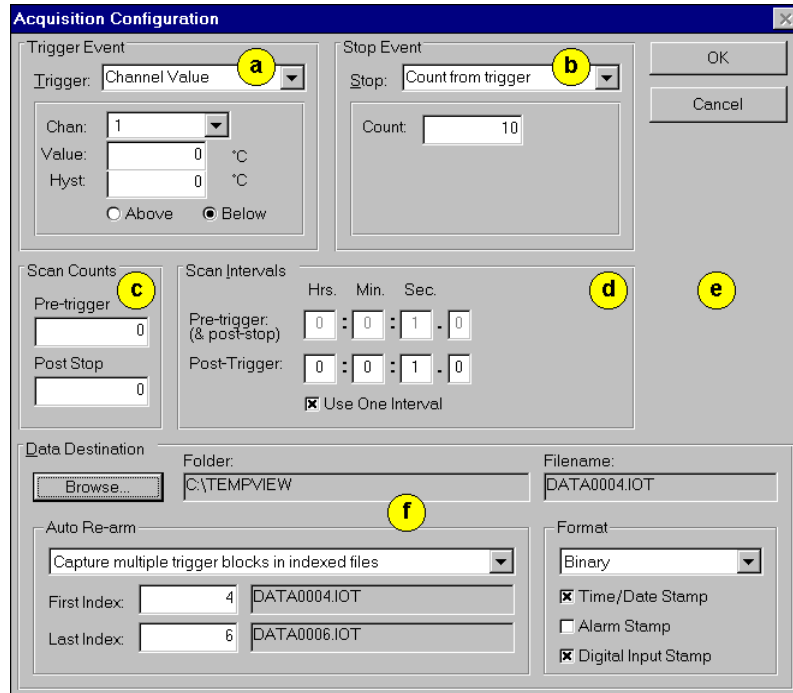

Items labelled by the lettered circles (a to f) are identified in the table below.

*Acquisition Configuration Dialog Box TempScan/1100 Example
(Acquire > Configure Acquisition)*

Acquisition Configuration Dialog Box Areas			
(x) Dialog Box Area	TempScan/1100	MultiScan/1200	
		Normal	High-Speed
(a) Trigger Event Area	Yes	Yes	Yes
(b) Stop Event Area	Yes	Yes	Yes
(c) Scan Counts Area	Yes	Yes	Yes
(d) Scan Intervals (or High-Speed Setup) Area	Scan Intervals	Scan Intervals	High-Speed
(e) Mode Area	No	Yes	Yes
(f) Data Destination Area	Yes	Yes	Yes

The six areas of this dialog box – the *Trigger Event*, *Stop Event*, *Scan Counts*, *Scan Intervals*, *Mode*, and *Data Destination* areas – are discussed in the following text:

- ***Trigger Event.*** The *Trigger Event* area (a) sets a *Trigger* scan in the acquisition by using one of the following options:

Keyboard: Use the *Console Trigger* dialog box via the *Acquire > Arm Acquisition* menu item. See Notes below.

External TTL: Use a *Rising* or *Falling* external signal.

Channel Value: Use *Above* or *Below* channel value for a specified channel.

Alarm: Use a specified *On* or *Off* condition.

Absolute Time: Use a specific time of day, and date. See Notes below.

- **Stop Event.** The *Stop Event* area (b) sets a stop scan in the acquisition by using one of the following options (note that the *Keyboard* is not an option):
 - External TTL:*** Use a *Rising* or *Falling* external signal.
 - Channel Value:*** Use *Above* or *Below* channel value for a specified channel.
 - Alarm:*** Use a specified *On* or *Off* condition.
 - Absolute Time:*** Use a specific time of day, and date. See Notes below.
 - Count from Trigger:*** Specify a number of scans to be read before a stop scan is set.
- **Scan Counts.** The *Scan Counts* area (c) specifies the number of scans – both *Pre-Trigger* and *Post Stop* – in an acquisition.
- **Scan Intervals or High-Speed Setup.** This area (d) changes depending on whether the *Acquisition Configuration* dialog box is accessed via *TempScan/1100* mode, *MultiScan/1200 Normal* mode, or *MultiScan/1200 High-Speed* mode.
 - Scan Intervals.*** When in *TempScan/1100* mode or *MultiScan/1200 Normal* mode, the *Scan Intervals* area appears. This area specifies the time between scans (scan frequency) – during *Pre-Trigger* and *Post-Trigger* – and whether the same single interval is used.
 - High-Speed Setup (MultiScan/1200 Only).*** When in *MultiScan/1200 High-Speed* mode, the *High-Speed Setup* area appears. This area specifies the channel and the scan rate for high-speed, single-channel burst mode.
- **Mode (MultiScan/1200 Only).** The *Mode* area (e) only appears when using a *MultiScan/1200*, indicating either *Normal* or *High-Speed* mode.
 - Data Destination.** The *Data Destination* area (f) formats the data that is generated by the acquisition. This area includes the following sub-areas:
 - Folder:*** The *Folder* box displays the drive and directory to which data will be written.
 - Filename:*** The *Filename* box displays the name of the data file in the above folder.
 - Format:*** The *Format* sub-area specifies whether the data file is saved in ASCII text format (**.TXT*) in Microsoft Excel, or in binary format (**.IOT*). Also, this sub-area specifies the stamp(s) with which the data is marked – *Time/Data Stamp*, *Alarm Stamp*, and/or *Digital Input Stamp*.
 - Auto Re-arm (New Feature):*** The *Auto Re-arm* sub-area allows you to select a large number of acquisitions to take place automatically, with each acquisition using the same configuration settings. The following three *Capture* options are available:
 - *Capture one Trigger Block*
 - *Capture multiple Trigger Blocks in one file*
 - *Capture multiple Trigger Blocks in indexed files*

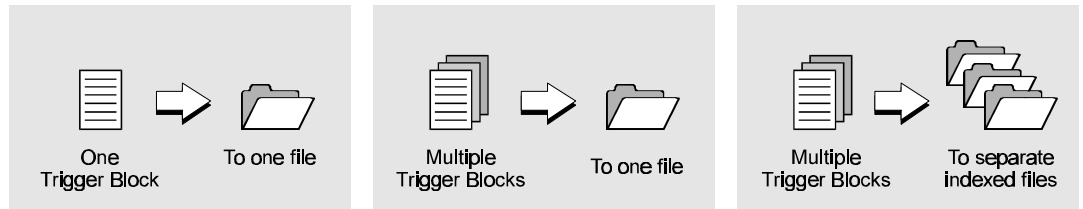

Capture one Trigger Block.

Capture multiple Trigger Blocks in one file.

Capture multiple Trigger Blocks in indexed files.

The *Auto Re-arm* feature is a convenient way to monitor and analyze specific types of trigger events. For example, if you set Channel 1 going above 30°C as a *Trigger*, you can choose to repeat 100 (or more) acquisitions with this same *Trigger* criteria (Channel 1 > 30°C). Whether you select to capture the *Trigger Blocks* in one file or each in a separate file, each of the data acquisitions will occur automatically with your set configuration.

- Note:** The *Auto Re-arm* default setting – *Capture one Trigger Block* – is forced when using a *Keyboard* or *Absolute Time* as the *Trigger*, and when using *MultiScan/1200 High-Speed* mode.
- Note:** If you prefer not to repeat acquisitions with the same configuration settings, select the *Auto Re-arm* default setting – *Capture one Trigger Block*. When you capture only one *Trigger Block* you are, in essence, not making use automatic re-arm.
- Note:** The above *Acquisition Configuration* dialog box areas cannot be changed when an acquisition is in progress.

Acquisition Status...

Displays the condition of a data acquisition. The *Acquisition Status* dialog box will appear when the menu item is selected. New features of this dialog box include the *Current File* and *Scans in* areas, which display the current file name and the number of scans, respectively. This information is helpful when the system is capturing multiple *Trigger Blocks* to separate files, by allowing you to see the system status with respect to the multiple acquisitions.

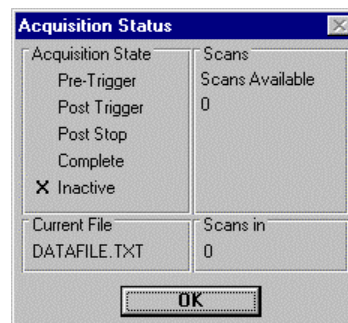

*Acquisition Status Dialog Box
(Acquire > Acquisition Status)*

Enable SpreadSheet Reading (Ctrl + R)



(7)

Enables and disables the *Reading* column of the *Channel Configuration* spreadsheet in the *TempView Main Window*. Enabling this column provides a realtime display of channel data. This function alternately toggles the enabled and disabled state with each selection of the button.

Note: Prior to changing any channel parameter, the *Reading* column, and the *TempView Charts and Meters Windows* must all be stopped and no data acquisition can be in progress.

Start All Indicators



(1)

Starts all selected or open indicators for the *Reading* column, and the *TempView Charts and Meters Windows*. Alternatively, you may start any of the active *TempView Charts and Meters Windows* separately by using their own *Start* toolbar button.

Note: Prior to changing any channel parameter, the *Reading* column, and the *TempView Charts and Meters Windows* must all be stopped and no data acquisition can be in progress.

Stop All Indicators



(2)

Stops all selected or open indicators for the *Reading* column, and the *TempView Charts and Meters Windows*. Alternatively, you may stop any of the active *TempView Charts and Meters Windows* separately by using their own *Stop* toolbar button.

Note: Prior to changing any channel parameter, the *Reading* column, and the *TempView Charts and Meters Windows* must all be stopped and no data acquisition can be in progress.

Data Menu Items

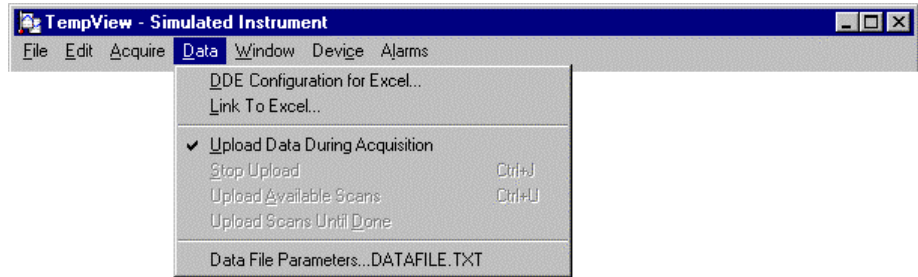

Data Menu Items

DDE Configuration for Excel

Configures the DDE (Dynamic Data Exchange) operation of TempView. The *DDE Configuration for Excel* dialog box appears when this item is selected, and allows you to dynamically load collected TempView data into an open Microsoft Excel spreadsheet.

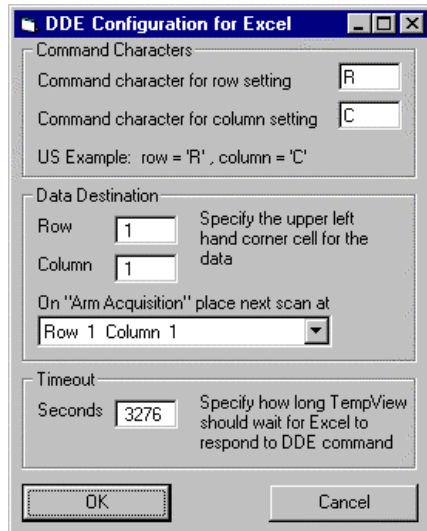

"Arm Acquisition" pull-down list not selected.

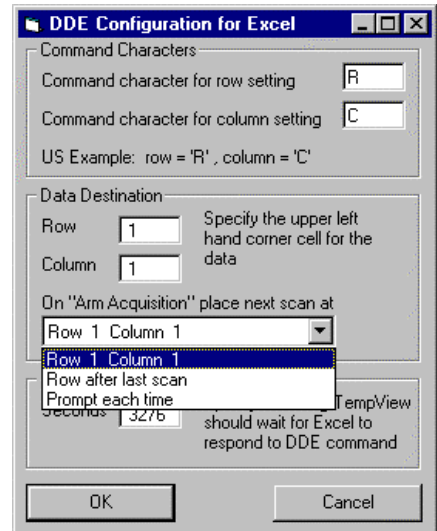

"Arm Acquisition" pull-down list selected

DDE Configuration for Excel Dialog Box
(Data > DDE Configuration for Excel)

The three areas of this dialog box – the *Command Characters*, *Data Destination*, and *Timeout* areas – are discussed in the following text:

- **Command Characters:** This area contains two fields for entering command characters: One for the row setting and one for the column setting. Enter the set of characters which matches the applicable version of Microsoft Excel. For example:

For France: Row = L, Column = C

For Germany: Row = Z, Column = S

For the United States: Row = R, Column = C.

- **Data Destination:** The *Data Destination* area allows you to assign the data destination on the Microsoft Excel spreadsheet. Specify the data starting point by entering a number for row, and another for column. The two numbers designate the upper left hand corner cell of the Excel data entry.

Within this area, the "Arm Acquisition" pull-down list allows you to select one of three options for positioning data in Excel on subsequent scans. The following three options are available:

Row # Column #. This option starts the next scan at the designated row and column on the Excel spreadsheet. Changing the values in the *Row* and *Column* boxes will automatically enter the new values in the corresponding fields of the *Row # Column #* placement assignment. For example, if you entered a 3 in the row box and a 5 in the column box, you would see *Row 3 Column 5*, instead of *Row 1 Column 1*. Consequently, the next scan would start at row 3 column 5 in Excel.

Row after last scan. When *Row after last scan* is selected, the next scan will begin at the point in Excel where the previous acquisition left off.

Prompt each time. When *Prompt each time* is selected, after each acquisition is completed a dialog box will ask if you want to *Return to Origin*. If you select *Yes*, you will have an overwrite on the Excel spreadsheet, starting with the existing column and row designation. If you select *No*, the next scan will begin on the spreadsheet row after the scan (from where the previous acquisition left off).

- **Timeout:** The *Timeout* area allows you to enter a DDE link timeout value from 5 to 3276 seconds. This value represents how long the data import to Excel can be suspended while you perform a second Excel activity, such as displaying graphs. A screen message informs you when the DDE link is timed out, terminating the DDE link to Excel.

Link to Excel

Enables the data file to be opened in Microsoft Excel. The *Sheet Name* dialog box appears when this item is selected. Note that Microsoft Excel must already be running.

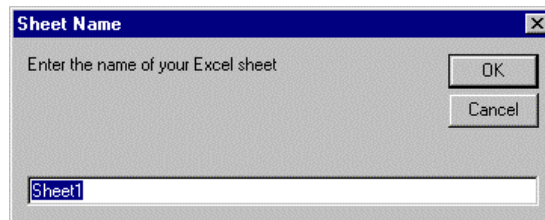

*Sheet Name Dialog Box
(Data > Link To Excel)*

Upload Data During Acquisition (Automatic Control)



(14)

Enables TempView, during an active acquisition, to retrieve scans from the TempScan/1100 or MultiScan/1200 memory buffer as data becomes available.

The acquisition-to-disk has a higher priority than the updating of the *Reading* column of the *Channel Configuration* spreadsheet, or any of the *TempView Charts and Meters Windows*. Therefore, data is displayed as soon as the acquisition task is satisfied. As the scan rate is increased, the acquisition-to-disk task will take up more processor (CPU) time and the displaying of data will be updated as time allows. Note that if you select linear conversion ($mX + b$) as the units for channel configuration, you should expect a further delay on data availability.

Stop Upload (Ctrl + J) (Manual Control)



(15)

Disables TempView from accessing TempScan/1100 or MultiScan/1200 memory for data. TempView will be disabled even if the acquisition is not complete.

Upload Available Scans (Ctrl + U) (Manual Control)

Enables TempView to access TempScan/1100 or MultiScan/1200 memory for all scans currently available. Note that this function only uploads scans that are currently available and nothing else.

Upload Scans Until Done

Enables TempView to access TempScan/1100 or MultiScan/1200 memory and to upload scans until scanning is complete.

Data File Parameters...

Allows you to specify the data file name and destination. The *Select Data File Name* dialog box appears when this item is selected. Note that the data file extension (`*.txt` or `*.iot`) reflects the data format selection made in the *Data Destination* area (f) of the *Acquisition Configuration* dialog box. To change the data format, you must use the *Acquisition Configuration* dialog box.

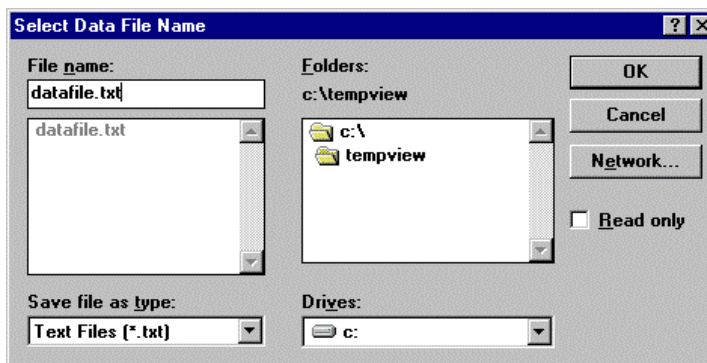

*Select Data File Name Dialog Box
(Data > Data File Parameters)*

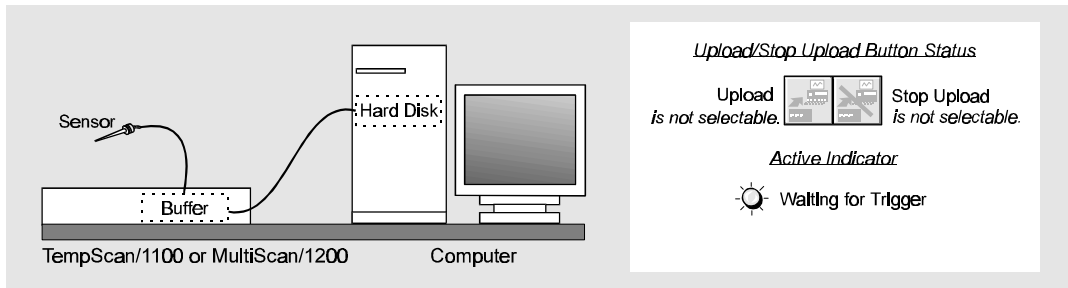

1) Waiting for Trigger

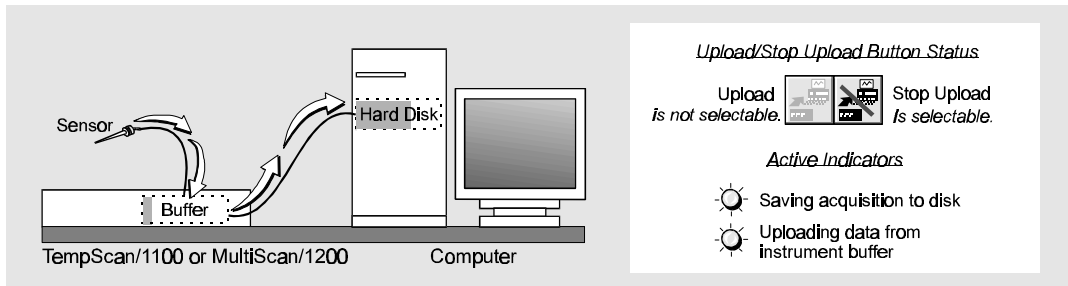

2) Acquiring & Uploading Acquisition

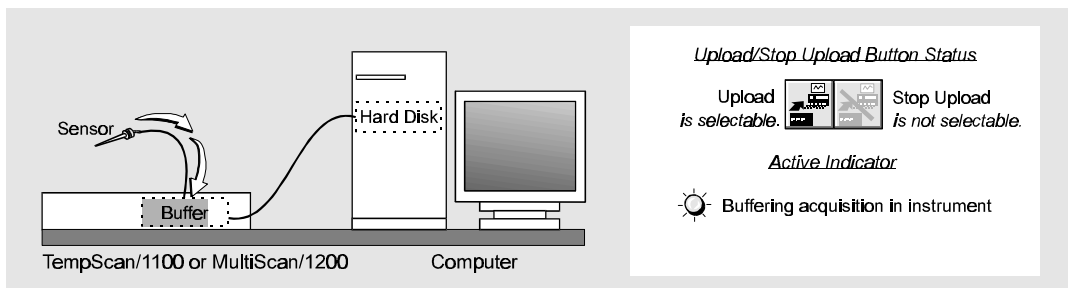

3) Buffering Acquisition in Instrument

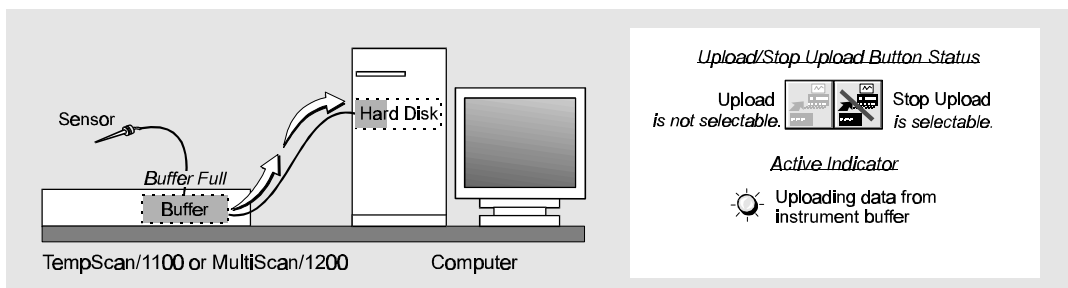

4) Uploading Data from Instrument Buffer

Data Upload States

Window Menu Items

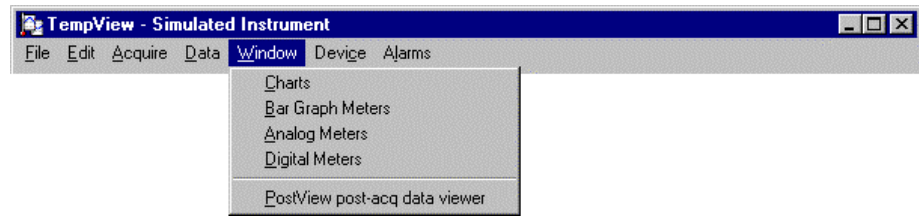

Window Menu Items

Charts



(3)

Opens the *TempView Charts* window, which displays real-time data in a strip-chart format. For more information, see section *TempView Charts & Meters Windows* on page 129.

Bar Graph Meters



(4)

Opens the *TempView Bar Graph Meters* window, which displays real-time data in a bar-graph format. For more information, see section *TempView Charts & Meters Windows* on page 129.

Analog Meters



(5)

Opens the *TempView Analog Meters* window, which displays real-time data in an analog format. For more information, see section *TempView Charts & Meters Windows* on page 129.

Digital Meters



(6)

Opens the *TempView Digital Meters* window, which displays real-time data in a digital format. For more information, see section *TempView Charts & Meters Windows* on page 129.

PostView post-acq data viewer



(8)

Starts the PostView application software, and opens the *PostView Main Window*. For more information, see chapter *PostView*.

Device Menu Items

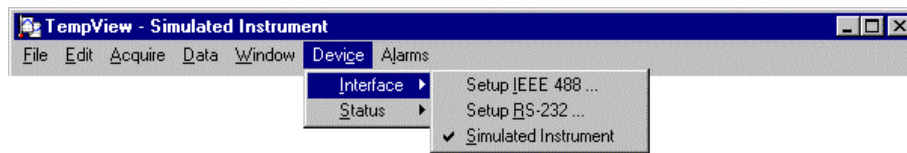

Device > Interface Menu Items

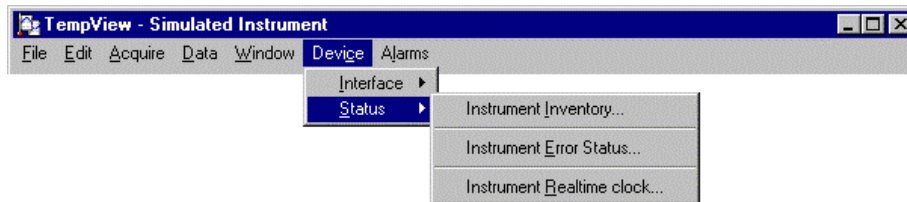

Device > Status Menu Items

Interface > Setup IEEE 488...

Opens the *IEEE 488 Setup* dialog box, which displays the current *IEEE 488 Address*. During a first-time startup, this dialog box appears when you select the IEEE 488 interface. At any time outside of an acquisition, you can reset the address with an appropriate value from 0 to 30.

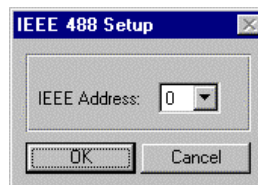

*IEEE 488 Setup Dialog Box
(Device > Interface > Setup IEEE 488)*

Interface > Setup RS-232...

Opens the *RS-232 Setup* dialog box, which displays the current options for the following RS-232 fields:

- ***Comm Port:*** Integer value between 1 and 16.
- ***Baud Rate:*** 300, 600, 1200, 2400, 4800, or 9600.
- ***Parity:*** None, Odd, or Even.
- ***Handshaking:*** None or RTS/CTS.
- ***Modem:*** No or Yes.

During a first-time startup, this dialog box appears when you select the RS-232 interface. At any time outside of an acquisition, you can reset these items with their appropriate options.

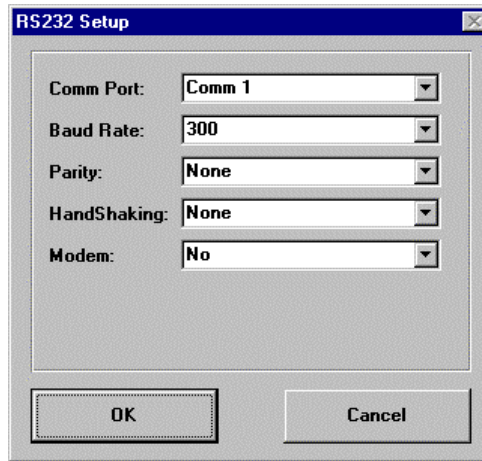

*RS-232 Setup Dialog Box
(Device > Interface > Setup RS-232)*

Interface > Simulated Instrument

Starts a new session of TempView without the requirements for hardware connections and configuration. During a first-time startup, the *Simulated Instrument* option appears in the *Select Interface* dialog box, and is strongly recommended for the beginner as a means to navigate TempView and inspect its application features without hardware concerns. Note that if your TempScan/1100 or MultiScan/1200 is not connected, you must select *Simulated Instrument* as your device interface.

Status > Instrument Inventory...

Displays a spreadsheet as a current checklist of the TempScan/1100 or MultiScan/1200 master unit, the Exp/10A and/or Exp/11A expansion units, as well as the scanning card types and positions. The *System Inventory* dialog box appears when this item is selected, and the information on its *System Configuration* spreadsheet cannot be changed.

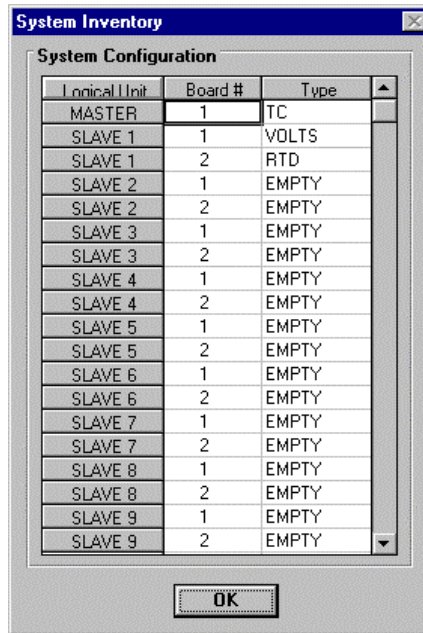

*System Inventory Dialog Box
(Device > Status > Instrument Inventory)*

Status > Instrument Error Status...

Displays a field as an error record of all the TempScan/1100 or MultiScan/1200 system errors in the current TempView session. The *Device Error Status* dialog box appears when this item is selected, and its information cannot be changed until it is cleared by the reinitialization of another TempView session. Note that this menu item can be selected during, as well as outside, an acquisition.

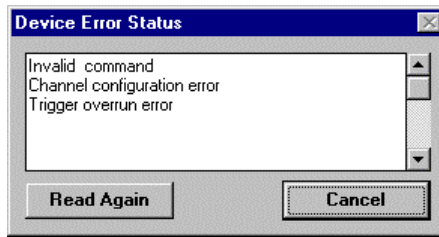

Device Error Status Dialog Box
(*Device > Status > Instrument Error Status*)

Status > Instrument Realtime Clock...

Displays the exact system time and date at which this item is selected. The *Device System Time* dialog box appears, and allows you to reset any of the following components of the system time: *Hours*, *Min (minutes)*, *Sec (seconds)*, *Tenth (tenths of a second)*, *Month*, *Day*, and *Year*.

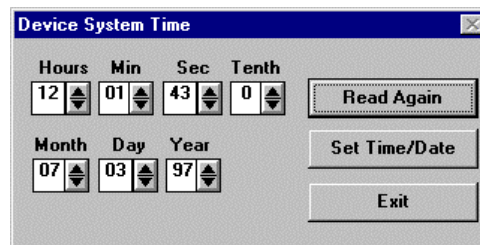

Device System Time Dialog Box
(*Device > Status > Instrument Realtime Clock*)

Device Menu Items (Expanded)

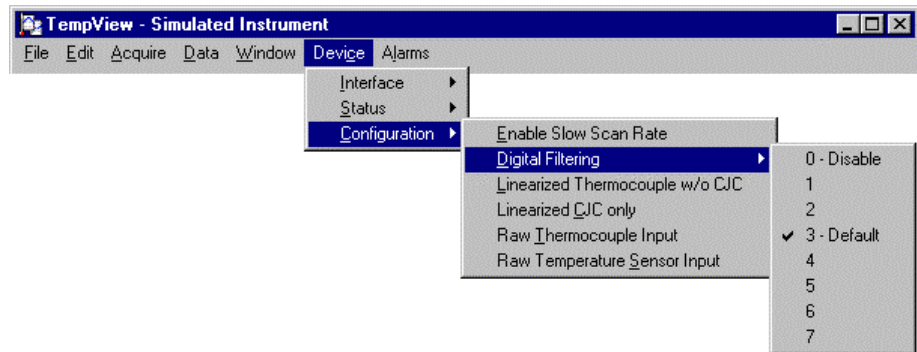

*Device > Configuration Menu Items
(Expanded after pressing <F12>)*

You can expand the *Device* pull-down menu by pressing the <F12> function key on your computer keyboard prior to pulling down the menu. After pressing <F12>, the *Device* pull-down menu will list a third menu item named *Configuration*.

The expanded menu setting is not saved in the configuration file when you exit TempView. So if the expanded menu is desired, you must press <F12> each time you start TempView. A discussion of the *Device > Configuration* menu items is presented below.

Note: When the MultiScan/1200 is used, the *Enable Slow Scan Rate* and *Digital Filtering* items do not apply and do not appear in the *Device > Configuration* menu.

Configuration > Enable Slow Scan Rate (TempScan/1100 Only)

Reduces the scan rate by a factor of 4, from 16 to 4 readings per line cycle. This feature allows for increased settling time when measuring signals through long lengths of wire. The factory default for the TempScan/1100 system is *fast scan rate*.

Configuration > Digital Filtering (TempScan/1100 Only)

Selects the setting for the digital filter. TempScan/1100 uses an advanced software digital filter to ensure quiet and accurate input from thermocouples. The settings for the digital filter range from a value of 0 to 7. The factory default for the filter value is 3, while a filter value of 0 will disable the filter. Higher digital filter values will make signals quieter and more accurate, but will increase the response time.

Configuration > Linearized Thermocouple w/o CJC

Note: This menu item is not for normal operation, and exists primarily for use by technicians as an aid in troubleshooting thermocouple channel types (31 to 39). Operation is the same as normal operation, but without temperature sensor adjustment (CJC or cold-junction compensation). For more information, see command *Configure Channels* (c) in the chapter *API Command Reference*.

Configuration > Linearized CJC only

Note: This menu item is not for normal operation, and exists primarily for use by technicians as an aid in troubleshooting thermocouple channel types (41 to 49). Operation involves linearized temperature sensor values (CJC or cold-junction compensation) only. For more information, see command *Configure Channels* (c) in the chapter *API Command Reference*.

Configuration > Raw Thermocouple Input

Note: This menu item is not for normal operation, and exists primarily for use by technicians as an aid in troubleshooting thermocouple channel types (51 to 59 for the TempScan/1100; or 40 for the MultiScan/1200). Operation involves no temperature sensor adjustment, or raw analog-to-digital (A/D) input of the thermocouple type. For more information, see command *Configure Channels* (c) in the chapter *API Command Reference*.

Configuration > Raw Temperature Sensor Input

Note: This menu item is not for normal operation, and exists primarily for use by technicians as an aid in troubleshooting thermocouple channel types (50). Operation involves unlinearized temperature sensor values only, or raw analog-to-digital (A/D) input of the temperature sensors. For more information, see command *Configure Channels* (c) in the chapter *API Command Reference*.

Alarms Menu Items

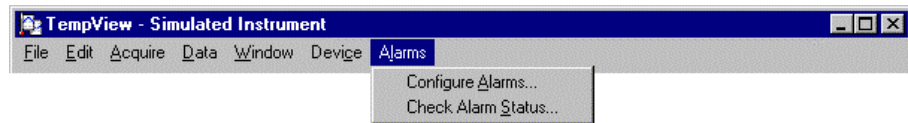

Alarms Menu Items

Configure Alarms...

Provides a means of setting the low limit, high limit, and the hysteresis value for each input channel in the system. The *Configure Alarms* dialog box appears when this item is selected. Entering a hysteresis value allows you to set the channel so that the “chatter” phenomena is avoided.

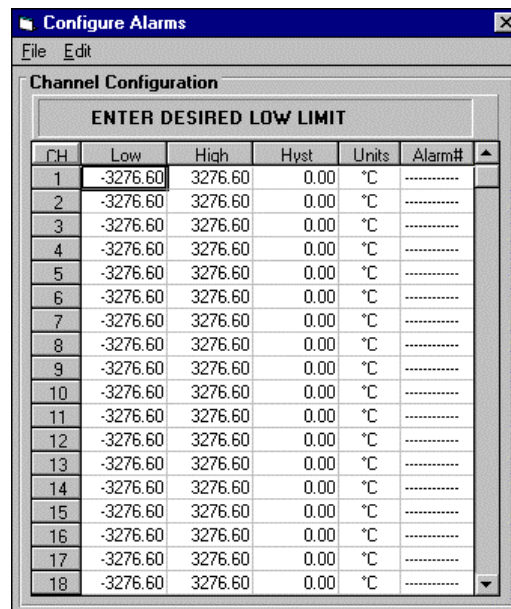

*Configure Alarms Dialog Box
(Alarms > Configure Alarms)*

In addition to setting the limits and hysteresis, you can assign an alarm number (1 to 32 for the TempScan/1100; or 1 to 24 for the MultiScan/1200) to each input channel. An alarm number is associated with one digital output. However, any number of channels can be assigned to a single alarm number. A given digital output will be set true (1) if at least one of the channels assigned to it goes into an alarm condition.

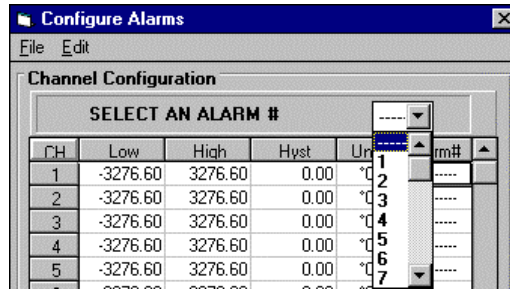

Message Box with Alarm# Column Note

Check Alarm Status...

Displays the current state of each alarm. The *Alarm Status* dialog box appears when this item is selected. The alarm state appears as either a digital High (1) or digital Low (0). A one-for-one correlation between the alarm number and the channel can occur, only if each dedicated alarm number corresponds to a single unique channel in the system.

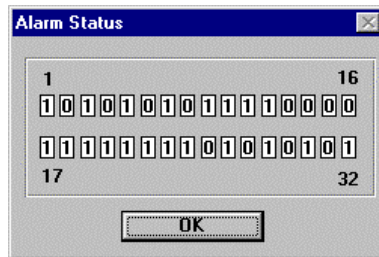

Alarm Status Dialog Box
(Alarms > Check Alarm Status)

TempView Charts & Meters Windows

As with the *TempView Main Window* figure, refer to these *TempView Charts & Meters Windows* figures as often as necessary. The items labelled by the lettered and numbered circles are identified in the two respective tables.

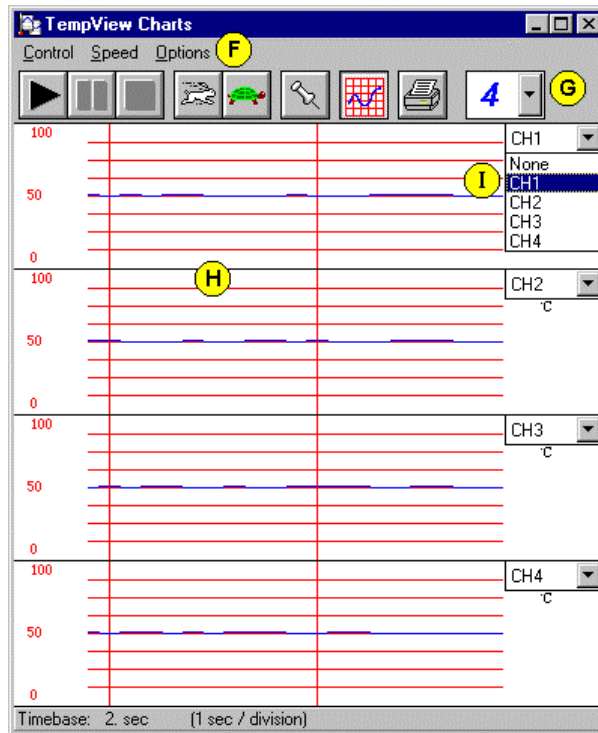

Items labelled by the lettered circles (F to I) are identified in the table below.

TempView Charts Window Areas

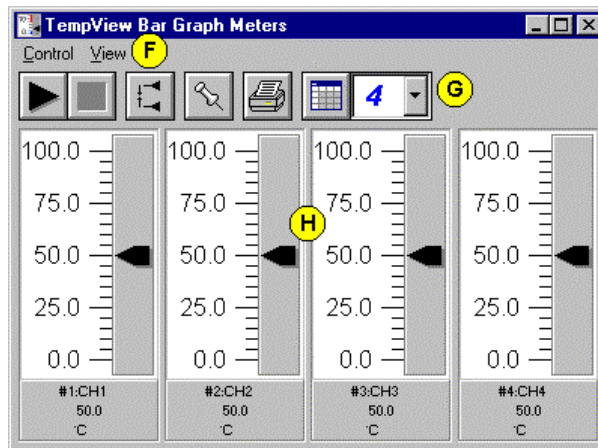

Items labelled by the lettered circles (F to H) are identified in the table below.

TempView Bar Graph Meters Window Areas

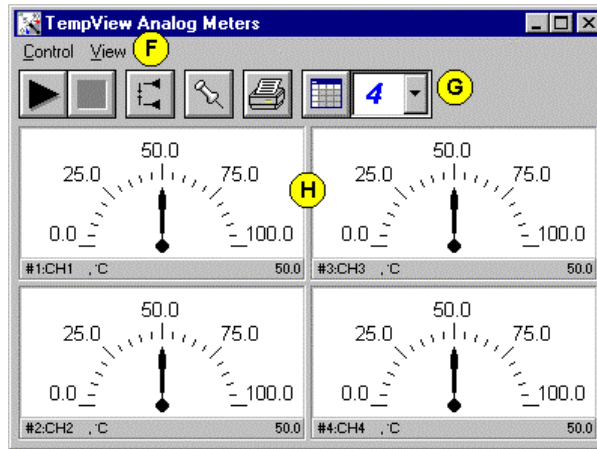

Items labelled by the lettered circles (F to H) are identified in the table below.

TempView Analog Meters Window Areas

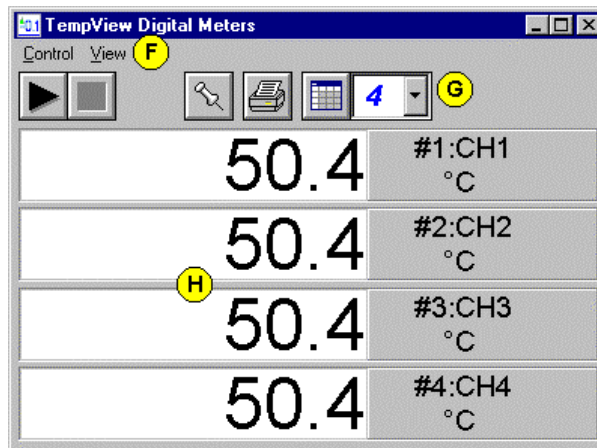

Items labelled by the lettered circles (F to H) are identified in the table below.

TempView Digital Meters Window Areas

TempView Charts & Meters Window Areas			
(X)	Window Area	(X)	Window Area
(F)	Pull-Down Menu Bar	(H)	Channel Display Area
(G)	Toolbar Menu	(I)	Active Channel Pull-Down List

Each of the *TempView Charts & Meters Windows* consists of one pull-down menu bar (F), one toolbar menu (G), and the *Channel Display* (H) area.

Located at the top of the *TempView Charts Window*, the pull-down menu bar (F) includes the following three menus:

- *Control*
- *Speed*
- *Options*

Meanwhile, at the top of each *TempView Meters Window*, the pull-down menu bar (F) includes the following two menus:

- *Control*
- *View*

Located below the pull-down menu bar, the toolbar menu (G) includes a subset of the eleven toolbar buttons listed and identified in the table below.

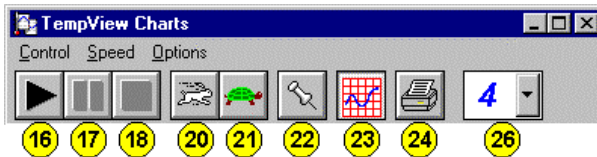

Charts

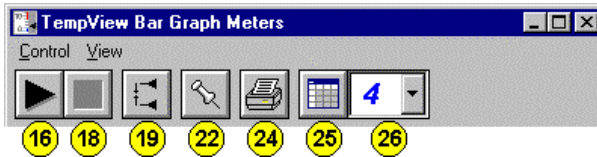

Bar Graph Meters

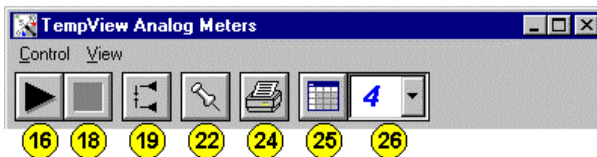



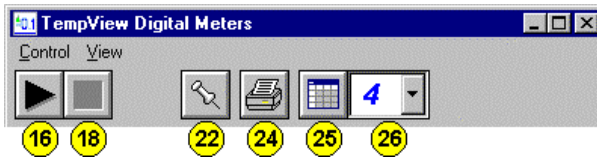







Analog Meters



Digital Meters

Items labelled by the numbered circles (16 to 26) are identified in the table below.
Note: When the cursor is placed over any toolbar button (16 to 25), a pop-up label appears.
Note: The *Digital Meters Window* has no pull-down, toolbar, or pop-up menu items referring to Peak Hold.

TempView Charts & Meters Toolbar Menu Items

TempView Charts & Meters Toolbar Menu Items					
Button	(#)	Tool Name	Button	(#)	Tool Name
	(16)	Start (Control Pull-Down Menu)		(22)	Stay On Top (Options Pull-Down Menu) (View Pull-Down Menu)
	(17)	Pause (Control Pull-Down Menu)		(23)	Show Grids (Options Pull-Down Menu)
	(18)	Stop (Control Pull-Down Menu)		(24)	Print (Charts/Meters) (Options Pull-Down Menu) (View Pull-Down Menu)
	(19)	Reset Peak Hold (Indicator) (Control Pull-Down Menu) (Pop-Up Menu)		(25)	Rows x Columns (View Pull-Down Menu)
	(20)	Faster (Speed Pull-Down Menu)		(26)	Number of Charts/Meters (Options Pull-Down Menu) (View Pull-Down Menu)
	(21)	Slower (Speed Pull-Down Menu)			

These *TempView Charts & Meters Windows* components are discussed in further detail in the following text.

Channel Display Area

With any of the *TempView Charts & Meters Windows*, the *Channel Display* area (**H**) consists of the single or multiple display of selected channels. However, the channel-display configuration of the *Charts Window* and the *Meters Windows* involves the following differences:

- **Charts Window:** At the top-right corner of each channel display, an *Active Channel* pull-down list (**I**) is located. To assign an active channel to a chart, click on the pull-down list (**I**), and a channel list will appear. Select the desired channel. When no active channel is selected the box reads *None*.

For the selected active channel, you can change the minimum or maximum values on the left-hand side of the channel display, by using your cursor to highlight the upper or lower limit, respectively, then typing in the new limit, and pressing the **<Enter>** key. The new limits will take effect and a new mid-range value will automatically appear.

- **Meters Windows:** To configure any of the Meters channel displays, click the right mouse button while the cursor is on the selected channel of the *Channel Display* area (**H**), and a pop-up menu will appear. For more detail on this pop-up menu, see section *Configure Meter Pop-Up Menu Items (Meters Only)* on page 137.

Control Menu Items (Charts & Meters)

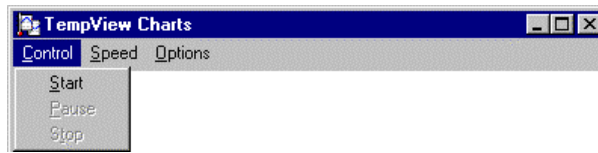

Control Menu Items

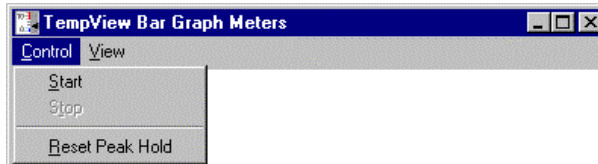

This menu is similar for all three Meters Windows.
Note: The Reset Peak Hold item does not appear in the Digital Meters menu.

Control Menu Items

Start (All Charts & Meters)



(16)

Enables the *Channel Display* area (H) of any of the *TempView Charts and Meters Windows*.

With Charts, before the display is started, at least one channel must be enabled from the *TempView Main Window*, and at least one chart must be assigned to an active (enabled) channel. To assign an active channel to a chart, you can use the *Active Channel* pull-down list (I).

With any of the Meters, before the display is started, at least one channel must be enabled from the *TempView Main Window*.

Alternatively, you can also start the *Channel Display* area in all opened *TempView Charts and Meters Windows* by using the *Start All Indicators* toolbar button (1).

Note: Prior to changing any channel parameter, the *Reading* column, and the *TempView Charts and Meters Windows* must all be stopped and no data acquisition can be in progress.

Pause (Charts Only)



(17)

Pauses your view of the chart, but does not affect the scan rates of the TempScan/1100 or MultiScan/1200 acquisition.

Stop (All Charts & Meters)



(18)

Disables the *Channel Display* area (H) of any of the *TempView Charts and Meters Windows*.

Alternatively, you can also stop the *Channel Display* area in all opened *TempView Charts and Meters Windows* by using the *Stop All Indicators* toolbar button (2).

Note: Prior to changing any channel parameter, the *Reading* column, and the *TempView Charts and Meters Windows* must all be stopped and no data acquisition can be in progress.

Reset Peak Hold (Bar Graph & Analog Meters Only)



(19)

Resets the floating markers. Upon reset, the markers will instantly adjust to indicate the highest and lowest values reached since the time of the reset. This menu item also appears in the *Configure Meters* pop-up menu. Note that this feature does not appear in the Digital Meters *Control* menu.

Speed Menu Items (Charts Only)



Speed Menu Items

Faster



(20)

Speeds up your view of the chart but does not affect the scan rates of the TempScan/1100 or MultiScan/1200 acquisition.

Slower



(21)

Slows down your view of the chart but does not affect the scan rates of the TempScan/1100 or MultiScan/1200 acquisition.

Options Menu Items (Charts Only)

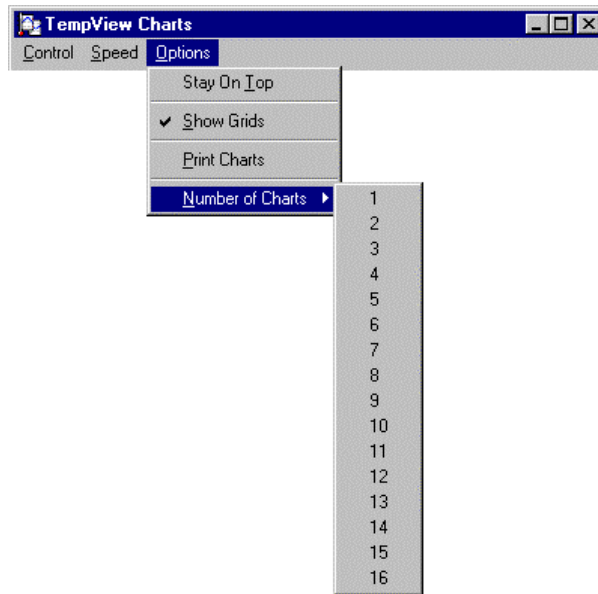

Options Menu Items

Stay On Top



(22)

Enables and disables "pinning" the window on top of other windows. This menu item also appears in any of the Meters *View* menus.

Show Grids



(23)

Adds and removes a grid to your chart.

Print Charts



(24)

Sends the display image to the connected printer. This menu item has the same function as the *Print* menu item in any of the Meters *View* menus.

Number of Charts



(26)

Specifies the number of charts to appear on the screen. This menu item has the same function as the *Number of Meters* menu item in any of the Meters *View* menus.

View Menu Items (Meters Only)

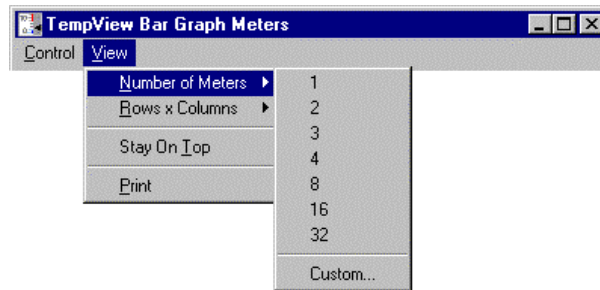

This menu is similar for all three Meters Windows.

View > Number of Meters Menu Items

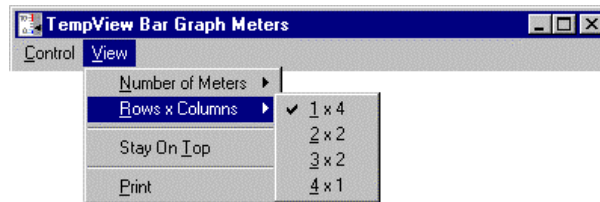

This menu is similar for all three Meters Windows.

View > Rows x Columns Menu Items

Number of Meters



(26)

Specifies the number of meters to appear on the screen. This menu item has the same function as the *Number of Charts* menu item in the *Charts Options* menu.

Rows x Columns



(25)

Opens a small menu with *Row x Column* options to rearrange the display for convenient reading. For example, when the *Number of Meters* is 6, the *Rows x Columns* options will be: 6x1, 3x2, 2x3, and 2x4 with the first number being the number of rows. If you then select 3x2 you will have 3 rows of meters with 2 meters per row.

Stay On Top



(22)

Enables and disables "pinning" the window on top of other windows. This menu item also appears in the *Charts Options* menu.

Print



(24)

Sends the display image to the connected printer. This menu item has the same function as the *Print Charts* menu item in the *Charts Options* menu.

Configure Meter Pop-Up Menu Items (Meters Only)



This menu is similar for all three Meters Windows.

Note: The Show & Reset Peak Hold Indicator items does not appear in the Digital Meters menu.

*Configure Meter Pop-up Menu Items
(Click on right mouse button in Meters Channel Display)*

Unlike the *TempView Charts Window*, each *TempView Meters Window* features a *Configure Meter* pop-up menu. Access this menu as follows:

1. If not already done so, open the desired *TempView Meters Window*.
2. Place the mouse cursor over the desired channel of the *Channel Display* area (**H**).
3. Click on the right mouse button. A pop-up menu will appear. Note that the *TempView Digital Meters Window* has no pull-down, toolbar, or pop-up menu items referring to Peak Hold.

Select Channel

Selects an active channel for the desired meter display.

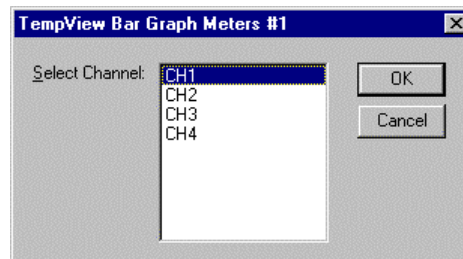

This dialog box is similar for all three Meters Windows.

*TempView Meters Select Channel Dialog Box
(Pop-Up Menu > Select Channel)*

Set Scale

Sets the high and low points of the scale, and defines the decimal place format.

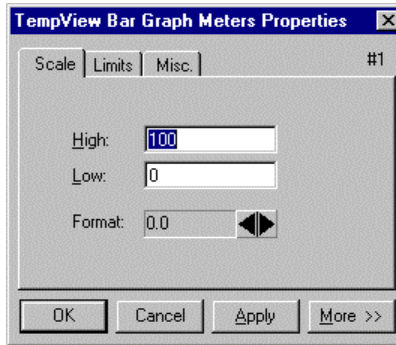

This dialog box is similar for all three Meters Windows.

*TempView Meters Properties Dialog Box - Scale Tab
(Pop-Up Menu > Set Scale) and (Pop-Up Menu > Properties)*

Show Peak Hold Indicator (Bar Graph & Analog Meters Only)

Places high and low uni-directional floating markers on the scale to indicate the highest and lowest values reached up to the present time. Note that this feature does not appear in the Digital Meters pop-up menu.

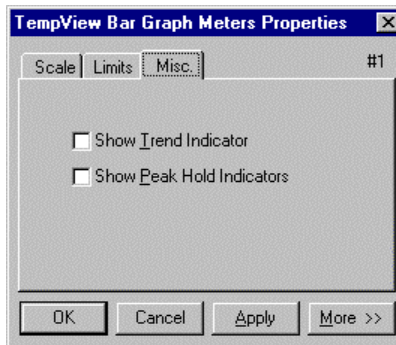

This dialog box is similar for all three Meters Windows.

Note: The Show Peak Hold Indicator item does not appear in the Digital Meters dialog box.

*TempView Meters Properties Dialog Box - Miscellaneous Tab
(Pop-Up Menu > Show Peak Hold Indicators), (Pop-Up Menu > Show Trend Indicator)
and (Pop-Up Menu > Properties)*

Reset Peak Hold Indicator (Bar Graph & Analog Meters Only)



(19)

Resets the floating markers. Upon reset, the markers will instantly adjust to indicate the highest and lowest values reached since the time of the reset. This menu item also appears in the Bar Graph and Analog Meters *Control* menu. Note that this feature does not appear in the Digital Meters pop-up menu.

Show Trend Indicator

Displays a pointer to indicate the direction of the trend. Note that during rapid-meter fluctuations the increase and decrease pointers will appear to blink simultaneously.

Set Limits

Sets the high and low limits for the display of a channel.

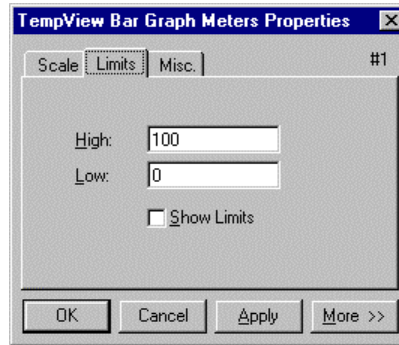

This dialog box is similar for all three Meters Windows.

TempView Meters Properties Dialog Box - Limits Tab
(Pop-Up Menu > Set Limits), (Pop-Up Menu > Show Limits) and (Pop-Up Menu > Properties)

Show Limits

Displays the limits by assigning colors to the scale regions which equal and fall outside the set limit values. A red region indicates values which equal or exceed the upper limit, while a blue region indicates values which equal or fall below the lower limit. For the *TempView Digital Meters Window*, the upper limits are indicated by the numerals turning red and a red bar appearing at the top of the box, while the lower limits are indicated by the numerals turning blue and a blue bar appearing at the bottom of the box.

Properties

Allows general access to any one of the above pop-up menu items. Note that you can navigate from any one of the above menu items to another within the same *TempView Meters Properties* dialog box.

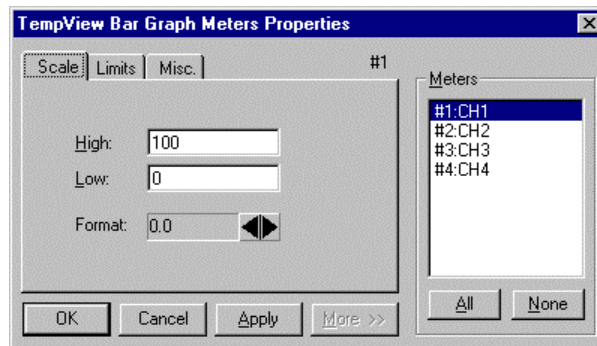

This dialog box is similar for all three Meters Windows.

TempView Meters Properties Dialog Box - More Button & Expansion Area
(Pop-Up Menu > [Any Menu Item] > More Button)



Notes

Introduction	141
Starting PostView	143
Toolbar	144
Channel Information Region	145
Pull-Down Menus	146
File Menu.....	146
Go To Menu.....	146
Options Menu.....	146
Help Menu.....	146
Groups, Charts & Channels	147
Chart Setup Wizard	147
Introduction.....	147
Automatic Chart Creation.....	148
Display Configuration Setup	149
Editing a Display.....	150
Manually Creating a Display.....	152
PostView Timebase	155
Data File Accessibility	155

Introduction

PostView is a Windows-based post-acquisition data-review application that can be started independently or from within ChartView or TempView. This application allows you to view ChartView-recorded or TempView-recorded waveforms, and to access ChartView or TempView files at any time, even during an acquisition. As the data file is being created, a corresponding PostView descriptor file is also created. If PostView reaches the end of a file while ChartView or TempView is still collecting data, PostView will automatically display the new data as it becomes available. In addition, PostView allows you to invoke multiple sessions simultaneously to view multiple data files.

From this point on, the ChartView and TempView programs will also be referred to as “acquisition programs.”

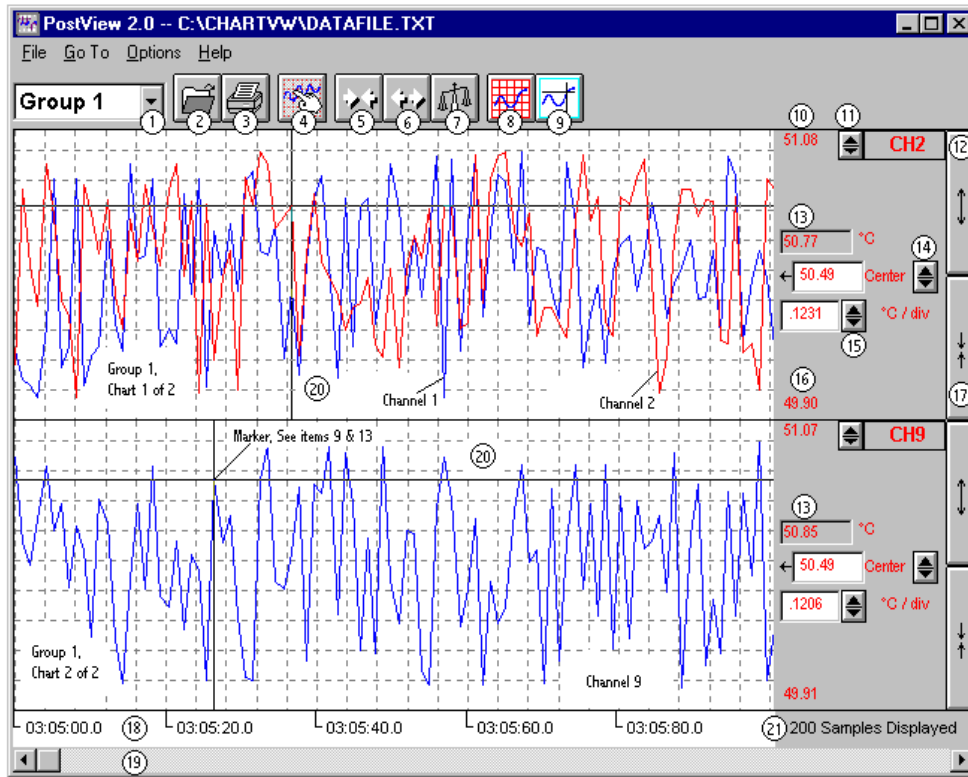

PostView Control Options ¹			
⌘ = Mouse, ⇧ = Arrow Keypads, ⇩ = PageUp/PageDown Keypads			
1	Group Select	⌘, Ctrl+G, ⇧, or ⇩	
2	Open	⌘, or Ctrl+O	
3	Print	⌘, or Ctrl+P	
4	Setup	⌘, or Ctrl+S	
5	Zoom Out	⌘	
6	Zoom In	⌘	
7	Scale	⌘	
8	Show Grid	⌘	
9	Show Marker	⌘	
10	Chart Max Scale Value ²	Setup Dialog Box	
11	Channel Selection ²	⌘, or ⇧	
12	Multiply (x2) ²	⌘, or [spacebar]	
13	Value at Marker ²	-----	
14	Offset ²	⌘, ⇧, or type-in	
15	Units/Division ²	⌘, ⇧, or type-in	
16	Chart Min. Scale Value ²	Setup Dialog Box	
17	Divide (÷2) ²	⌘, or [spacebar]	
18	Time Stamp	Hours: mins: seconds. Tenths	
19	Scroll	⌘	
20	Access Chart Setup	⌘ Right-click to edit setup of selected chart.	
21	Number of Samples Displayed	Automatic indication of no. of samples per chart	

¹ **Note:** For keypad options, first use the *Tab* key to "tab over" to the desired control item. For example, you can use the tab key to highlight the Group Select (item 1), then use any of the following 3 methods to obtain the desired group: Ctrl+G, keypad arrows, or PageUp/PageDown keys.

² **Note:** Items 10 through 17 are discussed in the section *Channel Information Region*, page 145.

Starting PostView

There are two primary ways of starting PostView:

1. Open PostView directly from the Windows Explorer, Desktop Icon, or Start Run browse feature (on desktop).
2. From the acquisition program's main window, click on the toolbar's PostView button, or select PostView from the pull-down menu.

Each of these methods is illustrated in the following figure. Actions in the decision diamond are performed automatically by PostView and require no user action.

Method 1: Open PostView Directly from Windows Explorer, Desktop Icon, or Start Run browse

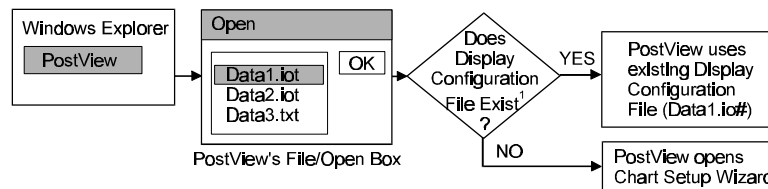

Method 2: Open PostView from ChartView, or other Data Acquisition Program

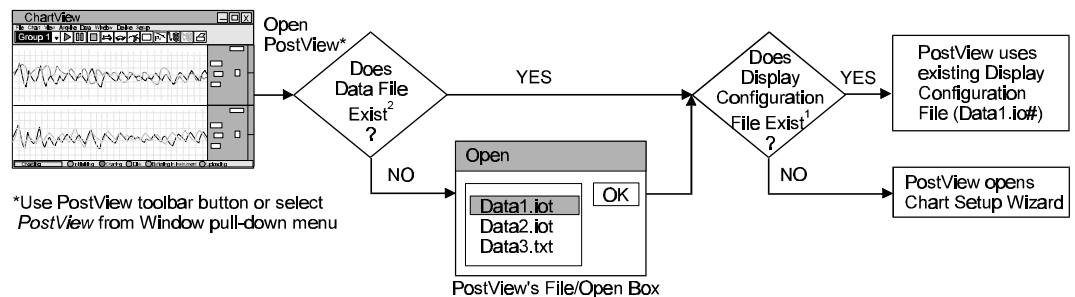

¹**Note:** PostView automatically checks for Display Configuration files. These files are automatically saved when exiting your data acquisition program, but may also be manually saved by the user. These files are recognized by **.io#** or **.tx#** filename extensions.

²**Note:** PostView automatically checks for data files. These files are recognized by **.iot** or **.txt** filename extensions.

³**Note:** Several PostView screens can be active at the same time; allowing you to view different data files during the same session. To view a data file from PostView, select *Open* under PostView's File menu, and select the desired data file.

Two Basic Methods of Opening PostView

As you can see in the previous figure, when you first open PostView the program checks for the existence of a data file. If no data file can be found, PostView displays its File Open dialog box, allowing you to select the desired file. In addition, PostView checks for a Display Configuration File. These Display Configuration Files have a **.io#** extension (for binary files) or **.tx#** extension for ASCII files. If no Display Configuration File is found, PostView activates the Chart Setup Wizard, providing you with a means of setting up the type of display you want in regard to the number of chart groups, number of charts per group, channel assignments for each chart, and types of channels.

The method of configuring the display setup is discussed later in this chapter. Users familiar with the Chart Setup Wizard feature (in ChartView and ChartView Plus) will find that PostView makes use of the exact same feature.

Toolbar

The following table explains PostView toolbar items, while the next page begins a description of PostView Menu items. Menu and toolbar items are shown in the figure below.



PostView Toolbar Items		
Item #	Item	Description
1	Group Select	This feature indicates the chart group which is being charted. Clicking on the down arrow (▼) reveals other chart groups configured by the user. To select a different chart group, simply pull down the group list and select the desired group. The group list can be obtained by any of the following control options: a) clicking the down arrow (▼), b) using Ctrl + G on the keyboard, c) using the keyboard up or down arrow key, d) using the page up or page down key. If using a control option other than "a," you may need to select the <i>group select</i> box by repeatedly pressing the keyboard's <i>Tab</i> key until the <i>group select</i> box is selected. When this happens the name of the currently selected group appears in white on a dark background.
2	Open	Accesses the Open Data File window.
3	Print	Sends the PostView chart(s) to an assigned printer.
4	Display Configuration	The Display Configuration button accesses a <i>Display Configuration Setup</i> dialog box. This box will also be displayed if <i>manual setup</i> is selected during use of the Wizard Chart Setup program. Clicking on the button accesses a <i>Display Configuration Setup</i> box which displays the configured structure of the groups, charts, and channels. From this box you can select the number of charts to be assigned to a specific group. With the use of the mouse cursor you can also select a chart or channel for additional editing. Display Configuration is discussed in more detail, immediately after description of the pull-down menu options.
5	Zoom Out (><)	The Zoom Out button doubles the visible timebase, showing more of the waveform. For example, if 10 seconds of information is visible, clicking the Zoom Out button will show 20 seconds.
6	Zoom In (<>)	The Zoom In button halves the visible timebase, showing less of the waveform. For example, if 10 seconds of information is visible, clicking the Zoom In button will show 5 seconds.
7	Autoscale Y-axis Adjust	Clicking the Auto Scale button adjusts the Y-axis labels so that the visible waveform fills 90% of the chart's range. The Y-axis Adjust fields show the chart's minimum and maximum for currently selected charts in the engineering units shown. Clicking the Auto Scale button automatically adjusts the Y-axis Adjust fields.
8	Show Grid	Places a grid on the chart (s), or removes the grid if already present.
9	Show Markers Trigger Event Marker Stop Event Marker	Each chart contains a cross-hair marker that shows the numerical values of time and magnitude at its present location in the waveform. The Markers start out at the far left of every chart, showing the time and magnitude of the first visible point. <i>Ctrl+Left Mouse Button</i> moves the markers from all the charts <i>in unison</i> . The Options menu contains a function which allows you to turn markers on and off. When a check appears in front of this item, its associated indicator is on or visible. Selecting the menu item toggles the indicator (and the check mark) on and off. The Trigger Event Marker on the time axis shows the location of the trigger point. (See figure, <i>PostView TimeBase</i>) The Stop Event Marker on the time axis shows the location of the stop point. (See figure, <i>PostView TimeBase</i>)

The Scroll Bar at the bottom of the PostView window allows the waveforms to be scrolled right or left in two ways:

1. When clicked on, the small left and right arrow boxes scroll the waveforms approximately 20%.
2. The plain scroll button shows the relative location of the visible region of the waveforms and can be dragged along the scroll bar to any location desired.

Channel Information Region

By clicking on the up or down arrows (▲, or ▼) by the channel selection box (item 11), you can select one of a maximum of 4 channels that were assigned to that chart. You could then observe the chart-related information for that specific channel. You can also select a new channel for the information region by placing the cursor in (or tabbing over to) the “Center” or “Units/Div” fields and then pressing PageUp or PageDown. This is particularly useful when your main window has been re-sized such that the channel selection boxes are not visible.

The following list identifies the various areas of the region.

- (10) Chart Max. Scale Value (Grid Limit Line)
- (11) Channel Selection (Of chart’s available channels)
- (12) Multiply (x2)
- (13) Present Value
- (14) Center(Value at chart mid-line)
- (15) Units/Division (Provides vertical increment of one grid box.)
- (16) Chart Min. Scale Value (Grid Limit Line)
- (17) Divide (÷2)

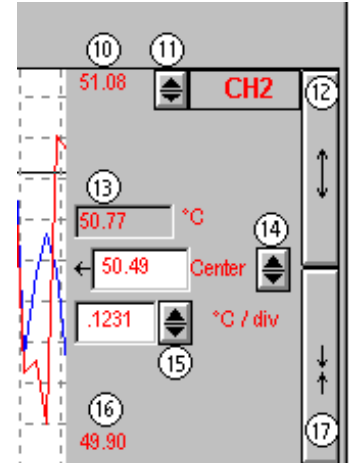

Multiply and Divide Buttons - In addition to reading channel values, you can increase or decrease the size of the selected channel’s chart. This is accomplished with the **Multiply** (12) and **Divide** (17) push-buttons. The Multiply push-button effectively increases the size of the selected channel’s chart by a factor of 2, while automatically adjusting the chart’s high and low values (items 10 and 16). Aside from “clicking” on the Multiply/Divide controls, you can use your keyboard spacebar to control this feature once the button (12 or 17) is selected. Selection may be with mouse, or by tabbing over to the control.

Making changes to a channel’s chart parameters does not affect the parameters of the other channels, with the following exception: Holding the keyboard’s control key down while adjusting either spinner (▲/▼) for *center* (item 14), or spinner for *units/div* (item 15) causes the parameter change to apply to all channels displayed for the chart, not just the currently selected channel display. This feature applies to the spinners and keyboard up and down arrow keys, but not to the text input.

Center Control - The **Center** control (item 14) changes the value of the selected channel’s chart centerline. Changing the value of *center* results in an automatic change of the chart’s high and low end values (items 10 and 16), and possibly an automatic change of the units/div (item 15). Aside from using the *center* spinner controls to change center, you can change the center value by placing the mouse cursor in (or tabbing over to) the field and then either typing in the desired value, or using the PC keyboard up and down arrow control keys.

Units/div - The units in **units/div** (15) can be °C, °F, °K, °R, mV, or V. The division referenced is one vertical grid. In the example above for Channel 1, each vertical grid increment represents 0.1231°C per division. Changing the units/division spinner controls (▲/▼) will result in an automatic adjustment of the max scale and min scale values (items 10 and 16). Aside from using the units/div triangular controls to change the value, you can change units/div from the Display Configuration Setup dialog box as described on page 149.

Pull-Down Menus

The following tables pertain to functions allowed by the pull-down menus.

File Menu

<u>O</u> pen	Opens a data file created by the data acquisition program. PostView automatically detects whether the file contains ASCII or binary data.
<u>P</u> rint	Prints the present PostView window.
<u>S</u> etup	Accesses Display Configuration Setup dialog box, allowing you to edit the display configuration.
<u>E</u> xit	Exits the File menu.

Go To Menu

<u>P</u> ercentage (Ctrl+P)	Automatically scrolls the waveform such that the displayed waveform begins at the specified percentage.
<u>S</u> can Number (Ctrl+S)	Automatically scrolls the waveform such that the displayed waveform begins at the specified scan number.
<u>T</u> ime (Ctrl+m)	Automatically scrolls the waveform such that the displayed waveform begins at the specified time.
<u>T</u> rigger Point (Ctrl+T)	Automatically scrolls the waveform such that the displayed waveform begins at the trigger point (t=0).

Options Menu

<u>Z</u> oom Graph <u>O</u> ut	Allows more of a chart(s) to be seen by decreasing the dimensions.
<u>Z</u> oom Graph <u>I</u> n	Zooms in on a chart(s), providing more detail to a smaller area of the chart(s).
<u>Z</u> oom Chart	Z oom Chart causes the PostView to display one chart only. For example, if you were viewing 3 charts and desired to get a better view of Chart 2, you could use Zoom to view Chart 2 using the full chart viewing area, as compared to using one third of the area. The zoom feature can also be invoked by double-clicking in the chart region of the chart for which you want to apply the zoom. Once you have zoomed in on a chart, the pull-down menu Zoom option is replaced by a R estore option. Selecting R estore from the menu will return the main window to its previous multiple chart viewing status. The restore feature can also be invoked by again double-clicking in the chart region.
Autoscale <u>C</u> urrent Channel	For the currently selected channel, automatically generates a scale, in contrast to manually assigning the scale.
Autoscale <u>A</u> ll Channels	Automatically generates a scale for each channel in every chart of the selected group.
Show Grid (Ctrl+G)	Allows grids to be turned off and on for all visible graphs. When a check appears in front of an item, its indicator is on or visible.
Show Markers (Ctrl+K)	Allows markers to be turned off and on for all visible graphs. When a check appears in front of an item, its indicator is on or visible.

Help Menu

<u>C</u> ontents	The initial PostView help screen provides an overview and listing of the help file contents. A single topic can be selected for quick access to help information.
<u>S</u> earch	Type a word or select one from the Show Topics list for quick access to help information.
<u>H</u> elp on Help	Provides instructions on how to use a Windows Help system.
<u>A</u> bout	Provides the PostView version number, for example: Version 1.5.

Groups, Charts & Channels

As indicated in the figure on page 143, when no display configuration file is found, PostView opens the *Chart Setup Wizard* to assist you in creating a display file. To make the best use of *Chart Setup Wizard* you need to understand the relationship of Groups, Charts, and Channels. The *Chart Setup Wizard* feature is discussed immediately following this text.

Group. “Group” refers to a group of charts. You can add and remove groups to your display, and you can add or remove charts to each group. Depending on the capabilities of your PC, you can have up to 64 groups assigned to your display.

Note: PostView can only display data from one group at a time.

Chart. A “Chart” is a display area containing up to four channels. You can assign up to 16 charts per group. Charts can be displayed with or without gridlines.

Channel. “Channel” refers to a signal channel. You can have up to 4 channels assigned to one chart. Channels will be displayed in units of °C, °F, °K, °R, mV, V, or *user defined* units, depending on the configuration and type of signal conditioning card which was used during data acquisition.

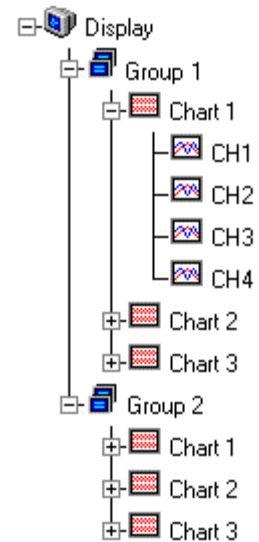

Chart Setup Wizard

Introduction

Chart Setup Wizard is a feature of ChartView, ChartView Plus and PostView. This section discusses the *Chart Setup Wizard* as it relates to PostView.

The feature allows you to create PostView’s initial chart display configuration with an automated or manual method. When PostView can not locate a display configuration file, it automatically accesses the *Chart Setup Wizard* feature. If a display configuration file is located, PostView bypasses the *Chart Setup Wizard*.

Note: When PostView bypasses the *Chart Setup Wizard* you still have an option of editing the display configuration file. This is accomplished by accessing the *Display Configuration Setup* dialog box from *Setup* in the *File* pull-down menu, or by clicking on the Chart Setup button in PostView’s toolbar. Editing is discussed in the section, *Display Configuration*.

The chart display setup determines how your *PostView* window will appear in regard to the following:

- Number of chart groups available for viewing
- Number of charts shown for each selected group
- The number of overlapping channels in each chart (not to exceed 4)

You can choose to manually create a display configuration, or have one created automatically. The automatic setup method offers three choices: Simple, Moderate, and Advanced.

A *Manual Chart Creation*, **Create Charts** button allows you to bypass the *Chart Setup Wizard* and enter a manual editing mode. This option makes use of PostView's Display Configuration feature (discussed in the following *Display Configuration* section). Manual Chart Creation allows you to vary the number of assigned channels per chart, as well as vary the number of charts per group.

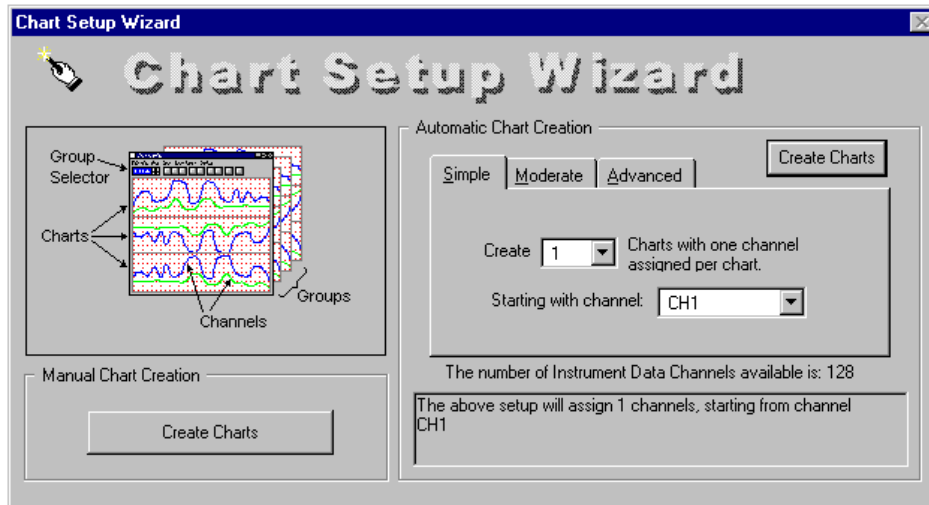

Chart Setup Wizard, Simple Mode

Chart Setup Wizard, Automatic Setup Options for PostView			
Setup Type	Group Setup (for Chart Groups)	Chart Setup	Channel Setup
S imple	1 group only	Up to 16 charts	1 channel per chart
M oderate	1 group only	Up to 16 charts	Up to 4 overlapping channels per chart
A dvanced	Up to 64 groups	Up to 16 charts per group	Up to 4 overlapping channels per chart

Note: The *Manual Charts Creation*, **Create Charts** button (above figure) allows you to exit the *Chart Setup Wizard* and enter the manual *Display Configuration* mode.

Automatic Chart Creation

The previous figure shows the Simple mode dialog box for Automatic Chart Creation. The following figures show the Moderate and Advanced mode dialog boxes.

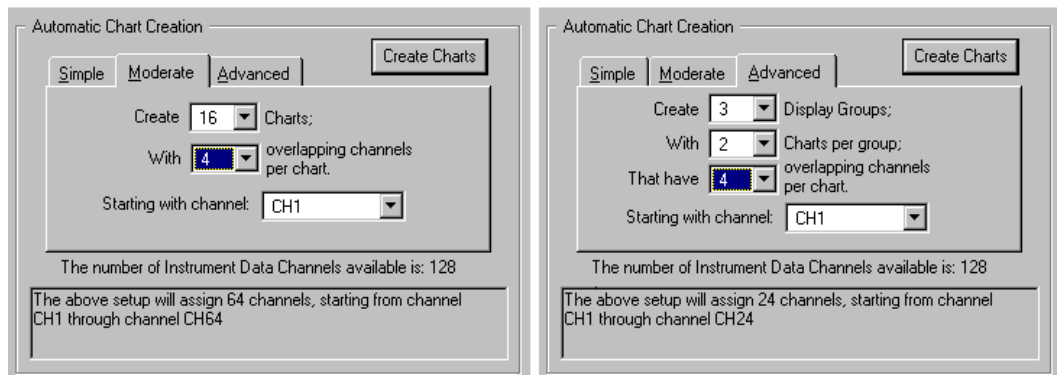

Dialog Boxes for Moderate and Advanced Modes of Automatic Chart Creation

It is a simple task to create a chart display configuration using the automatic method. The following steps apply to this feature of *Chart Setup Wizard*.

Note: If PostView locates a display configuration file, *Chart Setup Wizard* will not be activated.

1. From the *Chart Setup Wizard* window, select the desired mode (Simple, Moderate, or Advanced).

Note: Selecting *Manual Chart Creation, Create Charts* bypasses the *Chart Setup Wizard* and enters a manual editing mode. This option makes use of PostView's Display Configuration feature discussed in the following section, *Display Configuration*.

2. Use the pull-down arrows (▼), or use the cursor and type in a new value to make selections for the number of groups, charts, and channels as applicable.
3. If you desire to start with a channel other than channel 1, use the pull-down arrow and select the desired starting channel number.
4. When your setup is complete, click on the *Create Charts* button. A percentage of completion bar will appear, followed by the PostView window.

The channels in the setup you create will appear in chart form on PostView's window. The Channels will overlap on their assigned Chart (for configurations making use of multiple channels per chart), and will be visible when the applicable Group is selected. Note that only one group of charts can be viewed at a time.

Display Configuration Setup

Note: When PostView does not find a display configuration file it automatically opens the *Chart Setup Wizard*. You can use this feature to automatically create a display configuration. You also have the option of selecting *Manual Chart Creation, Create Charts* to bypass the *Chart Setup Wizard* and enter the manual editing mode, as discussed in this section.

The Display Configuration button accesses a *Display Configuration Setup* dialog box. This box will also be displayed if:

- Manual Chart Creation, Create Charts is selected from the Wizard Chart Setup window
- You select Setup from the File pull-down menu
- You right-click on the chart region in PostView's window

Note: If multiple chart groups are present in the display configuration, the current group will be selected in the display configuration tree.

When you first click on the Display Configuration button, a *Display Configuration Setup* box appears. A display region shows the configured structure of the groups, charts, and channels. From this box you can select the number of charts to be assigned to a specific group. With the use of the mouse cursor you can also select a chart or channel for additional editing.

The rest of this section has been divided into two parts. The first pertains to editing an existing display; while the second section pertains to manually creating a display configuration from scratch, i.e., there is no existing display configuration to edit. Both methods make use of *Display Configuration Setup* dialog boxes.

Editing a Display

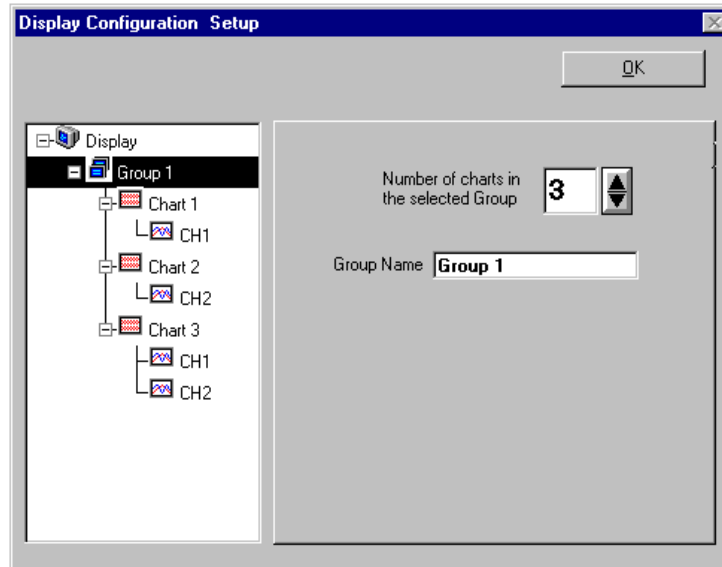

Display Configuration Setup Dialog Box with an Existing Configuration

To explain editing a configuration, we make use of an example in which assumes you want to edit Chart 1. In the following figure, Chart 1 was highlighted by clicking on it with the mouse cursor. The *Display Configuration Setup* box then changed, allowing you to see specific channel types (such as volts only) or “Show all Types,” as in the example. From this setup box you can add or delete charts and channels. You can:

- hold down the *Shift* key and use the *cursor* to select several consecutive channels for addition or deletion
- hold down the *Ctrl* key and use the *cursor* to select several non-consecutive channels for addition or deletion
- double-click on an *available channel* to add it to the selected channels
- double-click on a *selected channel* to remove it from the selected channels list

Note: When a chart contains overlapping channels and the channels share values such that their traces reside on top of each other, then the channels that are listed lower in the display list (the most recently added channels) will obscure the channels higher in the list (those which were added first).

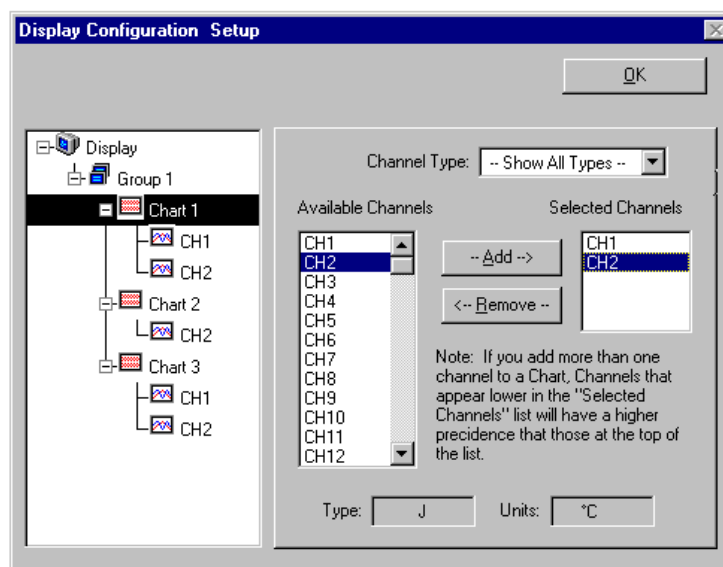

Adding Channel 2 to Chart 1

Another variation of the Display Configuration Setup box appears when you highlight a channel. In the following figure, Channel 1 (of Chart 1, Group 1) was selected, resulting in a new screen image. From this screen you can edit the channel setup.

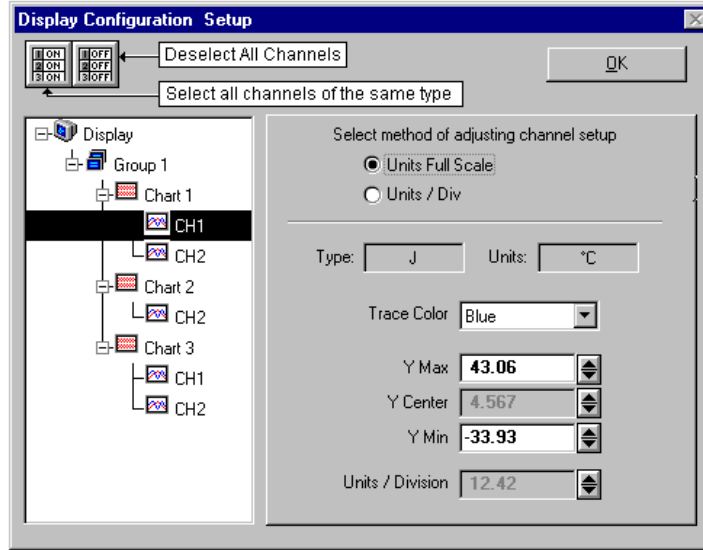

Adjusting Channel Setup for Channel 1

PostView channels can be set for either of two modes: Units Full Scale or, Units/Div. The mode is selected by radio button. Mode descriptions are as follows:

Units Full Scale. When Units Full Scale is selected, as depicted in the above figure, you can alter Y Max and Y Min. These are the upper and lower limits of the Channel as they will appear on the chart when the channel is selected. When you change either parameter, Y Center and Units/Division are automatically adjusted. You can not directly adjust Y Center or Units/Division while “Units Full Scale” is selected. You can change Y Max and Y Min by using the up and down arrows, or by highlighting the existing value, typing in the new value, the pressing “Enter” on your PC keyboard.

Note: If the window size is changed, a chart operating in the Units Full Scale mode will maintain its *full scale* setting across the chart.

Units/Div. When Units/Div. is selected you can alter Y Center and Units/Div. Y Center is the centerline value of the chart when the channel is selected. Units/Div. is the vertical value of on chart grid increment. When you change Y Center or Units/Div. Y Max and Y Min are automatically adjusted. You can not directly adjust Y Max or Y Min while “Units/Div.” Is selected. You can change Y Center and Units/Div. by using the up and down arrows, or by highlighting the existing value, typing in the new value, the pressing “Enter” on your PC keyboard.

Note: If the window size is changed, a chart operating in the Units/Div. Mode will maintain its *units per division scale* setting across the chart.

Manually Creating a Display

Note: This method of creating a display can only be accessed from the *Chart Setup Wizard*. It cannot be accessed if PostView is using an existing display configuration file.

Unlike editing a display, as just described, this method involves creating a display from scratch. If you plan to have a chart setup which is not weighted evenly, i.e., different numbers of channels per chart and different numbers of charts per group, you may want to manually create your chart display in this manner. This method can only be arrived at from the *Chart Setup Wizard* by selecting *Manual Chart Creation, Create Charts*. This bypasses the *Chart Setup Wizard* and enters the manual editing mode, discussed. Although this method is referred to as “manual,” it still contains automatic elements, such as *Automatically Add Groups to the Setup*.

Perform the following steps to manually create your chart display.

1. From the *Chart Setup Wizard* window, select *Manual Chart Creation, Create Charts*. This bypasses the *Chart Setup Wizard* and enters the manual editing mode.

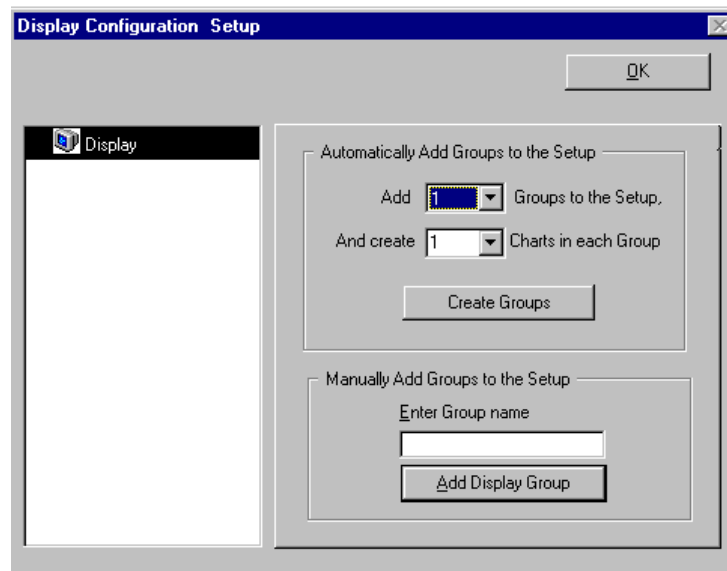

Display Configuration Setup, Initial Screen During Manual Creation

2. Perform (2a) or (2b) as appropriate to your application.

(2a) *Automatically add groups to the setup.* Enter the number of groups and charts desired by using the cursor and typing in the value, or by using the pull-down arrows (▼) and making the appropriate selections; then click on the Create Groups button.

(2b) *Manually add groups to the setup.* Type in the name of the chart group; then click on the Add Display Group button.

The Display Configuration Setup screen changes to show chart groups, and the number of charts for the selected (black highlighted) chart group (see following figure). From this screen you can change the number of charts in a group, as well as change the group name.

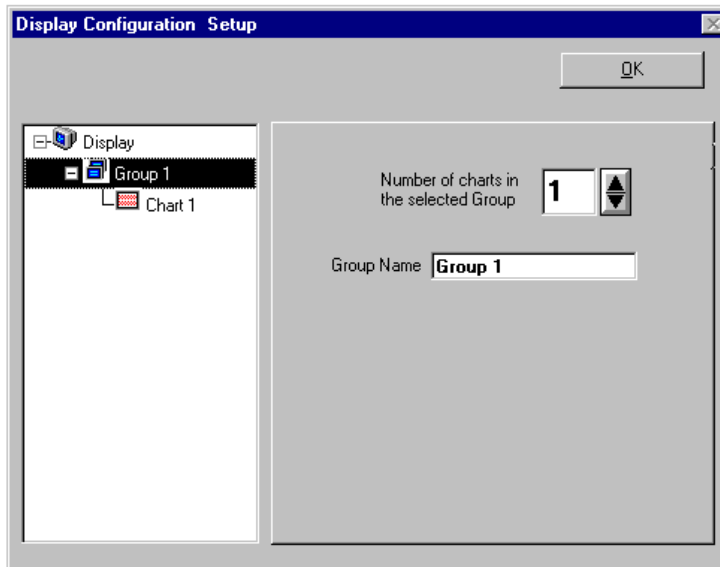

Adding a Chart to Group 1

3. Change the number of charts per group if desired.
4. Change the group name if desired.
5. Click on a group to see the chart(s) assigned to the group. In the above example there is one group with one chart.
6. Click on a chart to assign channels to the chart. A screen similar to the following will appear.

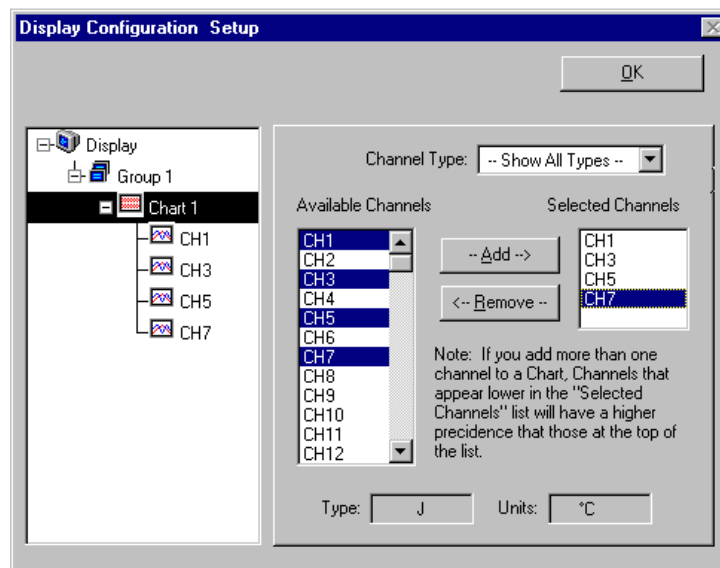

Assigning Channels to Chart 1 of Group 1

7. Choose channels for the selected chart. You can select up to 4 overlapping channels per chart. There are four methods of adding channels. These are as follows:
 - Highlight an available channel using the cursor and left-hand mouse button; then click the Add button. Repeat for each channel to be added.
 - Double-click on the channel (in the available channels list to add; in the selected channels list to remove)
 - Hold down the keyboard's *Shift Key* and use the left-hand mouse button to select a block of consecutive available channels (up to 4); then click the Add button. Example: CH3, CH4, CH5, CH6.
 - Hold down the keyboard's *Ctrl* button and use the left-hand mouse button to select up to 4 available channels (these can be non-consecutive); then click the Add button. Example: CH1, CH3, CH5, CH7, as in the previous figure.

Note: You can remove channels by highlighting a channel(s) in the Select Channels box, and then clicking on the Remove button. In the previous figure, CH7 (in the select box) is highlighted. Clicking the Remove button would delete that channel from Chart1.

Note: When a chart contains overlapping channels and the channels share values such that their traces reside on top of each other, then the channels that are listed lower in the display list (the most recently added channels) will obscure the channels higher in the list (those which were added first).

8. In the display area (on the left-hand side of the screen) click on a channel to check the channel's configuration and to re-configure the channel, if desired. The *Display Configuration Setup* Window will appear similar to that in the following figure.

This screen contains two “radio buttons” for selecting the method of adjusting the display mode and channel setup. It is the same screen that was discussed in the sub-section, *Editing an Existing Display Configuration*. From this screen you need to choose *Units Full Scale* or *Units/Div.*

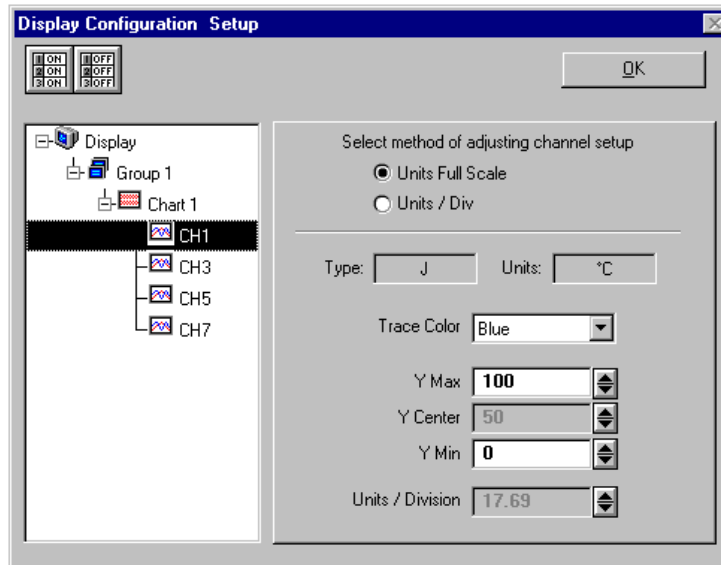

Adjusting Channel Setup for Channel 1

Units Full Scale. When Units Full Scale is selected, as depicted in the above figure, you can alter Y Max and Y Min. These are the upper and lower limits of the Channel as they will appear on the chart when the channel is selected. When you change either parameter, Y Center and Units/Division are automatically adjusted. You can not directly adjust Y Center or Units/Division while “Units Full Scale” is selected. You can change Y Max and Y Min by using the up and down arrows, or by highlighting the existing value, typing in the new value, the pressing “Enter” on your PC keyboard.

Note: If the window size is changed, a chart operating in the Units Full Scale mode will maintain its *full scale* setting across the chart.

Units/Div. When Units/Div. is selected you can alter Y Center and Units/Div. Y Center is the centerline value of the chart when the channel is selected. Units/Div. is the vertical value of on chart grid increment. When you change Y Center or Units/Div. Y Max and Y Min are automatically adjusted. You can not directly adjust Y Max or Y Min while “Units/Div.” Is selected. You can change Y Center and Units/Div. by using the up and down arrows, or by highlighting the existing value, typing in the new value, the pressing “Enter” on your PC keyboard.

The Channels will overlap on their assigned Chart and will be visible when the applicable Group is selected. Note that only one group of charts can be viewed at a time.

Note: If the window size is changed, a chart operating in the Units/Div. Mode will maintain its *units per division scale* setting across the chart.

PostView Timebase

PostView automatically detects the data file's timebase and typically displays the information in hours/minutes/seconds/tenths (00:00:00.0 format) along the X-axis at the bottom of the PostView window. PostView automatically displays milliseconds (ms) or micro-seconds (μ s) when applicable to acquisition programs which make use of such time scales. No user action is involved in regard to the timebase display.

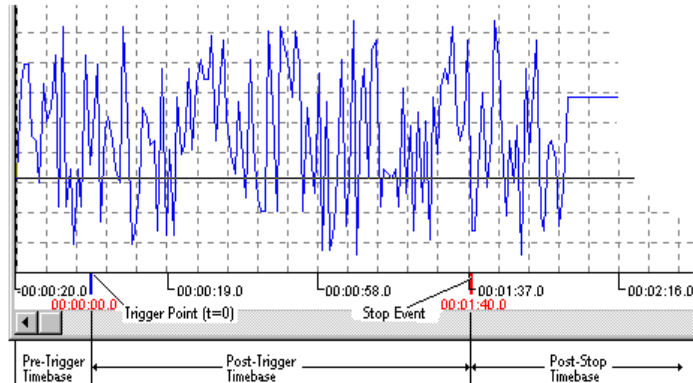

Example of a PostView Timebase

Note: For many data acquisition programs, the trigger point ($t = 0$) need not be the first point in the data file.

It is possible for the data acquisition program to create files containing multiple timebases, pre-trigger, post-trigger, and post-stop data. PostView accommodates all these features, as shown in the previous example taken from the ChartView data acquisition program.

- If pre-trigger scans are available, they will be shown prior to the trigger point and labeled with negative time numbers.
- If post-stop data is available (scans collected after the Stop Event), they are displayed after the Stop Event marker.
- If a dual timebase was used when collecting the data, PostView will show a discontinuity in the time axis when the timebase changes. When a dual timebase is used, the post-trigger scans are collected at one frequency while the pre-trigger and post-stop scans are collected at another.

Note: Some timebase aspects may differ, depending on the actual data acquisition program used. Refer to PostView's Help file for timebase information relating to specific data acquisition programs.

Data File Accessibility

PostView can access data files from the acquisition program at any time, even during the acquisition. If PostView reaches the end of a file while the acquisition file is still collecting data, PostView will automatically display the new data as it becomes available.

Note: For the fastest display of waveforms, select binary data storage (.iob extensions) in the acquisition program.

Note: Some data file aspects may differ, depending on the actual data acquisition program used. Refer to PostView's Help file for timebase information relating to specific data acquisition programs.



Notes

Introduction	157
Calibration Setup	157
Calibration Properties.....	157
Calibration Protection.....	158
ScanCal Main Window	159
Inventory Display Area.....	160
Instructions Area.....	160
File Menu Items.....	161
Instrument Menu Items.....	162
Calibrate Menu Items.....	163

Introduction

Prior to shipment, each TempScan/1100, MultiScan/1200, Exp/10A, and Exp/11A unit, as well as each TempScan/1100 and MultiScan/1200 scanning card, is calibrated. Depending on your operating guidelines, your equipment will require periodic calibration to ensure accuracy at all times. The industry standard for this calibration is once every six months.

Calibration can be performed via the traditional manual method or via a software-automated method. Manual calibration is supported by operating in *Calibration Mode*, in which a specific set of commands is provided. Meanwhile, software-automated calibration is provided by using ScanCal, which is included with the installation of TempView.

Note: Using ScanCal is not essential. But if you have access to a PC with Windows 3.X or Windows 95, we strongly suggest using this application.

The following text discusses the *software-automated method* of calibration using ScanCal. For more information on the traditional manual method of calibration, see chapter *System Calibration*.

Calibration Setup

Calibration Properties

For proper results, the TempScan/1100 or MultiScan/1200 master chassis and each scanning card must be calibrated separately. The master chassis contains an on-board battery-backed-up NV-RAM (Non-Volatile Random-Access Memory) and each card contains an on-board EEPROM (Electrically Erasable Programmable Read-Only Memory) for saving calibration constants, allowing for card-swapping within a system, card-swapping between systems, as well as system expansion. Calibration relates to the master chassis and scanning cards as follows:

- **Master Chassis:** Calibrated for channel offset and channel gain only.
- **Option Cards:** Calibrated for channel offset, channel gain, and cold junction sensor offset (if thermocouples are used).

Calibration Protection

The chassis calibration constants and the calibration password are stored by the TempScan/1100 or MultiScan/1200 in Non-Volatile RAM (NV-RAM). The password is a safety feature used to prevent unauthorized personnel from entering *Calibration Mode* and altering the calibration constants.

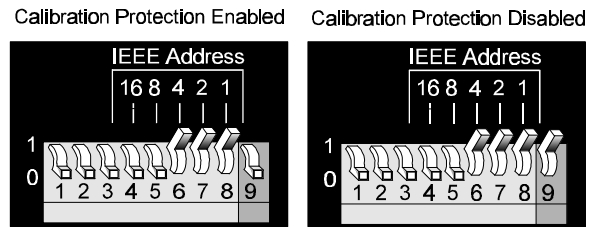

Calibration Protection Settings - Microswitch 9

As a safeguard, the calibration password and chassis calibration constants are hardware protected. This protection is enabled by setting the microswitch 9 to the down (0) position on the rear panel DIP switch. This is the default factory setting and should remain in this position unless purposely attempting to change the password or chassis constants.

If it is necessary to change the calibration password via the *Change Calibration Keyword (*K)* command, or to recalibrate the chassis, this hardware write protection can be disabled by setting microswitch 9 to the up (1) position. For more information on calibration, see chapter *System Calibration*.

CAUTION



To ensure accurate measurements, calibration must only be performed by authorized personnel.

CAUTION



Do not perform calibration until after your TempScan/1100 or MultiScan/1200 system has been powered on for at least one hour.

CAUTION



To ensure the integrity of the chassis calibration constants, verify that DIP microswitch 9 is set in the down (0) position unless you are attempting to change the calibration password or chassis calibration constants.

CAUTION



Do not forget to set DIP microswitch 9 back to the down (0) position when calibration is complete. Otherwise, the calibration password and calibration chassis constants may be corrupted and normal operation may be disrupted.

ScanCal Main Window

Select the ScanCal option from the *TempView Program Group*, via the *Program Manager* in Windows 3.X or via the *Start Menu* in Windows 95. The *ScanCal Main Window* will appear.

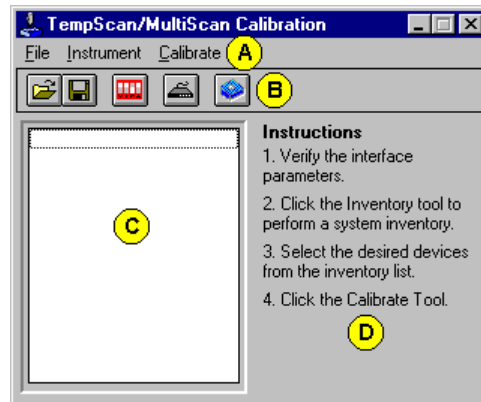

Before Instruction Step 2

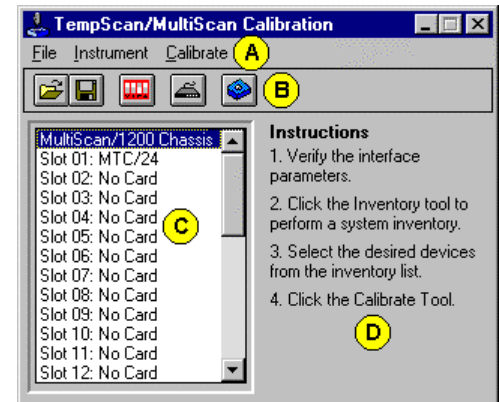

After Instruction Step 2

Items labelled by the lettered circles (A to D) are identified in the table below.

ScanCal Main Window Areas

ScanCal Main Window Areas			
(X)	Window Area	(X)	Window Area
(A)	Pull-Down Menus	(C)	Inventory Display Area
(B)	Toolbar Menu	(D)	Instructions Area

The *ScanCal Main Window* consists of one pull-down menu bar (A), one toolbar menu (B), and the following two areas: The *Inventory Display* area (C) and the *Instructions* area (D).

Located at the top of the *ScanCal Main Window*, the pull-down menu bar (A) includes the following three menus:

- *File*
- *Instrument*
- *Calibrate*

Located below the pull-down menu bar, the toolbar menu (B) includes the five toolbar buttons listed and identified in the table.

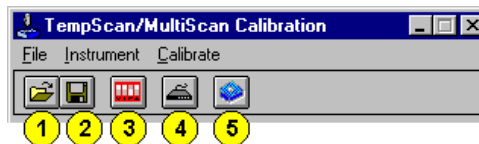

Items labelled by the numbered circles (1 to 5) are identified in the table below.
Note: When the cursor is placed over any toolbar button (1 to 5), a pop-up label appears.

ScanCal Toolbar Menu Items

ScanCal Toolbar Menu Items					
Button	(#)	Tool Name	Button	(#)	Tool Name
	(1)	Open Interface Parameters (File Pull-Down Menu)		(4)	Take Inventory (Instr. System) (Instrument Pull-Down Menu)
	(2)	Save Interface Parameters (File Pull-Down Menu)		(5)	Calibrate Selected Devices (Calibrate Pull-Down Menu)
	(3)	Setup Interface Parameters (Instrument Pull-Down Menu)			

These *ScanCal Main Window* components are discussed in further detail in the following text.

Inventory Display Area

The *Inventory Display* area (C) of the *ScanCal Main Window* displays the list of connected equipment available for calibration, including the TempScan/1100 or MultiScan/1200 master chassis and any scanning cards. With the master chassis connected, this area is activated via the *Instrument > Take Inventory* menu item, or via the corresponding *Inventory Instrument System* button (4). Before this area is activated, the list is blank.

Instructions Area

The *Instructions* area (D) of the *ScanCal Main Window* displays the four-step procedure involved in performing the software-automated calibration. The steps are repeated and explained below, illustrated with the proper pull-down menu item and corresponding toolbar button.

Note: Remember to disable the calibration protection by setting the rear panel DIP microswitch 9 to the up (I) position.

Step 1: Verify the Interface Parameters



(3)

Activate the *Interface Parameters* dialog box via the *Instrument > Setup Interface Parameters* menu item, or via the corresponding *Setup Interface Parameters* button (3). This dialog box allows you to select and setup the communication interface used for your TempScan/1100 or MultiScan/1200 system.

You can toggle between the *IEEE 488 Port* and *Serial Port (RS-232)* versions of the *Interface Parameters* dialog box by selecting the desired interface in the top pull-down list. In the bottom half of the dialog box, the *Rear Panel Switch Settings* area automatically updates to correspond to the selected parameters. Click the *Verify* box to make sure the settings are correct.

Step 2: Click the Inventory Tool to Perform a System Inventory



(4)

Generate a list of connected equipment available for calibration, including the TempScan/1100 or MultiScan/1200 master chassis and any scanning cards, via the *Instrument > Take Inventory* menu item, or via the corresponding *Inventory Instrument System* button (4). The generated list appears in the *Inventory Display* area (C) of the *ScanCal Main Window*.

Step 3: Select the Desired Devices from the Inventory List

Select the devices to be calibrated from the *Inventory Display* area (C) of the *ScanCal Main Window*.

Step 4: Click the Calibrate Tool



(5)

Initiate the automatic calibration process via the *Calibrate > Calibrate Selected Devices* menu item, or via the corresponding *Calibrate Selected Devices* button (5). Be prepared to supply the appropriate password as prompted by ScanCal. The ScanCal program automatically steps you through the calibration process.

Note: Clicking the *Skip This Step* button of the *Calibration Procedure* dialog box causes the automatic calibration process to skip to the next step. The current calibration settings will not change. This feature is useful for stepping through the process before performing the actual calibration.

Post-Calibration



(2)

After you complete the four-step procedure, you can save the interface parameters via the *File > Save Interface Parameters* menu item, or via the corresponding *Save Interface Parameters* button (2).

You can also save the calibration constants via the *Calibrate > Upload Cal Constants* menu item. There is no toolbar button corresponding to this menu item.

Note: Remember to re-enable the calibration protection by resetting the rear panel DIP microswitch 9 to the down (O) position.

File Menu Items

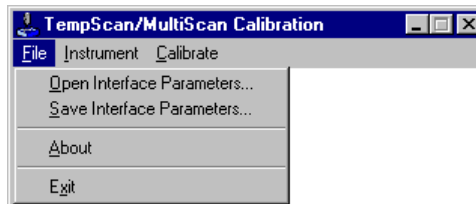

File Menu Items

Open Interface Parameters



(1)

Allows you to open an interface parameter file. The *Open Interface Parameter File* dialog box appears when this menu item is selected.

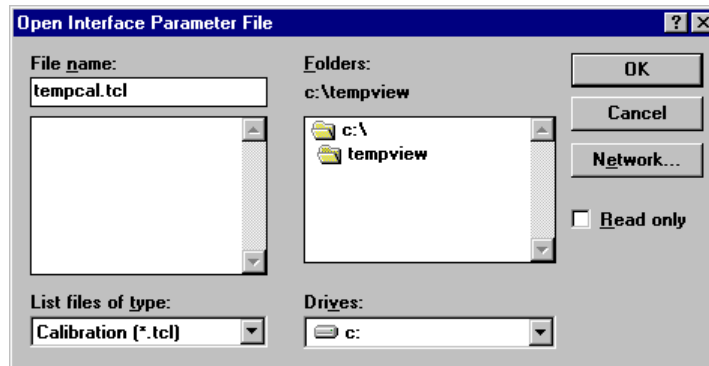

Note: The Save As dialog box (File > Save Interface Parameters...) looks similar to the *Open Interface Parameter File* dialog box.

*Open Interface Parameter File Dialog Box
(File > Open Interface Parameters)*

Save Interface Parameters



(2)

Allows you to save an interface parameter file. The *Save As* dialog box appears when this menu item is selected.

About

Provides the ScanCal software version in the *About TempScan/MultiScan Calibration* dialog box.

Exit

Exits the ScanCal program.

Instrument Menu Items

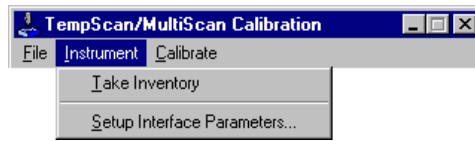

Instrument Menu Items

Take Inventory (or Inventory Instrument System)



(4)

Generates a list of connected equipment available for calibration, including the TempScan/1100 or MultiScan/1200 master chassis and any scanning cards. The *ScanCal* dialog box prompts you to check that the equipment is connected and powered up. When the equipment is properly connected and powered up, the generated list appears in the *Inventory Display* area (C) of the *ScanCal Main Window*.

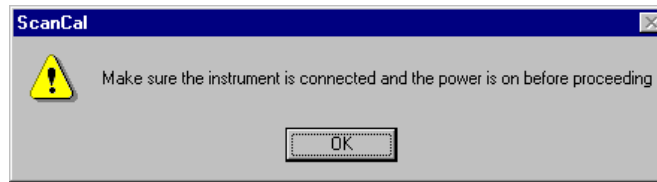

ScanCal Dialog Box
(Instrument > Take Inventory (Instrument System))

This menu item is involved in *Step 2* of the *Instructions* area (D) in the *ScanCal Main Window*.

Setup Interface Parameters



(3)

Allows you to select and setup the communication interface used for your TempScan/1100 or MultiScan/1200 system. The *Interface Parameters* dialog box appears when this menu item is selected.

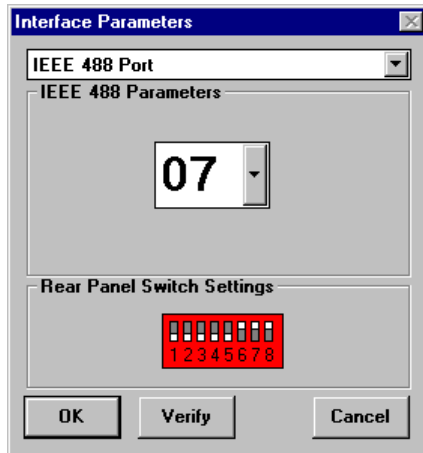

"IEEE 488 Port" selected

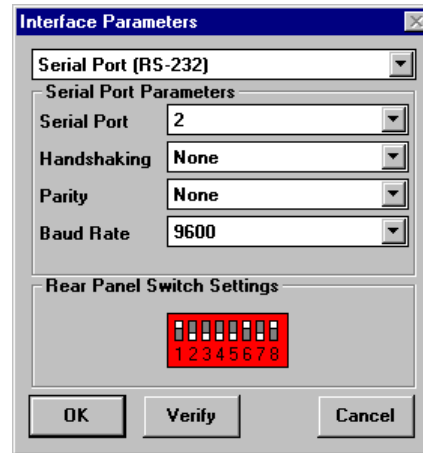

"Serial Port (RS-232)" selected

Interface Parameters Dialog Box
(Instrument > Setup Interface Parameters)

This menu item is involved in *Step 1* of the *Instructions* area (D) in the *ScanCal Main Window*.

Calibrate Menu Items

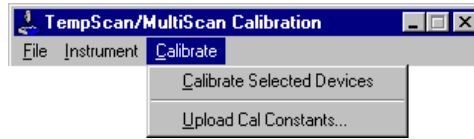

Calibrate Menu Items

Calibrate Selected Devices



(5)

Initiates the automatic calibration process. The *Password* dialog box prompts you to supply the appropriate password. When the password is accepted upon clicking OK, the *Calibration Procedure* dialog box appears. The ScanCal program automatically steps you through the calibration process.

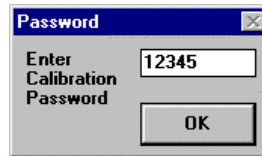

*Password Dialog Box
(Calibrate > Calibrate Selected Devices)*

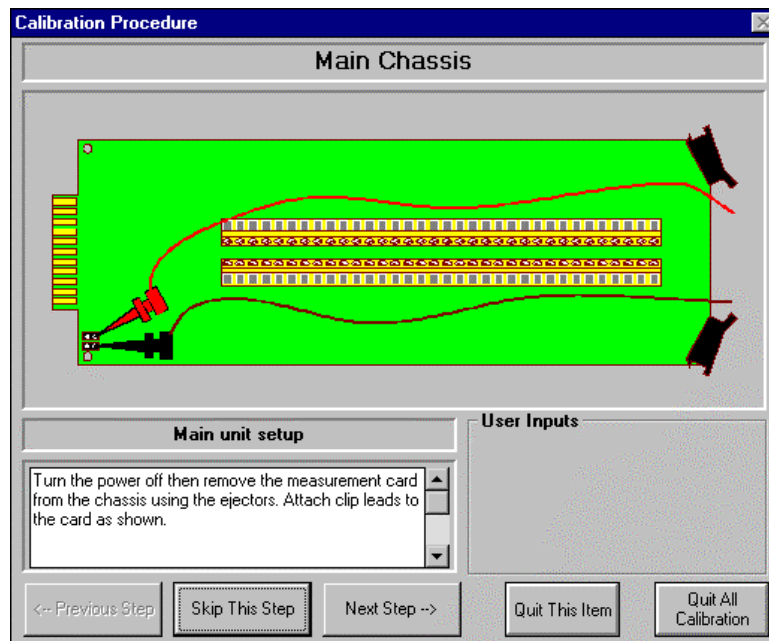

*Calibration Procedure Dialog Box
(Calibrate > Calibrate Selected Devices > Click OK)*

Note: Clicking the *Skip This Step* button of the *Calibration Procedure* dialog box causes the automatic calibration process to skip to the next step. The current calibration settings will not change. This feature is useful for stepping through the process before performing the actual calibration.

This menu item is involved in *Step 4* of the *Instructions* area (D) in the *ScanCal Main Window*.

Upload Cal Constants

Allows you to save the calibration constants. The *Save Calibration Constants* dialog box appears when this menu item is selected.

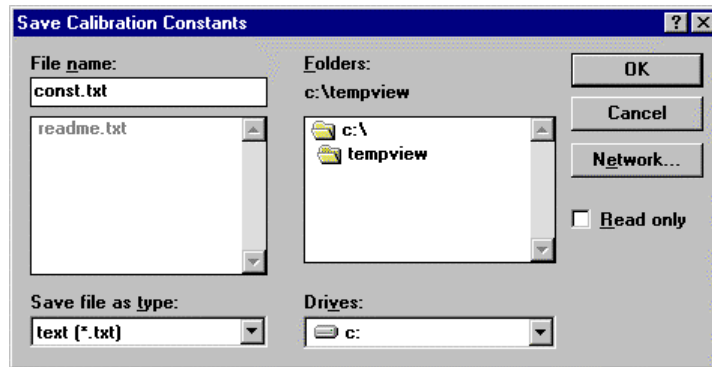

*Save Calibration Constants Dialog Box
(Calibrate > Upload Cal Constants)*

Introduction	165
Memory Allocation	166
Measuring Modes (MultiScan/1200 Only)	166
Line-Cycle Integration / High-Speed Multi-Channel Mode.....	167
Single-Channel High-Speed Burst Mode.....	169
Required Configuration	170
Channel Configuration.....	171
Scan Configuration.....	173
Acquisition Configuration.....	177
Trigger Configuration.....	180
Additional Configuration	182
Alarm Configuration.....	183
Stamp Configuration.....	186
Data Format Configuration.....	190
Power-Up Configuration.....	196

Introduction

The primary function of the TempScan/1100 or MultiScan/1200 system is to scan and digitize transducer signals, typically thermocouples. Most of the system features are programmable, allowing you to change settings and configurations from the controlling computer.

The API command set of the TempScan/1100 or MultiScan/1200 unit provides access to these programmable features. Issuing commands to the unit changes its internal state and its operating configuration. Most operating states have a default value. If no commands are sent to alter its original state, the default value will be used. Sending commands to the unit is necessary only if the default values are not desired.

For experts who prefer to program, the following text discusses the configuration of the TempScan/1100 and MultiScan/1200 systems without the use of ChartView or TempView. ChartView and TempView are Windows-based setup and acquisition applications, either of which is included with your TempScan/1100 or MultiScan/1200 package and provides an easy-to-use alternative to programming. For more information on ChartView, see chapter *ChartView*. For more information on TempView, see chapter *TempView*.

Memory Allocation

Each TempScan/1100 and MultiScan/1200 unit comes equipped with standard 256 KB memory. Three memory options are provided for expanding the standard 256 KB memory: 1 MB (TempMEM1 or MultiMEM1), 4 MB (TempMEM4 or MultiMEM4), or 8 MB (TempMEM8 or MultiMEM8).

Whichever option is added, the TempScan/1100 or MultiScan/1200 unit will automatically allocate its memory for optimal use according to its current configuration. TempScan/1100 or MultiScan/1200 memory is broken into the following two main regions:

- **High/Low/Last (HLL) Registers** (only configured channels)
- **Acquisition Buffer**

When channels are configured, the TempScan/1100 or MultiScan/1200 calculates how much memory will be needed for the High/Low/Last (HLL) Registers. The memory allocated to the HLL Registers would be the following value – **(Number of channels) x 20 bytes** – while the remaining memory would be allocated to the Acquisition Buffer. For example, if the memory option is 256K (**262144 bytes**) and the number of configured channels is 96, then the amount allocated to the Acquisition Buffer would be:

```
262144 bytes Total Memory (256 KB)
- 1920 bytes High/Low/Last (96 x 20)
-----
260224 bytes Acquisition Buffer Allocation (254.125 KB)
```

Measuring Modes (MultiScan/1200 Only)

The operation of the MultiScan/1200 unit involves two basic internal measuring modes, as follows:

- **Line-Cycle Integration / High-Speed Multi-Channel (or Default) Mode.** In the line-cycle integration / high-speed multi-channel mode, the MultiScan/1200 samples channel data at 1.92 kHz or once every 520.83 μ s. You can select the number of samples over which to average in order to accomplish noise filtering.
- **Single-Channel High-Speed Burst Mode.** In the single-channel burst mode, the MultiScan/1200 collects data in user-defined multiples of 256 samples at a user-defined sampling frequency between 38.5 Hz and 20.0 kHz.

The following commands are provided to setup the MultiScan/1200 for a given measuring mode.

- **M#mode:** Select the measuring mode. The factory default is line cycle integration / high-speed multi-channel mode.
- **W#wt:** Select the number of samples over which to average for each channel. This is valid only in line cycle integration / high-speed multi-channel mode. The factory default is 32 samples.
- **F#freq:** Select the burst mode frequency. This is valid only in single-channel high-speed burst mode. The factory default is 20 kHz (or 20000 Hz).
- **Y0,post,0:** In line-cycle integration / high-speed multi-channel mode, select the number of *Post-Trigger* scans.

In single-channel high-speed burst mode, select the number of 256-sample blocks to acquire. The number must be a power of 2.

- **U16:** Query the measuring mode parameters **M#**, **W#**, **F#**, and/or **Y** to verify your selections.

For more information on the above commands, see chapter *API Command Reference*.

Note: (1) For DC voltage and temperature, the term *averaging* implies obtaining the average measurement over the specified number of samples. (2) For AC voltage, the term *averaging* implies computing the RMS (Root Mean Square) value over the specified number of samples.

To Compute the MultiScan/1200 Scan Interval

To compute the time interval for the MultiScan/1200 to acquire one scan, use the following formulas:

- **For a 60-Hz Line Cycle:** Scan Interval equals:

$$IS-m = Cv \times (Wv + 12) \times R1$$

- **For a 50-Hz Line Cycle:** Scan Interval equals:

$$IS-m = Cv \times (Wv + 12) \times R2$$

Where:

IS-m = Scan Interval for the MultiScan/1200, milliseconds.

Cv = Channels, variable number of configured channels in the scan.

wv = Sampling Weight, variable number of samples per channel.

R1 = Sampling Rate, constant of 0.52083 milliseconds per sample for a 60-Hz line cycle.

R2 = Sampling Rate, constant of 0.62500 milliseconds per sample for a 50-Hz line cycle.

To compute the time interval for the TempScan/1100 to acquire one scan, see section *To Compute the TempScan/1100 Scan Interval*, on page 175.

Line-Cycle Integration / High-Speed Multi-Channel Mode

The ability of the MultiScan/1200 unit to sample and average 32 measurements per line cycle enables it to reject noise resulting from AC line pickup, hence making it useful for high-accuracy applications. When in line-cycle integration / high-speed multi-channel mode with the default weight of 32 samples per channel, the unit can provide AC voltage, DC voltage, and thermocouple readings at a rate of up to 44 channels per second. Further noise filtering is available with averaging over 2, 4, or 8 line cycles (at 32 samples per line cycle) by selecting a weight of 64, 128, or 256 samples, respectively.

Sampling Weight Options		
Weight (wt)	Line Cycles (32 Measurements Each)	Maximum Number of Channels
1, 2, 4, 8, 16, 32	1	744
64	2	431
128	4	234
256	8	122

CAUTION



Due to hardware constraints, weights greater than 32 (default) limit the number of channels which can be active in an acquisition.

If noise resulting from AC line pickup is not a concern, you can program the MultiScan/1200 unit to average 1, 2, 4, 8, or 16 samples per channel for faster scanning throughput. For example, using the scan interval formula for a 60-Hz line cycle, if the unit is configured to take 1 sample per channel, it can scan 147 adjacent channels per second. This means a fully-expanded MultiScan/1200 system could scan all of its 744 channels every 5 seconds.

Note: The MultiScan/1200 unit only supports the measurement of AC voltages where the frequency of the input signal is an integer multiple of the AC line cycle. Consequently, sampling weights less than 32 can yield incorrect results. In order to compute an accurate V_{rms} value, you must program a frequency which will yield a sufficient even integer number of samples per line cycle.

To Enable the Default Mode

To enable line-cycle integration / high-speed multi-channel mode, issue the following commands:

- **M#mode:** Select line-cycle integration / high-speed multi-channel mode, where **mode** is 0.
- **W#wt:** Select the number of samples over which to average, where **wt** is the one of the following weights: 1, 2, 4, 8, 16, 32 (default), 64, 128, and 256.
- **Y0,post,0:** Select the number **post** of *Post-Trigger* scans.
- **Cchans,type:** Select the channel number or range, and the scanning-card channel type(s).
- **Tstart,stop,0,0:** Set the *Trigger* (trigger start event) to the software *Trigger On* (@) command, where **start** is 1; and set the *Stop* (trigger stop event) to Count, where **stop** is 8. The *Set Counts* (Y) command is made valid when the *Stop* is set to Count.
- @: Start the acquisition.

For more information on the above commands, see chapter *API Command Reference*.

Common Mode Voltage Inaccuracies

Inaccuracies can result if common mode voltages on adjacent channels are widely dissimilar. This inaccuracy is due to inadequate settling time at the instrumentation amplifier when the unit is scanning between channels. To eliminate these inaccuracies, the settling time can be increased using the *Set Relay Make Time* (D#) command. For more information on this command, see chapter *API Command Reference*.

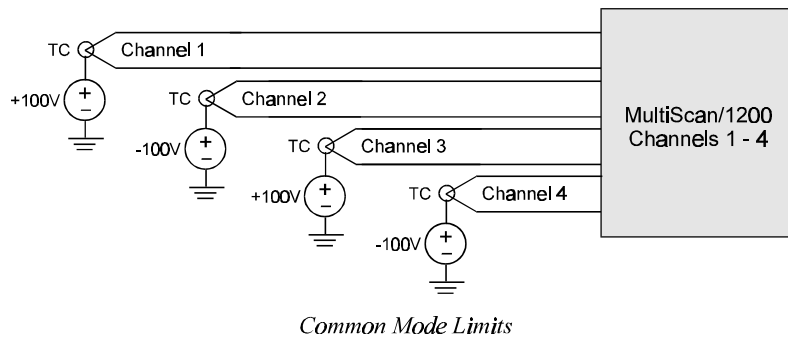

Single-Channel High-Speed Burst Mode

In single-channel high-speed burst mode, the MultiScan/1200 unit can sample and store data from 38.5 Hz to 20 kHz. When performing post-acquisition waveform analysis such as *Fast Fourier Transforms* (FFTs), the unit can return the data points to your program in a waveform. As an alternative, the unit can provide a true RMS (Root Mean Square) value of the equivalent AC voltage.

Due to the high sampling rates achievable in single-channel high-speed burst mode, the posting of the High/Low/Last (HLL) Registers and the alarms is disabled. Also, for the same reason, the *Trigger* (trigger start event) can only be set to the software *Trigger On* (@) command, the *Stop* (trigger stop event) can only be set to Count (validating the *Set Counts* (Y) command), and the following items are not permitted: *Pre-Trigger*, *Post-Stop* count, scan time stamping, and scan alarm stamping. For more information, see command *Set Trigger Configuration* (T) in the chapter *API Command Reference*.

In single-channel high-speed burst mode, the MultiScan/1200 internally collects the samples for the selected channel in 256-sample blocks. However, this externally appears the same as 256-channel scans in the line-cycle integration / high-speed multi-channel mode. That is, when you program the number of 256-sample blocks in the *Post-Trigger* count parameter **post** of the *Set Counts* (Y) command, you will retrieve the data from the MultiScan/1200 unit as "*Post-Trigger* count" scans of 256 samples. For more information, see command *Set Counts* (Y) in the chapter *API Command Reference*.

For AC voltage measurements in burst mode, the RMS value can be retrieved with the **U17** query command upon completion of the acquisition.

Note: The single-channel high-speed burst mode is a one-shot operation, since it collects the specified number of samples and stops. It is not continuous, and does not allow memory overflow and wrap-around. The maximum amount of samples which can be taken is dictated by the amount of memory available. See command *Set Counts* (Y) in the chapter *API Command Reference*.

Note: The MultiScan/1200 unit only supports the measurement of AC voltages where the frequency of the input signal is an integer multiple of the AC line cycle. Consequently, sampling weights less than 32 can yield incorrect results. In order to compute an accurate *V_{rms}* value, you must program a frequency which will yield a sufficient even integer number of samples per line cycle.

To Enable the Burst Mode

To enable single-channel high-speed burst mode, issue the following commands:

- **M#mode**: Select single-channel high-speed burst mode, where **mode** is 1.
- **F#freq**: Select the burst mode sampling frequency, where **freq** is a real number between 38.5 and 20000 Hz (default).
- **Y0,post,0**: Select the number **post** of 256-sample blocks to acquire, where **post** is limited by the amount of memory available.
- **Cchans,type**: Select the channel number and the scanning-card channel type.
- **Tstart,stop,0,0**: Set the *Trigger* (trigger start event) to the software *Trigger On* (@) command, where **start** is 1; and set the *Stop* (trigger stop event) to Count, where **stop** is 8. The *Set Counts* (Y) command is made valid when the *Stop* is set to Count.
- **@**: Start the acquisition.

For more information on the above commands, see chapter *API Command Reference*.

Required Configuration

Although most of the user-defined configuration states have associated defaults, the TempScan/1100 or MultiScan/1200 does not scan its channels on the initial power-up activation. Before scans can begin, the following required configurations must be performed:

- *Configuration of the desired channels.* See command *Channel Configuration (C)*.
- *Configuration of the scan.* See commands *Channel Configuration (C)* and *Set Scan Interval (I)*.
- *Configuration of the acquisition.* See command *Set Counts (Y)*.
- *Configuration of the Trigger and Stop events.* See command *Set Trigger Configuration (T)*.

After these steps are completed and scanning begins, the alarms and the High/Low/Last Registers are updated at the programmed scan rate, and the scans are placed in the Acquisition Buffer.

Example 12a. Required Configurations

```
(1) PRINT#1,"OUTPUT07; C1-4,1X"  
(2) PRINT#1,"OUTPUT07;I00:01:00.0,00:00:01.0X"  
(3) PRINT#1,"OUTPUT07;Y100,1000,0X"  
(4) PRINT#1,"OUTPUT07;T1,8,0,0X"  
(5) PRINT#1,"OUTPUT07;@X"  
  
(6) PRINT#1,"OUTPUT07 U4X"  
(7) PRINT#1,"ENTER07"  
(8) INPUT A$
```

The above command lines illustrates all of the required configurations:

- **Line 1:** Configure channels 1 to 4 with Type J thermocouples.
- **Line 2:** Configure the *normal* scan interval to 1 minute and the *acquisition* scan interval to 1 second.
- **Line 3:** Set the *Pre-Trigger* scan count to 100 and the *Post-Trigger* scan count to 1000.
- **Line 4:** Configure the *Trigger* (trigger start event) to the software *Trigger On (@)* command and the *Stop* (trigger stop event) to the *Post-Trigger* Count. The front panel *TRIGGER* LED indicator should flash.
- **Line 5:** Trigger the acquisition. Acquisition scans should now be collected until 1000 *Post-Trigger* scans have been collected. The front panel *TRIGGER* LED indicator should be on.

Querying the High/Low/Last Registers shows the temperature values for the configured channels.

- **Line 6:** Query HLL registers for the configured channels.
- **Line 7:** Get the response.
- **Line 8:** The screen will show the temperature data for the four channels.

Channel Configuration

The TempScan/1100 or MultiScan/1200 unit performs several sophisticated calculations on the raw voltage before supplying it to the controlling computer. To perform such calculations, the unit must know the channel transducer type, and configuring a channel is the process of describing the channel transducer to the TempScan/1100 or MultiScan/1200 unit. Consequently, the configured channel becomes part of the channel scan.

The TempScan/1100 system, including any connected Exp/10A and Exp/11A expansion units, accepts any combination of three kinds of scanning cards. Meanwhile, the MultiScan/1200 system, including any connected Exp/10A and Exp/11A expansion units, accepts any combination of two kinds of scanning cards.

For the TempScan/1100 unit or the expanded TempScan/1100 system, the three scanning cards are:

- **TempTC/32B:** This thermocouple (T/C) scanning card contains 32 differential input channels.
- **TempV/32B:** This volts scanning card contains 32 differential input channels.
- **TempRTD/16B:** This RTD scanning card contains 16 differential input channels.

For the MultiScan/1200 unit or the expanded MultiScan/1200 system, the two scanning cards are:

- **MTC/24:** This thermocouple/volts scanning card contains 24 differential input channels.
- **MHV/24:** This high-voltage scanning card contains 24 differential input channels.

The modularity of the TempScan/1100 or MultiScan/1200 system eliminates the need for synchronizing separate and possibly incompatible analog-to-digital (A/D) measuring instruments or boards. This is an important consideration because many temperature measurement systems require a combination of thermocouples, voltage, and RTD inputs.

The TempScan/1100 or MultiScan/1200 system is capable of sensing the scanning card type that is plugged into a slot in the master unit or in one of its connected expansion units. When configuring a channel, the configuration parameters must match the scanning card type. For example, with a TempScan/1000 system, a volts type cannot be assigned to a channel on a thermocouple scanning card, and a thermocouple type cannot be assigned to a channel on a volts scanning card. If you attempt to configure a channel number that is of the wrong type or does not exist, a channel configuration error will be logged in the Error Source Register.

Using the *Configure Channels* (C) command, the minimum channel configuration required is a channel type assigned for a single channel number or a range of channel numbers. Those channels not included in the channel scan do not have to be configured. In addition to channel type and channel number, each channel included in the channel scan can have the optional values – high alarm setpoint, low alarm setpoint, and hysteresis – associated with it. The TempScan/1100 or MultiScan/1200 alarms allow the unit to produce an internal event when the value of a channel is outside of desired limits. These alarm events can be used as a *Trigger* (trigger start event) or *Stop* (trigger stop event), or as a stimulus for TTL-level signals. For more information on channel types, see command *Configure Channels* (C).

CAUTION



The channel configuration cannot be changed while the trigger is armed or an acquisition is taking place.

Configuring TempTC/32B Thermocouple Channels (TempScan/1100 Only)

If the TempTC/32B scanning card is used, 32 differential thermocouple inputs are provided. In configuring thermocouple channels, all that is required is to assign each channel to a particular thermocouple type. Support for Type J, K, T, E, R, S, B and N (14 and 28 gauge) thermocouples are standard. The 100-mV (with and without range-error detection) types are also supported.

Configuring TempV/32B Volts Channels (TempScan/1100 Only)

If the TempV/32B scanning card is used, 32 differential voltage inputs are provided. In configuring voltage channels, all that is required is to assign each channel to a particular voltage type. Support for ± 100 mV, ± 1 V, ± 5 V, and ± 10 V ranges in DC are standard.

Configuring TempRTD/16B RTD Channels (TempScan/1100 Only)

If the TempRTD/16B scanning card is used, 16 inputs for 3-wire or 4-wire RTDs are provided. In configuring RTD channels, all that is required is to assign each channel to a particular RTD type, where channel numbers 17 through 32 on the scanning card are not used.

Configuring MTC/24 Thermocouple Channels (MultiScan/1200 Only)

If the MTC/24 scanning card is used, 24 differential thermocouple inputs are provided. In configuring thermocouple channels, all that is required is to assign each channel to a particular thermocouple type. Support for Type J, K, T, E, R, S, B and N (14 and 28 gauge) thermocouples are standard.

Configuring MTC/24 Volts Channels (MultiScan/1200 Only)

If the MTC/24 scanning card is used, 24 differential voltage inputs are provided. In configuring voltage channels, all that is required is to assign each channel to a particular voltage type. Support for ± 100 mV, ± 1 V, ± 5 V, and ± 10 V ranges in both DC and AC are standard.

Note: The above AC ranges are maximum peak-to-peak signals for AC volts. Vrms values are accurate to 70.7% of peak value.

Note: The MultiScan/1200 unit only supports the measurement of AC voltages where the frequency of the input signal is an integer multiple of the AC line cycle. Consequently, sampling weights less than 32 can yield incorrect results. In order to compute an accurate Vrms value, you must program a frequency which will yield a sufficient even integer number of samples per line cycle.

Configuring MHV/24 High-Voltage Channels (MultiScan/1200 Only)

If the MHV/24 scanning card is used, 4 differential high-voltage inputs are provided. In configuring high-voltage channels, all that is required is to assign each channel to a particular voltage type. Support for ± 2.5 V, ± 25 V, and ± 250 V ranges in both DC and AC are standard.

Note: The above AC ranges are maximum peak-to-peak signals for AC volts. Vrms values are accurate to 70.7% of peak value.

Note: The MultiScan/1200 unit only supports the measurement of AC voltages where the frequency of the input signal is an integer multiple of the AC line cycle. Consequently, sampling weights less than 32 can yield incorrect results. In order to compute an accurate Vrms value, you must program a frequency which will yield a sufficient even integer number of samples per line cycle.

Scan Configuration

Configuring the Scan

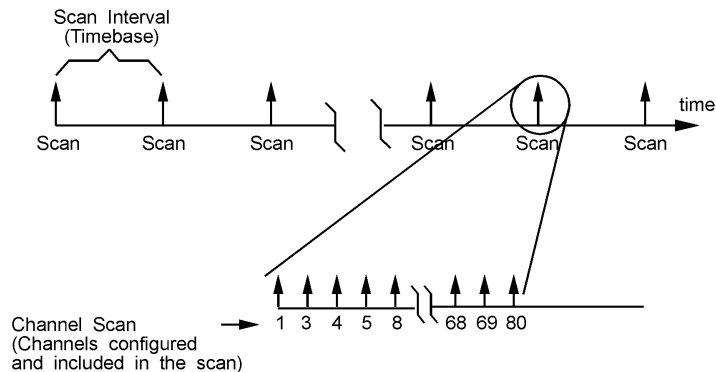

Channel Scan & Scan Interval Definitions

Although a fully-expanded TempScan/1100 or MultiScan/1200 system of 31 available scanning-card slots can provide a maximum capacity of 992 or 744 channels, respectively, only those channels configured in the channel scan are collected and available to the controlling computer. Channels are always scanned in ascending order, regardless of the sequence you input. The same configuration is used in reading channel data through the High/Low/Last Registers or the Acquisition Buffer.

Scan configuration is also accomplished using the *Configure Channels (C)* command. This command allows up to a maximum of 992 TempScan/1100 channels or 744 MultiScan/1200 channels to be assigned as individual channels or as a range of channels. The maximum number of channels can be configured in any sequence, but these channels will be ordered sequentially for the scan.

Note: TempScan/1100 or MultiScan/1200 scans cannot randomly access the selected channels.

Configuring the Scan Interval

The scan interval is the time lapse between successive scans (or the inverse of the scan frequency). Using the *Set Scan Interval (I)* command, you can program the scan interval with any duration from a 99-hour period down to as fast as the unit can run under the current channel configuration.

The TempScan/1100 or MultiScan/1200 has two distinct types of scan intervals:

- **Normal Scan Interval.** The *normal* scan interval is used when the TempScan/1100 or MultiScan/1200 unit is acquiring scans before the *Trigger* (trigger start event) has occurred, or after the *Stop* (trigger stop event) has occurred. These two scanning regions are called the *Pre-Trigger* scan and the *Post-Stop* scan, respectively.
- **Acquisition Scan Interval.** The *acquisition* scan interval is used when the TempScan/1100 or MultiScan/1200 unit is acquiring scans after the *Trigger* (trigger start event) has occurred, but before the *Stop* (trigger stop event) has occurred. This middle scanning region is called the *Post-Trigger* scan.

The *Set Scan Interval (I)* command is used to set these two types of scan intervals. For example, the following command – `I00:00:10.0,00:00:00.1` – will set the *normal scan interval* to once every 10 seconds and set the *acquisition scan interval* to once every 0.1 seconds. One useful application for having two different scan intervals is when events after the *Trigger* require faster sampling than those before the *Trigger*, such as during alarm conditions.

Fast-Mode Scan Rate (Minimum Scan Interval)

However, the scan interval can also be set to run at the *minimum scan interval*, yielding the fastest scan rate that the current system configuration will allow. This is referred to as *fast mode*. Either the *normal* or *acquisition scan interval* can be set to *fast mode*, by specifying the following scan interval – 00:00:00.0 – in the \mathbb{T} command. For example, the command – $\mathbb{T}00:00:10.0,00:00:00.0$ – will set the *normal scan interval* to once every 10 seconds and set the *acquisition scan interval* to *fast mode*. These two types of scan intervals may be queried any time via the $\mathbb{T}?$ command.

If *fast mode* is specified, the TempScan/1100 or MultiScan/1200 unit will acquire scans at the fastest rate that the current system configuration will allow. This requires some explanation since the rate at which scans are acquired, while the unit is in *fast mode*, may vary greatly depending upon the number of channels configured as well as the *disposition* of those configured channels.

Note: The High/Low/Last Registers, the alarms, and the level event (if programmed) are all updated at the maximum scan rate (or once every minimum scan interval), independent of any other timebase configuration.

Disposition of Channel Configuration (TempScan/1100 Only)

An important aspect of the TempScan/1100 channel configuration is the number of channels configured within a *channel block*. The TempScan/1100 groups its channels into channel blocks, where each channel block consists of four channels. For example, the first channel block in the TempScan/1100 system consists of channels 1 through 4; the second, channels 5 through 8; and so on.

The *disposition* of the channels refers to the density of the total channels configured within the system, or in other words, the number of channels skipped and not skipped over. The greater the density of the channel blocks, that is, the greater the number of configured channels for a given channel range, the better the sampling rate will be.

The variable in determining the minimum scan interval is the *number of non-empty 4-channel blocks*. Once you determine the number of non-empty 4-channel blocks, you can calculate the minimum scan interval using the appropriate formula for your 50-Hz or 60-Hz line cycle system.

Example Disposition of TempScan/1100 Channel Configuration					
4-Channel Block	Channels	In Use?	4-Channel Block	Channels	In Use?
1	1, 2, 3, 4	Yes	16	61, 62, 63, 64	No
2	5, 6, 7, 8	Yes	17	65, 66, 67, 68	No
3	9, 10, 11, 12	No	18	69, 70, 71, 72	No
4	13, 14, 15, 16	Yes	19	73, 74, 75, 76	No
5	17, 18, 19, 20	No	20	77, 78, 79, 80	No
6	21, 22, 23, 24	No	21	81, 82, 83, 84	No
7	25, 26, 27, 28	No	22	85, 86, 87, 88	No
8	29, 30, 31, 32	No	23	89, 90, 91, 92	No
9	33, 34, 35, 36	No	24	93, 94, 95, 96	No
10	37, 38, 39, 40	No	25	97, 98, 99, 100	Yes
11	41, 42, 43, 44	No	26	101, 102, 103, 104	Yes
12	45, 46, 47, 48	No	27	105, 106, 107, 108	No
13	49, 50, 51, 52	No	28	109, 110, 111, 112	No
14	53, 54, 55, 56	No	29	113, 114, 115, 116	No
15	57, 58, 59, 60	No	30	117, 118, 119, 120	No

Note: (1) Refer to the following example on scan interval computation where nine (9) channels 1, 2, 3, 4, 5, 7, 15, 100, and 101 are configured. (2) This table only shows 30 of the 248 maximum 4-channel blocks (992 channels) for the fully-expanded TempScan/1100 system.

Note: The *disposition* of the channel configuration *does not* affect MultiScan/1200 operation.

To Compute the TempScan/1100 Scan Interval

To compute the time interval for the TempScan/1100 to acquire one scan, use the following formulas:

- **For a 60 Hz line cycle:** Scan Interval is:

$$Is-t = [\text{Next highest integer } (Dv / 4)] \times R1$$
- **For a 50 Hz line cycle:** Scan Interval is:

$$Is-t = [\text{Next highest integer } (Dv / 4)] \times R2$$

Where:

Is-t = Scan Interval for the TempScan/1100, milliseconds.

Dv = Disposition, variable number of non-empty 4-channel blocks.

R1 = Sampling Rate, constant of 16.67 milliseconds (per 16-channel block) for a 60-Hz line cycle.

R2 = Sampling Rate, constant of 20.00 milliseconds (per 16-channel block) for a 50-Hz line cycle.

For example, if the nine (9) channels 1, 2, 3, 4, 5, 7, 15, 100, and 101 are configured, then there are five (5) non-empty 4-channel blocks (refer to the table on disposition). Using the scan interval formula for a TempScan/1100 system with a 60-Hz line cycle, gives:

$$Is-t = \text{Next highest integer } (5 / 4) \times 16.67 \text{ millisecond.}$$

$$Is-t = 2 \times 16.67 \text{ millisecond} = 33.33 \text{ millisecond.}$$

However, if nine (9) channels are configured less densely by every fourth channel from channel 4 through 36, then there are nine (9) non-empty 4-channel blocks. Using the same formula gives:

$$Is-t = \text{Next highest integer } (9 / 4) \times 16.67 \text{ millisecond.}$$

$$Is-t = 3 \times 16.67 \text{ millisecond} = 50.00 \text{ millisecond.}$$

Clearly, despite the identical number of configured channels, the disposition affects the TempScan/1100 scan interval. Meanwhile, the following table shows how the *fast mode* scan rate varies when the number of configured channels increases where these TempScan/1100 channels are all adjacent to each other.

Variations of the TempScan/1100 Fast Mode Scan Rate					
Number of 16-Channel Blocks	Number of Selected Channels	Scan Rate (Hz)			
		60-Hertz Line Cycle		50-Hertz Line Cycle	
		Hertz	milliseconds	Hertz	milliseconds
1	16	60	16.67	50	20
2	32	30	33.33	25	40
3	48	20	50.00	16.67	60
4	64	15	66.67	12.50	80
5	80	12	83.33	10.00	100
	
10	160	6.00	166.67	5.00	200
	
50	800	1.20	833.33	1.00	1000
	
60	960	0.909	1100.00	0.833	1200
61	976	0.984	1016.67	0.820	1220
62	992	0.968	1033.33	0.806	1240

Note: (1) The number of selected channels refer to configured channels which are all adjacent to each other. (2) These values were obtained from the above TempScan/1100 scan interval equations.

To Compute the MultiScan/1200 Scan Interval

To compute the time interval for the MultiScan/1200 to acquire one scan, use the following formulas:

- **For a 60-Hz Line Cycle:** Scan Interval equals:

$$IS-m = Cv \times (Wv + 12) \times R3$$

- **For a 50-Hz Line Cycle:** Scan Interval equals:

$$IS-m = Cv \times (Wv + 12) \times R4$$

Where:

IS-m = Scan Interval for the MultiScan/1200, milliseconds.

Cv = Channels, variable number of configured channels in the scan.

Wv = Sampling Weight, variable number of samples per channel.

R3 = Sampling Rate, constant of 0.52083 milliseconds (per sample) for a 60-Hz line cycle.

R4 = Sampling Rate, constant of 0.62500 milliseconds (per sample) for a 50-Hz line cycle.

For example, if 148 channels are configured, the disposition of these channels will not be a factor. Using the scan interval formula for a MultiScan/1200 system with a 60-Hz line cycle, if the system is configured to take 1 sample per channel, gives:

$$IS-m = 148 \times (1 + 12) \times 0.52083 \text{ millisecond.}$$

$$IS-m = 148 \times 13 \times 0.52083 \text{ millisecond} = 1002 \text{ millisecond} = 1.002 \text{ seconds.}$$

Meanwhile, the following table shows how the *fast mode* scan rate varies when the number of configured channels increases where these MultiScan/1200 channels are all adjacent to each other, and are using the default sampling weight of 32 samples per channel.

Variations of the MultiScan/1200 Fast Mode Scan Rate					
Number of 12-Channel Blocks	Number of Selected Channels	Scan Rate (Hz)			
		60-Hertz Line Cycle		50-Hertz Line Cycle	
		Hertz	seconds	Hertz	seconds
1	12	3.636	0.275	3.030	0.330
2	24	1.818	0.550	1.515	0.660
3	36	1.212	0.825	1.010	0.990
4	48	0.909	1.100	0.758	1.320
5	60	0.727	1.375	0.606	1.650
	
10	120	0.3636	2.750	0.3030	3.300
	
50	600	0.0727	13.750	0.0606	16.500
	
60	720	0.0606	16.500	0.0505	19.800
61	732	0.0596	16.775	0.0497	20.130
62	744	0.0587	17.050	0.0489	20.460

Note: (1) The number of selected channels refer to configured channels which are all adjacent to each other. (2) These values were obtained from the above MultiScan/1200 scan interval equations.

Acquisition Configuration

Configuring the Acquisition (Non-Burst Mode)

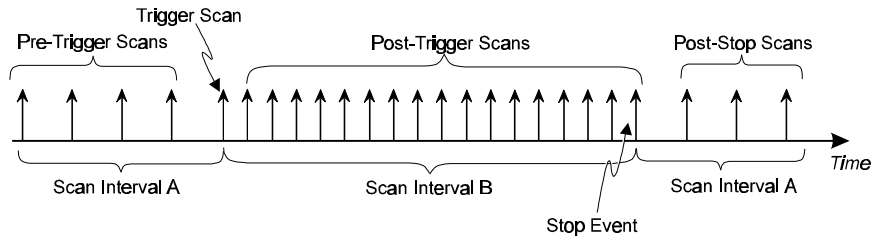

Acquisition Definition

After configuring each channel, it is necessary to configure the acquisition parameters to collect and buffer scans. An acquisition can consist of the following components:

- **Pre-Trigger:** The state in which scans are taken before the *Trigger* (trigger start event) is satisfied. This component is not required.
- **Post-Trigger:** The state in which scans are taken after the *Trigger* (trigger start event) and before the *Stop* (trigger stop event). Required, however if the *Post-Trigger* is set to 0, the *Trigger* scan is collected (1 scan) but no *Post-Stop* scans are collected
- **Post-Stop:** The state in which scans are taken after the *Stop* event. This component is not required.

These components constitute a single *Trigger Block* in the internal memory of the TempScan/1100 or MultiScan/1200 unit. Every *Trigger Block* has one and only one *Trigger* (trigger start event).

Pre-Trigger State

The *Pre-Trigger* state is the acquisition period before the *Trigger* (trigger start event), as set via the *Set Trigger Configuration* (τ) command. While the unit is in this state, the *TRIGGER* LED indicator will flash. As in any other acquisition state, the alarms and their associated outputs will be updated as follows: At the fastest rate possible under the current channel configuration, for the TempScan/1100; and at any programmed *Pre-Trigger* scan rate up to the fastest rate possible under the current channel configuration, for the MultiScan/1200.

During this state, the TempScan/1100 or MultiScan/1200 may be configured to collect *Pre-Trigger* data. This may be accomplished by specifying a non-zero value for the *Pre-Trigger pre* parameter of the *Set Counts* (χ) command. However, the *Pre-Trigger pre* value coupled with the current channel configuration cannot exceed the total amount of available memory.

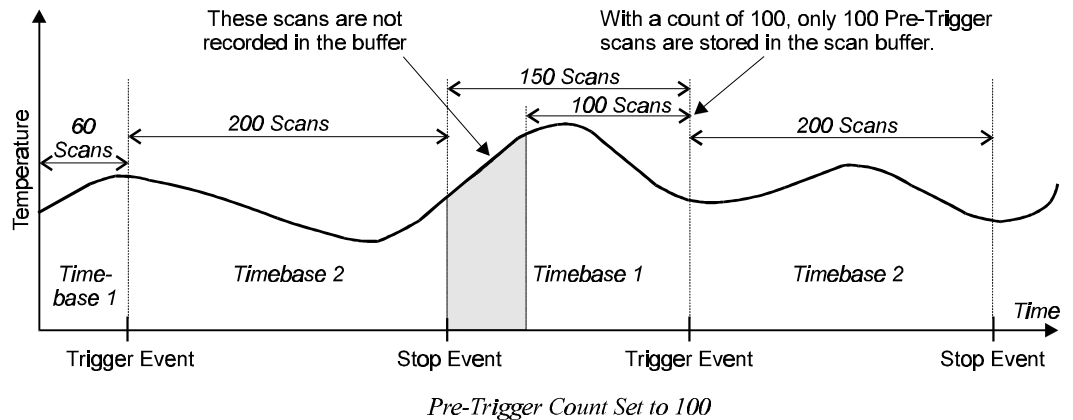

If the *Pre-Trigger pre* is set to a non-zero value, the TempScan/1100 or MultiScan/1200 will begin sampling *Pre-Trigger* data immediately after the *Set Trigger Configuration* (**T**) command is issued, at the rate specified by the current normal scan interval, as set via the *Set Scan Interval* (**I**) command.

When the *Trigger* start event occurs, the *Pre-Trigger* data portion of the *Trigger Block* will contain the most recent *Pre-Trigger* scans. The number of *Pre-Trigger* scans collected will depend upon when the *Trigger* occurs. If the *Trigger* occurs when the number of acquired *Pre-Trigger* scans is less than the specified *Pre-Trigger pre*, then that number of *Pre-Trigger* scans will be the number of *Pre-Trigger* scans collected to that point. Otherwise, if the *Trigger* occurs when the number of acquired *Pre-Trigger* scans is greater than the specified *Pre-Trigger pre*, then the number of *Pre-Trigger* scans will be the number specified by the *Pre-Trigger pre* parameter of the *Set Counts* (**Y**) command. If no acquisition data is desired while in the *Pre-Trigger* state, the *Pre-Trigger pre* parameter of the *Set Counts* (**Y**) command may be set to zero.

Pre-Trigger data may not be accessed while the TempScan/1100 or MultiScan/1200 unit is in the *Pre-Trigger* state. The *Pre-Trigger* data for a particular *Trigger Block* is not made available to be read until the specified *Trigger* occurs. There are two ways to determine if the unit is in the *Pre-Trigger* state:

- Check the TempScan/1100 or MultiScan/1200 front panel. If the *TRIGGER* LED indicator is flashing, then the unit is in the *Pre-Trigger* state.
- Query the Status Byte Register (**STB**) via the *User Status* (**U1**) command. If the acquisition has been configured and the Triggered Bit (Bit 1) is not set, then the unit is in the *Pre-Trigger* state. When the specified *Trigger* occurs, the TempScan/1100 or MultiScan/1200 exits the *Pre-Trigger* state and enters the *Post-Trigger* state.

Post-Trigger State

The *Post-Trigger* state is the acquisition period after the *Trigger* (trigger start event) and before the *Stop* (trigger stop event). While the unit is in this state, the *TRIGGER* LED indicator will be on. As in any other acquisition state, the alarms and their associated outputs will be updated as follows: At the fastest rate possible under the current channel configuration, for the TempScan/1100; and at any programmed *Post-Trigger* scan rate up to the fastest rate possible under the current channel configuration, for the MultiScan/1200.

During this state, the unit will collect *Post-Trigger* data at the rate specified by the acquisition scan interval, as set via the *Set Scan Interval* (**I**) command. *Post-Trigger* scans will be collected at this rate until the *Stop* event occurs. The number of scans collected during the *Post-Trigger* state is not restricted by the internal buffer size. The TempScan/1100 or MultiScan/1200 can collect scans in the *Post-Trigger* state indefinitely, if the controlling computer is capable of reading data out of the Acquisition Buffer fast enough to prevent a buffer overrun.

The *Post-Trigger* state may be detected by doing the following: Querying the Triggered Bit (Bit 1) of the Status Byte Register (**STB**) via the *User Status* (**U1**) command; and querying the Stop Event Bit (Bit 1) of the Event Status Register (**ESR**) via the *User Status* (**U0**) command. If and only if the Triggered Bit (Bit 1) of the **STB** is set, and the Stop Event Bit (Bit 1) of the **ESR** is not set, then the TempScan/1100 or MultiScan/1200 unit is in the *Post-Trigger* state. The unit will exit the *Post-Trigger* state when the *Stop* event occurs.

Post-Stop State

The *Post-Trigger* state is the acquisition period after the *Stop* (trigger stop event) until the completion of the acquisition. While the unit is in this state, the *TRIGGER* LED indicator will be on. As in any other acquisition state, the alarms and their associated outputs will be updated as follows: At the fastest rate possible under the current channel configuration, for the TempScan/1100; and at any programmed *Post-Stop* scan rate up to the fastest rate possible under the current channel configuration, for the MultiScan/1200.

If the *Post-Stop stop* parameter of the *Set Counts (Y)* command is set to a non-zero value, the TempScan/1100 or MultiScan/1200 will begin sampling *Post-Stop* data upon the occurrence of the *Stop* event, and will acquire the specified number of *Post-Stop* scans.

When the specified number of *Post-Stop* scans have been collected, the unit will terminate the current acquisition and return to a non-acquiring state. If, however, the *Post-Stop stop* parameter of the *Set Counts (Y)* command is zero, the unit will return immediately to a non-acquiring state upon the occurrence of the *Stop* event (unless the *Auto Re-arm* feature is used).

The *Post-Stop* state may be detected by querying the Stop Event Bit (Bit 1) and the Acquisition Complete Bit (Bit 0) of the Event Status Register (**ESR**). If and only if the Stopped Bit (Bit 1) of the **ESR** is set, and the Acquisition Complete Bit (Bit 0) of the **ESR** is not set, then the TempScan/1100 or MultiScan/1200 unit is in the *Post-Stop* state. The unit will exit the *Post-Stop* state when the specified number of *Post-Stop* scans have been acquired. When this occurs, the Acquisition Complete Bit (Bit 0) of the **ESR** will be set and the unit will return to a non-acquiring state (unless the *Auto Re-arm* feature is used).

Continuous, Gap-Free Acquisition with Two Timebases

The TempScan/1100 or MultiScan/1200 unit can be configured to have different timebases for its *Pre-Trigger* (normal scan interval) and *Post-Trigger* (acquisition scan interval) states. When the user-specified *Trigger* condition is satisfied, the unit switches from the *Pre-Trigger* to the *Post-Trigger* state, changing its timebase if configured to do so. This feature, along with *Auto Re-arm*, can be used to collect continuous, gap-free data at two different timebases.

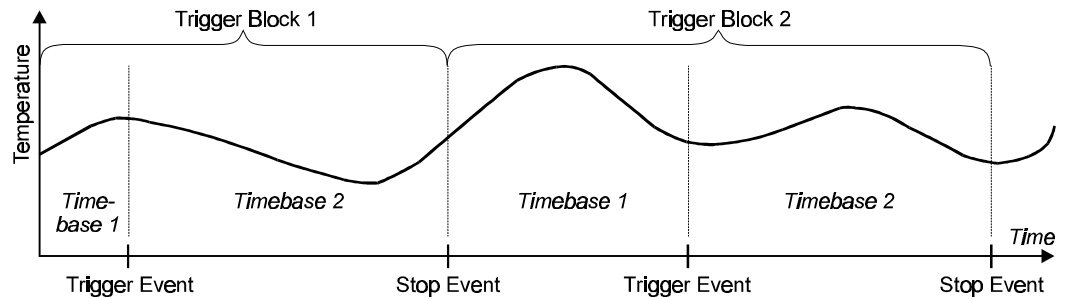

Buffer Organization with Gap-Free Acquisition

To ensure that the collected data is gap-free, the *Pre-Trigger pre* parameter of the *Set Counts (Y)* command must be set to **-1**. If a value of **0** or higher is used as the *Pre-Trigger pre* value, then that value is the maximum number of *Pre-Trigger* scans that can be placed in the Acquisition Buffer after the *Trigger* condition is satisfied.

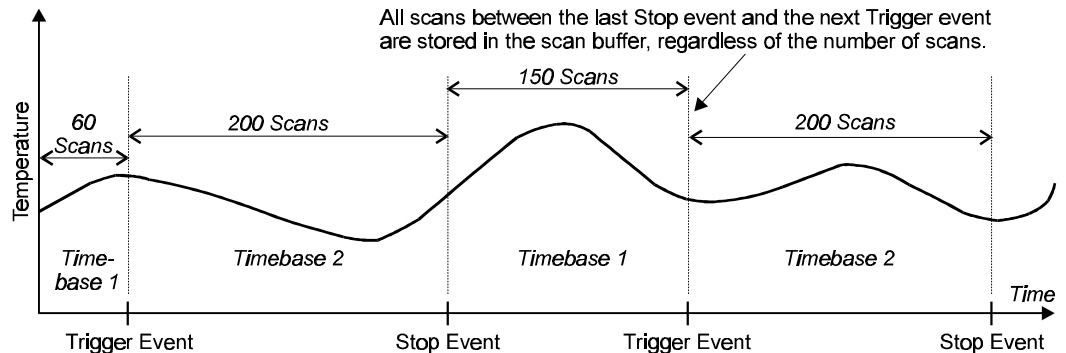

Pre-Trigger Count Set to -1

To enable the gap-free acquisition with two timebases, you must perform the following:

- Specify the two trigger events – the *Trigger* (trigger start event) and the *Stop* (trigger stop event) – via the *Set Trigger Configuration* (**T**) command.
- Set the two timebase intervals – the *normal* and the *acquisition* scan intervals – via the *Set Scan Interval* (**I**) command.
- Set the *Pre-Trigger* count to **-1**, via the **pre** parameter of the *Set Counts* (**Y**) command. If more than one transition cycle is desired, enable the *Auto Re-arm* flag of the *Set Trigger Configuration* (**T**) command to allow each transition cycle to be stored in its own *Trigger Block* within the buffer.

Using this method, continuous data may be collected as long as the application program can read data out of the Acquisition Buffer before the buffer overruns. If the buffer overruns, the data read may not be continuous.

Trigger Configuration

Trigger Start & Stop Events

The programmed system events are the driving force behind any acquisition. For an acquisition to take place, the *Set Trigger Configuration* (**T**) command is used as the central command to assign the following events to the TempScan/1100 or MultiScan/1200 unit: The *Trigger* (trigger start event) and the *Stop* (trigger stop event). The *Trigger* and *Stop* may also be assigned different trigger sources. In addition, the *Set Trigger Configuration* (**T**) command also determines whether or not, after the initial acquisition, the acquisition will be re-enabled automatically, and whether or not the *Trigger* (trigger start event) should be synchronized with the *Pre-Trigger* scan interval.

Upon the execution of this command, the unit will enter acquisition mode, and the *TRIGGER* LED indicator on the front panel will flash. If *Pre-Trigger* scans have been configured via the *Set Counts* (**Y**) command, then the sampling for *Pre-Trigger* data will begin at this time. Specifically, the *Set Trigger Configuration* (**T**) command is used to set the following parameters:

- ***Trigger (trigger start event)***: This parameter is the event that is to take place in order for the unit to begin acquiring scans. When the unit detects a *Trigger*, it will stop acquiring *Pre-Trigger* scans (if configured), and begin acquiring *Post-Trigger* scans at that point. The first of these *Post-Trigger* scans, the *Trigger* scan, will be Time/Date stamped for later reference, such as in a response to the following *User Status* (**U**) command query: **U6** – Query the Buffer Status String. Also, when the *Trigger* is detected, the Triggered Bit (Bit 1) of the Status Byte Register (**STB**) will be set and the *TRIGGER* LED indicator on the front panel will turn on.
- ***Stop (trigger stop event)***: This parameter is the event that is to take place in order for the unit to stop acquiring scans. When the unit detects a *Stop*, it will stop acquiring *Post-Trigger* scans at that point, unless *Post-Stop* scans are defined via the *Set Counts* (**Y**) command. The last of these *Post-Trigger* scans, the *Stop* scan, will be Time/Date stamped for later reference, such as in a response to the following *User Status* (**U**) command query: **U6** – Query the Buffer Status String. Also, when the *Stop* is recognized, the Triggered Bit (Bit 1) of the Status Byte Register (**STB**) will be cleared and the *TRIGGER* LED indicator on the front panel will turn off.

- Auto Re-arm:** This parameter is the feature which determines whether or not, after the initial acquisition, the acquisition will be re-enabled automatically. If the *Auto Re-arm* feature is in use, the TempScan/1100 or MultiScan/1200 unit will immediately begin looking for another *Trigger* event once a *Stop* event and *Post-Stop* count are detected to indicate that the current acquisition has terminated. When the next *Trigger* is detected, a new acquisition with the same channel configuration will be enabled automatically. Otherwise, if this feature is not in use, and the initial acquisition has terminated, a *Set Trigger Configuration* (\mathbf{T}) command must be issued after a *Stop* event, before the unit can begin looking for a *Trigger*.

However, using *Auto Re-arm* does not allow you to change the *Trigger* configuration between *Triggers*. Consequently, the initial configuration will be used until the *Auto Re-arm* is disabled. To disable the *Auto Re-arm* flag, a *Set Trigger Configuration* (\mathbf{T}) command must be issued with the **re-arm** parameter set to zero. Data will still be available after the \mathbf{T} command is issued.

- Trigger Synchronization:** This parameter is a flag which determines whether or not the *Trigger* (trigger start event) should be synchronized with the *Pre-Trigger* scan interval, provided that both the *Pre-Trigger* count and *normal* scan interval are configured via the *Set Counts* (\mathbf{Y}) and *Set Scan Interval* (\mathbf{I}) commands, respectively. If this flag is set, then the *Trigger* scans will begin on the next "tick" of the *Pre-Trigger* scan interval, regardless of the exact point in time when the actual *Trigger* occurred. So, if the actual *Trigger* occurs between "ticks" of the *Pre-Trigger* scan interval, then the acquisition will not begin until the next "tick" of the *Pre-Trigger* scan interval. Otherwise, the acquisition of *Post-Trigger* scans will begin independently at the exact point when the *Trigger* (trigger start event) is detected.

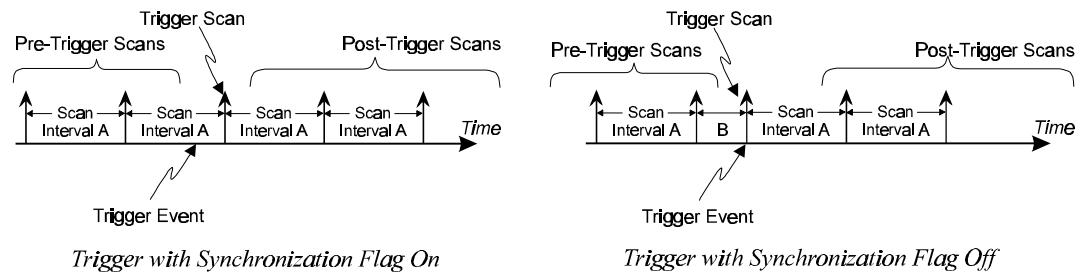

Trigger Start & Stop Event Sources

As already mentioned, the TempScan/1100 or MultiScan/1200 can be configured so that the *Trigger* and *Stop* are assigned different trigger sources. However, since the *Set Trigger Configuration* (\mathbf{T}) command governs the configuration of an acquisition, all other acquisition-dependent commands should be sent before the trigger sources are assigned via the *Set Trigger Configuration* (\mathbf{T}) command. The required acquisition-dependent commands will depend on the selected trigger sources. For instance, if the unit is configured for *Trigger On* ($\mathbf{@}$) command, it will not be necessary to send the unrelated *Set Trigger Level* (\mathbf{L}) command.

The *Trigger* and *Stop* can each be assigned any of the following sources:

- **@:** *Trigger* and/or *Stop* event. Trigger source type 1. When @ is selected as the trigger source, the *Trigger On* (@) command will generate a trigger.
- **GET:** *Trigger* and/or *Stop* event. Trigger source type 2. Not applicable for RS-232/RS-422 serial applications. When GET is selected as the trigger source, data collection will start when the IEEE 488 Group Execute Trigger (GET) command is sensed on the IEEE 488 bus and the TempScan/1100 or MultiScan/1200 unit is addressed to LISTEN.
- **TALK:** *Trigger* and/or *Stop* event. Trigger source type 3. Not applicable for RS-232/RS-422 serial applications. When TALK is selected as the trigger source, data collection will start when the TempScan/1100 or MultiScan/1200 unit is addressed to TALK.
- **Selected Temperature-Channel Level (Above or Below):** *Trigger* and/or *Stop* event. Trigger source types 4 and 5. When a selected temperature channel is specified as the trigger source, data collection will start when the level for the selected channel has been crossed (either above or below), as defined via the *Set Trigger Level* (L) command.
- **External TTL (Rising or Falling):** *Trigger* and/or *Stop* event. Trigger source types 6 and 7. When the External TTL Level is specified as a trigger source, a TTL level signal to the rear-panel BNC trigger connector will generate a trigger. The external trigger is edge sensitive, and triggering on the rising edge or falling edge can be specified.
- **Count (Post-Trigger):** *Trigger* and/or *Stop* event. Trigger source type 8. When Count is selected as the *Stop* event, scans will occur until the specified number of *Post-Trigger* scans have been acquired, as defined via the *Set Counts* (Y) command. At this point, the *Post-Trigger* acquisition will stop and if configured, the *Post-Stop* acquisition will begin.
- **Alarm (On or Off):** *Trigger* and/or *Stop* event. Trigger source types 9 and 10. When Alarm is selected as a trigger source, the acquisition will start or stop when any channel goes into or out of an alarm condition, as defined via the *Configure Channels* (C) command.
- **Absolute Time:** *Trigger* and/or *Stop* event. Trigger source type 11. When absolute time is specified as a trigger source, data collection will start when the real-time clock time equals the programmed time(s), as defined via the *Program Trigger Times* (P) command.

Note: For the MultiScan/1200 unit to recognize a *Trigger* (trigger start event) source which is set to TTL Level or Alarm, at least one *Pre-Trigger* scan must be programmed via the **pre** parameter of the *Set Counts* (Y) command, to initiate scanning.

For more information on *Trigger* and *Stop* configuration, see command *Set Trigger Configuration* (T) in the chapter *API Command Reference*.

Additional Configuration

Beyond the minimum required configurations, the TempScan/1100 or MultiScan/1200 provides further convenience and flexibility with the following optional configurations:

- *Configuration of the alarms.* See commands *Assign Digital Alarm Output* (A) and *Channel Configuration* (C).
- *Configuration of the stamps.* See commands *Set Scan Time Stamping* (*T), *Set Scan Alarm Stamping* (A#), and *Set Digital Input Stamping* (I#).
- *Configuration of the data format.* See command *Set Data Format* (F).
- *Configuration of the power-up.* See command *Set Power-Up Configuration* (*S).

Alarm Configuration

The TempScan/1100 or MultiScan/1200 unit can be programmed to produce an internal alarm event when the value of a channel is outside of user-defined limits. In turn, these alarm events can be used as sources for *Trigger* or *Stop* events, or as stimuli for TTL-level signals. To use the alarms, the relevant channels must be part of the channel scan. After an acquisition has been configured and armed, the alarms will be enabled and monitored. Since alarming is totally independent of buffered operations, the assignment of trigger events or scan intervals is not required.

Note: To enable alarm monitoring prior to, or have an alarm condition serve as, the *Trigger* or *Stop* event, you must first configure the acquisition with at least one *Pre-Trigger* scan.

Alarm Setpoints

Each channel has an associated high and low setpoint. Setpoints are defined as part of a channel configuration using the *Configure Channels (c)* command. These setpoints create the “envelope” that constitutes the normal channel operating range.

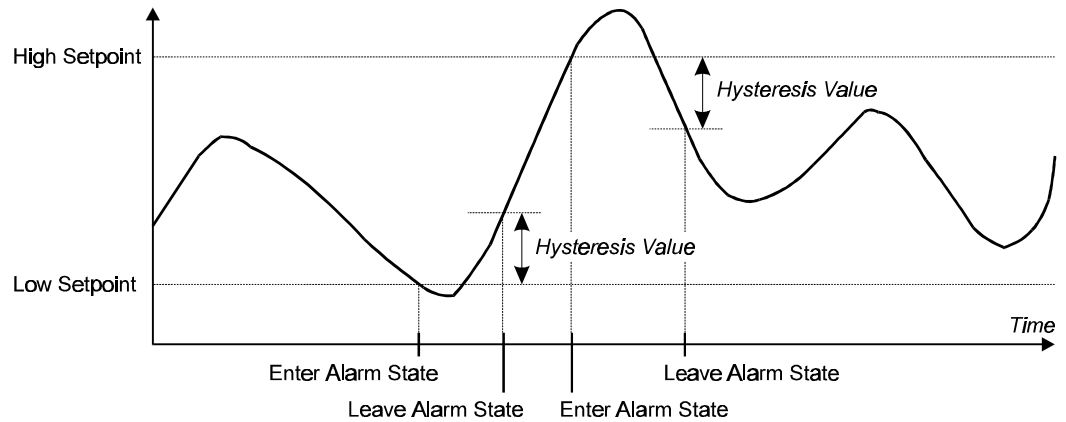

Alarm Setpoints, Hysteresis & States

If the channel value goes above the high setpoint or below the low setpoint, then the channel is in the alarm state. If any configured channel is in the alarm state, a system alarm event will be posted. In turn, if the *Trigger* event source is set to Alarm, this system alarm event would cause a *Trigger*.

Alarm Hysteresis

To avoid threshold transition problems, a hysteresis value can also be programmed. A hysteresis value provides a range for the alarm state. After the alarm setpoint is exceeded, the signal must drop below the high setpoint, or above the low setpoint, by the hysteresis value before the channel leaves the alarm state and the alarm is reset.

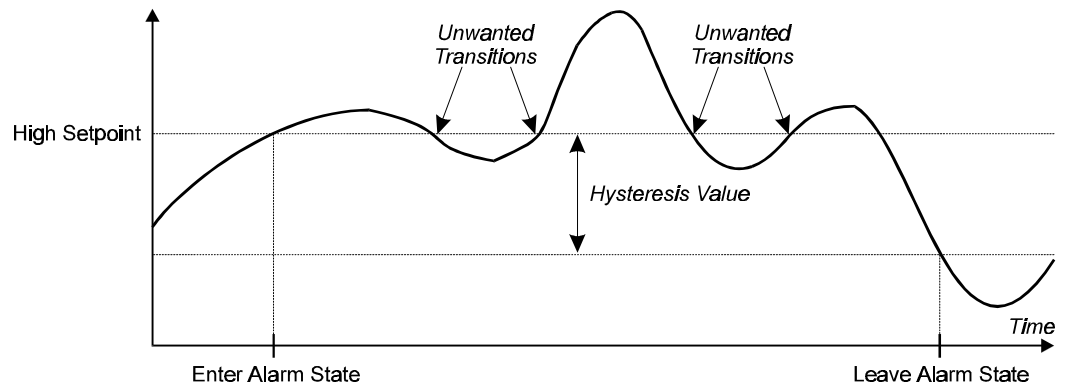

Alarm Hysteresis

For example, let us assume a channel has alarm setpoints of 100 and -100, and a hysteresis of 10. If 100 is exceeded, the channel will remain in the alarm state until the signal falls below 90. Or if -100 is exceeded, the channel will remain in the alarm state until the signal rises above -90.

Digital Alarm Outputs

If preferred, an alarm event for a specific channel can be used as a stimulus for a digital (TTL) output signal. In turn, this signal can be used to set off an audible alarm (user-supplied) or to communicate to another device that the alarm state has occurred.

Thirty-two (32) digital alarm outputs are available via the TempScan/1100 or MultiScan/1200 rear-panel DB50 connector. Although analog input channels on the Exp/10A or Exp/11A expansion unit can be used to stimulate alarms, neither of these expansion units provides digital alarm outputs. Consequently, regardless of the number of connected expansion units, the TempScan/1100 or MultiScan/1200 system can only provide 32 digital alarm outputs.

You can assign as many alarm states as you prefer to any digital output. To configure alarm conditions for driving the digital output lines, use the *Configure Channels (C)* and *Assign Digital Alarm Output (A)* commands. The former command determines the high setpoint, low setpoint and hysteresis of the alarm state, while the latter command assigns alarm states of a particular channel, or range of channels, to individual outputs of the 32 available digital alarm outputs.

Example 12b. TempScan/1100 Digital Alarm Output

```
(1) PRINT #1 "OUTPUT07: C1-32, 1, -1000.0, +1000.0, 10.0X"  
(2) PRINT #1 "OUTPUT07: A1, 1X"  
(3) PRINT #1 "OUTPUT07: A2, 2X"  
(4) PRINT #1 "OUTPUT07: A3, 2X"
```

The above program example demonstrates how to configure alarms and associate them with digital alarm outputs for 32 channels of the TempScan/1100:

- **Line 1:** Setup channels 1 to 32 with Type J thermocouples, low setpoint = -1000.0 °C, high setpoint = +1000.0 °C, and hysteresis = 10.0°C.
- **Line 2:** Assign alarm channel 1 to digital output 1.
- **Line 3:** Assign alarm channel 2 to digital output 2.
- **Line 4:** Assign alarm channel 3 to digital output 2. So Channel 2 or 3 can set digital output 2.

Example 12c. MultiScan/1200 Digital Alarm Output

```
(1) PRINT #1 "OUTPUT07: C1-24, 1, -500.0, +500.0, 50.0X"  
(2) PRINT #1 "OUTPUT07: A1, 1X"  
(3) PRINT #1 "OUTPUT07: A2, 2X"  
(4) PRINT #1 "OUTPUT07: A3, 2X"
```

The above program example demonstrates how to configure alarms and associate them with digital alarm outputs for 24 channels of the MultiScan/1200:

- **Line 1:** Setup channels 1 to 24 with Type J thermocouples, low setpoint = -500.0 °C, high setpoint = +500.0 °C, and hysteresis = 50.0°C.
- **Line 2:** Assign alarm channel 1 to digital output 1.
- **Line 3:** Assign alarm channel 2 to digital output 2.
- **Line 4:** Assign alarm channel 3 to digital output 2. With both Lines 3 and 4, either channel 2 or 3 can set digital output 2.

Comparing Buffered Data to Alarm Status Data

With the TempScan/1100 unit, unless scans are being collected at the maximum possible frequency, the alarm system may detect alarm states that will not appear in the collected data. Since the alarms are being updated at the maximum possible frequency, which may be considerably faster than the scan frequency as set by the programmed scan interval, an alarm state may be detected even though no such value can be found in the buffered scan data.

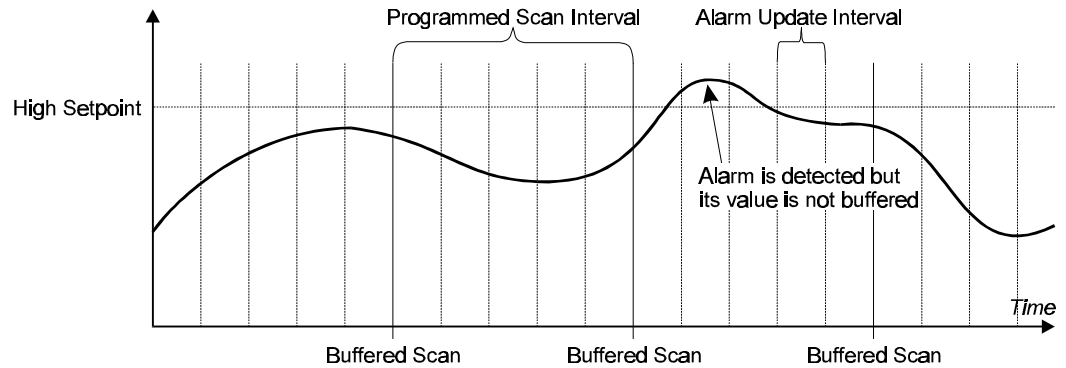

Alarm Data Versus Buffered Scan Data

If such a situation is not preferred, decreasing the programmed scan interval (thus increasing the scan frequency) will decrease the possibility of such an event. At the maximum possible scan frequency, this situation is guaranteed not to occur.

With the MultiScan/1200 unit, the alarms are being updated at the same frequency as set by the programmed scan interval. Hence, all detected alarm states will appear in the collected data.

Digital I/O Configuration

Located on the TempScan/1100 or MultiScan/1200 rear panel, the DB50 digital I/O connector provides eight (8) digital input lines and thirty-two (32) digital output lines. The digital output can be controlled either via the alarm settings or via the *Set Digital Outputs* (o) command. To query the digital output state, use the *Set Digital Outputs* (o) command.

The *Set Digital Outputs* (o) command allows you to force any of the 32 digital outputs, grouped into four 8-bit banks, to a specific setting. For each digital output, you can specify whether the bit should be cleared with a 0 (active low, logic **false**) or set with a 1 (active high, logic **true**). This command will override the current alarm output status as set via the *Assign Alarm Output* (A) command.

Each digital output line will drive five (5) standard TTL (transistor-transistor logic) loads. All digital input lines are one-eighth (0.125) TTL loads. All inputs are protected against damage from high static voltage. Normal precautions should be taken to limit the input voltages to the range of 0.0 to 5.3 volts. All digital I/O lines are referenced to digital ground.

For more information on digital I/O, see section *Digital I/O Configuration* in the chapter *TempScan/1100 & MultiScan/1200*, or see command *Set Digital Outputs* (o) in the chapter *API Command Reference*.

CAUTION



Do not exceed the levels described. Otherwise, the TempScan/1100 or MultiScan/1200 unit may be damaged in a way that is not covered by the warranty.

Stamp Configuration

Scan Time Stamping

The contents of each scan contains one reading for each of the configured channels. Optionally, time stamping of each scan can be enabled with the *Set Scan Time Stamping* (*T) command. Either absolute or relative time stamping may be specified. For more information, see command *Set Scan Time Stamping* (*T) in the chapter *API Command Reference*.

Note: (1) Relative time stamping is not valid when you attempt to use it in conjunction with continuous, gap-free acquisitions with two timebases. (2) With MultiScan/1200 only, time stamping is not valid in single-channel high-speed burst mode.

Example 12d. Absolute Time Stamping Enabled

```
(1) PRINT#1, "OUTPUT07;*T1X"  
(2) PRINT#1, "OUTPUT07;R3X"  
(3) PRINT#1, "ENTER07"  
(4) INPUT A$  
      07:35:22.400,08/29/94R+0234.20-0019.40+0001.40+0023.60....
```

The above program example demonstrates how to enable absolute time stamping:

- **Line 1:** Enable absolute time stamping.
- **Line 2:** Request all scan data in buffer.
- **Line 3:** Retrieve the data.
- **Line 4:** The screen will show the scan data in the buffer, stamped with the absolute time.

Note: The **R** character (following the absolute time in the above code) is a reading separator which has been assigned via the **sep** parameter of the *Set Query Terminator* (Q) command.

Example 12e. Relative Time Stamping Enabled

```
(1) PRINT#1, "OUTPUT07;*T2X"  
(2) PRINT#1, "OUTPUT07;R3X"  
(3) PRINT#1, "ENTER07"  
(4) INPUT A$  
      +00:01:05.5,0000001 R +0234.20 -0019.40 +0001.40 +0023.60....
```

The above program example demonstrates how to enable relative time stamping:

- **Line 1:** Enable relative time stamping.
- **Line 2:** Request all scan data in buffer.
- **Line 3:** Retrieve the data.
- **Line 4:** The screen will show the scan data in the buffer, stamped with the relative time.

Note: The **R** character (following the relative time in the above code) is a reading separator which has been assigned via the **sep** parameter of the *Set Query Terminator* (Q) command.

Example 12f. Scan Time Stamping Disabled (Default)

```
(1) PRINT#1, "OUTPUT07;*T0X"
(2) PRINT#1, "OUTPUT07;R3X"
(3) PRINT#1, "ENTER07"
(4) INPUT A$
      +0234.20 -0019.40 +0001.40 +0023.60
```

The above program example demonstrates how to disable time stamping:

- **Line 1:** Disable time stamping.
- **Line 2:** Request all scan data in buffer.
- **Line 3:** Retrieve the data.
- **Line 4:** The screen will show the scan data in the buffer, without a time stamp.

Scan Alarm Stamping

Note: In an 8-bit byte, Bits 00 through 07 correspond to digital input/output (DIO) lines 1 through 8. Also, Bit *n* corresponds to the decimal value 2^{*n*} (where *n* is an integer from 00 to 07).

As a further option in the monitoring and analysis of alarm conditions, the states of the 32 digital alarm outputs can be stamped to each scan in real time.

```
+0234.20-0019.40+0001.40+0023.60 005 128 032 066
                                   Alarm Output Codes
```

(1) Convert alarm output codes from a decimal number to 8-place binary.

005	128	032	066
00000101	10000000	00100000	01000010

(2) Align binary digits with alarm outputs lines 1 through 32 as follows:

00000101	10000000	00100000	01000010
8.....3...1	16.....9	24..22.....17	32..31..26..25

(3) Determine the status of the alarm output lines where:

- 1 = Alarm output is "ON" and
 - 0 = Alarm output is "OFF"
- In this example, alarm outputs 1, 3, 16, 22, 26, and 31 are "ON."

How to Decode Alarm Outputs

Alarm stamping of each scan can be enabled with the *Set Scan Alarm Stamping (A#)* command. For more information, see command *Set Scan Alarm Stamping (A#)* in the chapter *API Command Reference*.

Note: With MultiScan/1200 only, alarm stamping is not valid in single-channel high-speed burst mode, since alarms are not monitored.

Note: If digital input stamping has also been enabled via the *Set Digital Input Stamping (I#)* command, then the digital input states will be stamped after the alarm output states have been stamped.

Example 12g. Scan Alarm Stamping Enabled

```
(1) PRINT#1, "OUTPUT07;A#1X"  
(2) (Command lines to configure and start an acquisition.)  
(3) PRINT#1, "OUTPUT07;R1X"  
(4) PRINT#1, "ENTER07"  
(5) INPUT A$  
      +0234.20 -0019.40 +0001.40 +0023.60 005 128 032 066
```

The above program example demonstrates how to enable alarm stamping:

- **Line 1:** Enable alarm stamping.
- **Line 2:** Provide the appropriate command lines to configure and start an acquisition.
- **Line 3:** Request the next scan in the buffer.
- **Line 4:** Retrieve the scan.
- **Line 5:** The screen will show the scan data in the buffer, stamped with the alarm output states.

Example 12h. Scan Alarm Stamping Disabled (Default)

```
(1) PRINT#1, "OUTPUT07;A#0X"  
(2) (Command lines to configure and start an acquisition.)  
(3) PRINT#1, "OUTPUT07;R1X"  
(4) PRINT#1, "ENTER07"  
(5) INPUT A$  
      +0234.20 -0019.40 +0001.40 +0023.60
```

The above program example demonstrates how to disable alarm stamping:

- **Line 1:** Disable alarm stamping.
- **Line 2:** Provide the appropriate command lines to configure and start an acquisition.
- **Line 3:** Request the next scan in the buffer.
- **Line 4:** Retrieve the scan.
- **Line 5:** The screen will show the scan data in the buffer, without an alarm stamp.

Digital Input Stamping

Note: In an 8-bit byte, Bits 00 through 07 correspond to digital input/output (DIO) lines 1 through 8. Also, Bit n corresponds to the decimal value 2^n (where n is an integer from 00 to 07).

The *Set Digital Input Stamping* (I#) command allows you to see whether a digital input was “active” or “inactive” at the time of the scan. This is accomplished by appending a digital input on/off code to the scan.

```
+0234.20-0019.40+0001.40+0023.60 036 000  
                                     Digital Input Codes
```

(1) Convert digital input codes from a decimal number to 8-place binary.

036	000
00100100	00000000

(2) Align binary digits with digital input lines 1 through 8 as follows:

00100100	00000000
8...6.....3...1	Not Used

(3) Determine the status of the digital input lines where:

1 = Digital input is "ON" and
0 = Digital input is "OFF"

Thus, in this example, digital inputs 3 and 6 are "ON."

How to Decode Digital Inputs

With digital input stamping, the “on” (1) or “off” (0) states of the 8 digital inputs can be stamped to each scan in real time. Digital input stamping of each scan can be enabled with the *Set Digital Input Stamping (I#)* command. For more information, see command *Set Digital Input Stamping (I#)* in the chapter *API Command Reference*.

To make use of this command, EEPROM memory upgrades are required, as follows:

- **For the TempScan/1100:** Requires the TEMP/1100/UPG upgrade package, with EEPROM #446-0300-1, Version 1.2 or greater.
- **For the TempScan/1000A:** Requires the TEMP/1000A/UPG upgrade package, with EEPROM #403-0300-1, Version 2.1 or greater.
- **For the MultiScan/1200:** Requires the MULTI/1200/UPG upgrade package, with EEPROM #264-0300-1, Version 2.1 or greater.

Note: The document *Firmware Upgrade* (#403-0922) details how to install the new EEPROM upgrades.

Note: With MultiScan/1200 only, alarm stamping is not valid in single-channel high-speed burst mode.

Note: If scan alarm stamping has also been enabled via the *Set Scan Alarm Stamping (A#)* command, then the digital input states will be stamped after the alarm output states have been stamped.

Example 12i. Digital Input Stamping Enabled

```
(1) PRINT#1, "OUTPUT07;I#1X"
(2) (Command lines to configure and start an acquisition.)
(3) PRINT#1, "OUTPUT07;R1X"
(4) PRINT#1, "ENTER07"
(5) INPUT A$
      +0234.20 -0019.40 +0001.40 +0023.60 036 000
```

The above program example demonstrates how to enable digital input stamping:

- **Line 1:** Enable digital input stamping.
- **Line 2:** Provide the appropriate command lines to configure and start an acquisition.
- **Line 3:** Request the next scan in the buffer.
- **Line 4:** Retrieve the scan.
- **Line 5:** The screen will show the scan data in the buffer, stamped with the digital input states.

Example 12j. Digital Input Stamping Disabled (Default)

```
(1) PRINT#1, "OUTPUT07;I#0X"
(2) (Command lines to configure and start an acquisition.)
(3) PRINT#1, "OUTPUT07;R1X"
(4) PRINT#1, "ENTER07"
(5) INPUT A$
      +0234.20 -0019.40 +0001.40 +0023.60
```

The above program example demonstrates how to disable digital input stamping:

- **Line 1:** Disable digital input stamping.
- **Line 2:** Provide the appropriate command lines to configure and start an acquisition.
- **Line 3:** Request the next scan in the buffer.
- **Line 4:** Retrieve the scan.
- **Line 5:** The screen will show the scan data in the buffer, without a digital input stamp.

Data Format Configuration

Readings from the TempScan/1100 or MultiScan/1200 are outputted in the format that you have configured. The *Set Data Format* (**F**) command determines whether Engineering Units converted from ASCII, a Binary format, or an unconverted ASCII raw-data count is used; and if Engineering Units is selected, determines what kind of Engineering Units is used.

All commands and input data issued by the PC/IEEE 488 controller to the TempScan/1100 or MultiScan/1200 unit are in ASCII code (in converted Engineering Units or unconverted ASCII Counts). Only output data supplied by the TempScan/1100 or MultiScan/1200 unit, such as Time/Date stamps for High/Low/Last registers, may be returned in Binary format. Both the IEEE 488 and RS-232/RS-422 interfaces support data retrieval in ASCII code (in converted Engineering Units or unconverted ASCII Counts) and, for high-speed applications, in Binary format. The terminators End of Reading and End of Scan are not used with Binary data transfers. For the IEEE 488 interface, EOI is asserted on the last byte.

The available options for the basic data format, via the **format** parameter of the *Set Data Format* (**F**) command, include: Engineering Units (default), Binary with High Byte first, Binary with Low Byte first, and ASCII Count. In turn, the available options for the Engineering Units, via the **enrg** parameter, include: Degrees Celsius ($^{\circ}C$, default), Degrees Fahrenheit ($^{\circ}F$), Degrees Rankine ($^{\circ}R$), Degrees Kelvin ($^{\circ}K$), and Volts (V).

Data Input Formats

Before reading the acquisition data, issuing the *Set Data Format* (**F**) command determines the format of input data – in the form of command parameters – coming from the PC/IEEE 488 controller. However, the only command parameters for which the **F** command can determine the data input format, are the high setpoint, low setpoint, and the hysteresis parameters of the *Configure Channels* (**C**) command, and the level and hysteresis parameters of the *Set Trigger Level* (**L**) command. These are the only command parameters over which the *Set Data Format* (**F**) command has control.

Note: (1) The above channel and *Trigger* level parameters cannot be interpreted as a Binary format. (2) If an Engineering Units or Binary format is selected as the data *input* format, then the channel and *Trigger* level values will be interpreted as Engineering Units. (3) If the ASCII Count format is selected as the data *input* format, then the channel and *Trigger* level values will be interpreted as Count, and the Engineering Units **enrg** parameter will be ignored.

Example 12k. Data Input Format Cases

```
PRINT#1,"OUTPUT07; F0,0X"
```

- **Case 1:** This command line interprets the relevant high setpoint, low setpoint, level, and/or hysteresis parameters as Engineering Units, Degrees C for the next **C** or **L** command issued.

```
PRINT#1,"OUTPUT07; F1,1X"
```

- **Case 2:** This command line interprets the relevant high setpoint, low setpoint, level, and/or hysteresis parameters as Engineering Units, Degrees F (even though the Binary format is specified) for the next **C** or **L** command issued.

```
PRINT#1,"OUTPUT07; F3,3X"
```

- **Case 3:** This command line interprets the relevant high setpoint, low setpoint, level, and/or hysteresis parameters as ASCII Counts for the next **C** or **L** command issued. In this case, the Engineering Units **enrg** parameter is ignored.

Data Output Formats

During or after the acquisition, issuing the *Set Data Format* (**F**) command determines the format of output data coming from the TempScan/1100 or MultiScan/1200 unit. However, data output formats differ slightly from data input formats in that Binary formats may be used, and used only for the output of channel data. *Channel data*, defined as data originating from the High/Low/Last (HLL) Registers or the Acquisition Buffer, may also be output in the Engineering Units or ASCII Count format as well as the Binary format.

The commands which can initiate channel data output (in Engineering Units, Binary, or ASCII Counts format) are the *Read Buffered Data* (**R**), *Read Last Readings* (**R#**), and following *User Status* (**U**) command queries: Query current HLL Registers (**U4**), Query and clear current HLL Registers (**U5**) and Query last scan read (**U13**). Meanwhile, the three commands queries which can initiate output in ASCII Count format are the following: Query current channel configuration (**C?**), Query the current trigger level settings (**L?**), and Query configured channels (**U8**).

Note: (1) Channel data is the only output data which may use the Binary format. If the Binary format is selected, then the Engineering Units **engr** parameter will be ignored. (2) For all other types of output data, if an Engineering Units or Binary format is selected as the data *output* format, then these output data values will be interpreted as Engineering Units. (3) If the ASCII Count format is selected as the data *output* format, then the output data values will be interpreted as Count, and the Engineering Units **engr** parameter will be ignored.

Example 12I. Data Output Format Cases

```
PRINT#1,"OUTPUT07; F0,0X"
```

- **Case 1:** This command line interprets the output data as Engineering Units, Degrees C for the next **R**, **R#**, **U4**, **U5**, or **U13** command issued, and also for the next **C?**, **L?**, or **U8** command issued.

```
PRINT#1,"OUTPUT07; F1,1X"
```

- **Case 2:** This command line interprets the output data as Binary for the next **R**, **R#**, **U4**, **U5**, or **U13** command issued (only channel data can be in Binary format), but also interprets the output data as Engineering Units, Degrees F for the next **C?**, **L?**, or **U8** command issued.

```
PRINT#1,"OUTPUT07; F3,3X"
```

- **Case 3:** This command line interprets the output data as ASCII Counts for the **R**, **R#**, **U4**, **U5**, or **U13** command issued, and also for the next **C?**, **L?**, or **U8** command issued. In this case, the Engineering Units **engr** parameter is ignored.

Engineering Units Format

If the Engineering Units data format is selected, the TempScan/1100 or MultiScan/1200 will interpret and supply data in a format appropriate for the configured thermocouple or volts channel type. In the Engineering Units format, both input and output data formats are valid for the following data:

- **Temperature:** For channels configured as thermocouples, the TempScan/1100 or MultiScan/1200 converts and returns all ASCII raw-data readings in the format which corresponds with the Engineering Unit selected. To obtain the default temperature unit of degrees Celsius ($^{\circ}\text{C}$), the ASCII raw-data values (ASCII integers ± 32767) are converted by dividing them by 10, such that $-3276.7 \leq ^{\circ}\text{C} \leq +3276.7$. Therefore, the default resolution of returned output data is 0.1°C .

The temperature format is as follows where **x** represents an ASCII digit: $\pm\text{xxxx}.xx$. Meanwhile, the ASCII raw-data conversion varies with the temperature units, as follows:

- Degrees Celsius ($^{\circ}\text{C}$, default): $^{\circ}\text{C} = (\text{Raw ASCII Count}) / 10$.
 - Degrees Fahrenheit ($^{\circ}\text{F}$): $^{\circ}\text{F} = (9/5)^{\circ}\text{C} + 32$.
 - Degrees Rankine ($^{\circ}\text{R}$): $^{\circ}\text{R} = (9/5)^{\circ}\text{C} + 491.69$.
 - Degrees Kelvin ($^{\circ}\text{K}$): $^{\circ}\text{K} = ^{\circ}\text{C} + 273.16$.
- **Volts:** For channels configured as volts, the TempScan/1100 or MultiScan/1200 converts and returns all ASCII raw-data readings. The ASCII raw-data range is scaled-down such that the fractions 4.4/4.5 (for volts) and 4.3939/4.5 (for high-voltage) of the ASCII raw-data range ± 32767 , gives the adjusted ranges ± 32038.84444 (for volts), and ± 31994.42695 (for high-voltage), respectively.

The volts format is as follows where **x** represents an ASCII digit: $\pm\text{xxx}.xxxxxxx$. Meanwhile, the ASCII raw-data conversion, and the resolution is dependent upon the volts range, as follows:

- $\pm 0.1\text{ V}$: $\text{V} = (\text{Raw Count}) / (32038.84444 \times 10)$ with a resolution of $3.12\ \mu\text{V/bit}$.
 - $\pm 1.0\text{ V}$: $\text{V} = (\text{Raw Count}) / (32038.84444 \times 1.0)$ with a resolution of $31.2\ \mu\text{V/bit}$.
 - $\pm 5.0\text{ V}$: $\text{V} = (\text{Raw Count}) / (32038.84444 \times 0.2)$ with a resolution of $156\ \mu\text{V/bit}$.
 - $\pm 10.0\text{ V}$: $\text{V} = (\text{Raw Count}) / (32038.84444 \times 0.1)$ with a resolution of $312\ \mu\text{V/bit}$.
 - $\pm 2.5\text{ V}$: $\text{V} = (\text{Raw Count}) / (31994.42695 \times 0.4)$ with a resolution of $78.14\ \mu\text{V/bit}$.
 - $\pm 25.0\text{ V}$: $\text{V} = (\text{Raw Count}) / (31994.42695 \times 0.04)$ with a resolution of $781.4\ \mu\text{V/bit}$.
 - $\pm 250\text{ V}$: $\text{V} = (\text{Raw Count}) / (31994.42695 \times 0.004)$ with a resolution of $7.81\ \text{mV/bit}$.
- **Time/Date and Time/Date Stamping:** The TempScan/1100 or MultiScan/1200 interprets and supplies Time/Date data in slightly different formats, depending on whether the data is input or output, and if it is output from the HLL Registers via Acquisition Buffer output queries, whether the data represents an *absolute* or a *relative* time stamping.

The Time/Date data will have the following ASCII-based formats:

- Time/Date input data: **hh:mm:ss.t,MM/DD/YY**.
- Time/Date output data (*absolute time stamping*): **hh:mm:ss.mil,MM/DD/YY**.
- Time/Date output data (*relative time stamping*): **\pm hh:mm:ss.mil,DDDDDD**. (Negative values indicate *Pre-Trigger* scans, whereas positive values indicate *Post-Trigger* scans.)

Where the ASCII-based format variables are as follows:

- **hh:** Hours such that $00 \leq \text{hh} \leq 23$.
- **mm:** Minutes such that $00 \leq \text{mm} \leq 59$.
- **ss:** Seconds such that $00 \leq \text{ss} \leq 59$.
- **t:** Tenths of a second such that $0 \leq \text{t} \leq 9$.
- **mil:** Milliseconds such that $000 \leq \text{mil} \leq 999$.
- **MM:** Months such that $01 \leq \text{MM} \leq 12$.
- **DD:** Days such that $01 \leq \text{DD} \leq 31$.
- **YY:** Years such that $00 \leq \text{YY} \leq 99$.
- **DDDDDD:** Days such that $0 \leq \text{D} \leq 9$.

- **Timebase (Scan Interval):** The timebase (or scan interval) data will have the same ASCII-based format as the Time/Date input data format, but without the date as follows: **hh:mm:ss.t**

Binary Format

As previously discussed, the Binary data format may be used only for the output of channel data, where *channel data* is defined as data originating from the High/Low/Last (HLL) Registers or the Acquisition Buffer of the TempScan/1100 or MultiScan/1200 unit. For all other types of data, input or output, if the Binary format is selected via the **format** parameter of the *Set Data Format (F)* command, then these data values will be interpreted as Engineering Units.

Note: Channel data is the only output data which may use the Binary format. If the Binary format is specified for channel data, then the Engineering Units **engr** parameter will be ignored.

Note: When Binary formats are specified, the **hll**, **scan**, and **block** parameters of the *Set Query Terminator (Q)* command do not apply. These parameters refer to the High/Low/Last (HLL), Scan, and *Trigger Block* terminators, respectively.

Note: Binary numbers can represent either positive or negative decimal values. Programs using Binary data will know how to decipher the sign of the decimal value by the Binary number alone. Refer to the Binary-to-ASCII number conversion table.

Note: Data in Binary format is not printable. The Binary data must be converted to ASCII format for printability. Consequently, no query terminators are used in Binary format.

The Binary format is valid for the following channel data output only. All other data under this Binary option will be interpreted as Engineering Units.

- **Temperature:** For channels configured as thermocouples, the Binary data consists of two 8-bit bytes which can be output in either high/low-byte or low/high-byte format. Each byte is in 2h (two-digit hexadecimal) format.
- **Volts:** Similarly for channels configured for voltage, the Binary data consists of two 8-bit bytes which can be output in either high/low-byte or low/high-byte format. Each byte is in 2h (two-digit hexadecimal) format.
- **Time/Date Stamping:** If Binary format is selected, the channel data output will also include Time/Date Stamping. The HLL Registers of the TempScan/1100 or MultiScan/1200 supplies Time/Date output data in slightly different formats, depending on whether the data represents an *absolute* or a *relative* time stamping.

With either the high/low-byte or low/high-byte selection, the Time/Date Stamping data consists of ten 8-bit bytes, as follows:

- Absolute time stamping: **hmstuvwMDY**
- Relative time stamping: **hmstuvwDEF**.

Where each of the ten letters represents one 8-bit byte in 2h (two-digit hexadecimal) format, as follows (refer to the Binary-to-ASCII number conversion tables):

- **h:** Hours such that $\$00 \leq h \leq \FF (where decimal: $-23 \leq h \leq 23$).
- **m:** Minutes such that $\$00 \leq m \leq \FF (where decimal: $-59 \leq m \leq 59$).
- **s:** Seconds such that $\$00 \leq s \leq \FF (where decimal: $-59 \leq s \leq 59$).
- **tuvw:** (Together as 4 bytes, low-to-high byte) Microseconds such that $\$00000000 \leq tuvw \leq \$FFFFFFFF$ (where decimal: $-999999 \leq tuvw \leq 999999$).
- **M:** Months such that $\$01 \leq M \leq \$0C$ (decimal: $01 \leq M \leq 12$).
- **D:** Days such that $\$01 \leq D \leq \$1F$ (decimal: $01 \leq D \leq 31$).
- **Y:** Years such that $\$00 \leq Y \leq \63 (decimal: $00 \leq Y \leq 99$).
- **DEF:** (Together as 3 bytes, low-to-high byte) Days such that $\$000000 \leq DEF \leq \$FFFFFF$ (where decimal: $-999999 \leq DEF \leq 999999$).

Binary-to-ASCII Number Conversion Tables

One 4-Bit Binary Digit (Positive Values)							
Binary (Hexadecimal)	\$0-\$9	\$A	\$B	\$C	\$D	\$E	\$F
ASCII Equivalent (Decimal)	0-9	10	11	12	13	14	15

One 8-Bit Byte Binary Format		Two 8-Bit Bytes Binary Format	
Binary (Hexadecimal)	ASCII Equivalent (Decimal)	Binary (Hexadecimal)	ASCII Equivalent (Decimal)
\$FF	-1	\$FFFF	-1
...	(negative values)	...	(negative values)
\$81	-127	\$8001	-32767
(\$80)	(128)	(\$8000)	(32768)
\$7F	+127	\$7FFF	+32767
...	(positive values)	...	(positive values)
\$00	0	\$0000	0

Three 8-Bit Bytes Binary Format		Four 8-Bit Bytes Binary Format	
Binary (Hexadecimal)	ASCII Equivalent (Decimal)	Binary (Hexadecimal)	ASCII Equivalent (Decimal)
\$FFFFFF	-1	\$FFFFFFFF	-1
...	(negative values)	...	(negative values)
\$800001	-8,388,607	\$80000001	-2,147,483,647
(\$800000)	(8,388,608)	(\$80000000)	(2,147,483,648)
\$7FFFFFF	+8,388,607	\$7FFFFFFF	+2,147,483,647
...	(positive values)	...	(positive values)
\$000000	0	\$00000000	0

Counts Format

The ASCII Count data format is a format that is characterized by an ASCII integer number (decimal from -32767 to +32767; hexadecimal from \$8001 to +\$FFFF, then from \$0000 to +\$7FFF) which represents a compensated or raw-data value as it would be interpreted from an analog-to-digital (A/D) converter. This Count format and value depends on the channel type which has been specified for that channel. For example, if Channel 16 is assigned channel type 1 (thermocouple Type J with cold-junction compensation and linearization), then the Count format and value for this channel would also be cold-junction compensated and linearized. Conversely, if Channel 16 is assigned channel type 31 (thermocouple Type J without temperature sensor adjustment – raw A/D data), then the Count format and value for this channel would also be raw.

Note: If the ASCII Count format is specified as the data format, then the appropriate temperature and volts data values will be interpreted as Count, and the Engineering Units **engr** parameter will be ignored.

In the ASCII Count data format, both input and output data formats are valid for the following data only. All other data under this Count option will be interpreted as Engineering Units.

- **Temperature:** For channels configured as thermocouples, the TempScan/1100 or MultiScan/1200 does not convert, but instead, keeps and returns all ASCII raw-data readings in its unconverted format, as an ASCII integer from -32767 to +32767. The temperature format is as follows where **x** represents an ASCII digit: **±xxxxx**.
- **Volts:** For channels configured as thermocouples, the TempScan/1100 or MultiScan/1200 does not convert, but instead, keeps and returns all ASCII raw-data readings in its unconverted format, as an ASCII integer from -32767 to +32767. The volts format is as follows where **x** represents an ASCII digit: **±xxxxx**.

Data Output Terminators

In addition to formatting the data readings themselves, you can format the output arrangement between data readings with various data output (or query) terminators. The *Set Query Terminator* (Q) command is used to set the following data output terminators:

- **Response Terminator:** This terminator is used for general purpose queries which do not request High/Low/Last (HLL) or Acquisition Buffer data. This terminator is used in all query responses unless the query refers to data in the High/Low/Last registers or the Acquisition Buffer. Such queries have their own specific terminators as described below.
- **Channel Terminator:** This terminator is used for queries which request data residing in the High/Low/Last (HLL) Registers. When this terminator is specified, the terminator will be inserted between each channel response.
- **Scan Terminator:** This terminator follows each scan that is output when a query request is made for Acquisition Buffer data. When this terminator is specified, this terminator will be used to terminate each scan as it is output to the unit. This will be true except for the last scan in the *Trigger Block*. In this case, the *Trigger Block* terminator will be used to terminate the scan and the *Trigger Block*.
- **Trigger Block Terminator:** This terminator follows each *Trigger Block* that is output when a query request is made for Acquisition Buffer data. When this terminator is specified, this terminator will be used to terminate each *Trigger Block* as it is output to the unit.
- **Separator Terminator:** This terminator is a reading separator character which should be placed between each returned reading in the Acquisition Buffer scan data. The valid options for this terminator include the following values: **0** - Place no separators in returned buffered scan data when it is read, and **1** - Place a separator into the returned buffer data when it is read. The separator is a user-defined terminator corresponding to the ASCII decimal value **va1**, as defined by the *Set User Terminator* (V) command.

Data Output Terminator Usage						
Command	Command Options	Argument				
		resp	hll	scan	block	sep
Read Buffered Data	R1			X		O
	R2,R3			O	X	O
Read Last Readings	R#chan			X		
	R#first-last		O	X		
User Status	U4,U5,U13		O	X		
All Other Commands	All Other Options	X				

This table summarizes the usage of query terminators with all possible commands in printable ASCII format, where the table symbols indicate the following meanings:

- The symbol **X** indicates that the terminator is asserted at the end of the response.
- The symbol **O** indicates that the terminator is asserted within the response to separate channel and scan readings.
- A blank cell indicates that the terminator does not affect the command.

Note: Data in Binary format is not printable. The Binary data must be converted to ASCII format for printability. Consequently, no query terminators are used in Binary format.

Note: The only Acquisition Buffer query commands are the *Read Buffered Data* (R) commands **R1**, **R2**, and **R3**. Meanwhile, the only High/Low/Last (HLL) Register query commands are the *User Status* (U) commands **U4**, **U5**, and **U13**, and the *Read Last Readings* (R#) command.

Power-Up Configuration

The TempScan/1100 or MultiScan/1200 unit has an internally-stored factory-default configuration which can be recalled at any time. You can program the unit to power-up in a user-defined state, or if preferred, you can configure the unit to power-up with the default configuration.

During normal operations, the factory defaults may be recalled by issuing the *Restore Factory Defaults* (*F) command. When this command is processed, the TempScan/1100 or MultiScan/1200 will load the factory default configuration and will operate accordingly. However, this command may not be issued while an acquisition is currently configured.

The TempScan/1100 or MultiScan/1200 unit is normally configured to power up with the last known configuration at the time that it was powered down, or at the time that the *Reset Power-On* (*R) command is issued. However, the unit may be configured to always power-up either under the factory default configuration or under the last-known configuration, via the *Set Power-Up Configuration* (*S) command.

Note: Configuring the TempScan/1100 or MultiScan/1200 master unit to power up under the factory defaults or recalling the factory default settings will not affect pre-existing calibration factors of the master unit or its slave units.

The following list describes the execution steps and effects when the TempScan/1100 or MultiScan/1200 is configured to power up under the factory default configuration:

- **Step 1:** Q7,0,0,0,0. Using the *Set Query Terminator* (Q) command, set the general response terminator to CR-LF/EOI. Set all other terminators to **None**.
- **Step 2:** v0. Using the *Set User Terminator* (v) command, set the user terminator to ASCII hexadecimal value 00, or NUL.
- **Step 3:** F0,0. Using the *Set Data Format* (F) command, set the data format to Engineering Units, Degrees Celsius.
- **Step 4:** m0. Using the *Set SRQ Mask* (m) command, set the SRQ Mask to 000.
- **Step 5:** n0. Using the *Set Event Mask* (n) command, set the Event Status Enable Register (ESE) to 000.
- **Step 6:** *c. Using the *Clear Channel Configuration* (*c) command, clear all channel configurations.
- **Step 7:** y0,0,0. Using the *Set Counts* (y) command, set all acquisition counts to 0.
- **Step 8:** i00:00:00.0,00:00:00.0. Using the *Set Scan Interval* (i) command, set both timebase intervals to 0 seconds, or *fast mode*.
- **Step 9:** l1,0,0. Using the *Set Trigger Level* (l) command, clear the trigger level configurations.
- **Step 10:** t0,0,0,0. Using the *Set Trigger Configuration* (t) command, clear the acquisition trigger configurations.
- **Step 11:** m#0. MultiScan/1200 only. Using the *Set Measuring Mode* (m#) command, set the measuring mode to line-cycle integration/high-speed multi-channel mode.
- **Step 12:** F#20000.0. MultiScan/1200 only. Using the *Set Burst Mode Frequency* (F#) command, set the burst mode frequency to 20 kHz.
- **Step 13:** w#32. MultiScan/1200 only. Using the *Set Averaging Weight* (w#) command, set the sampling weight to 32.

For more information, see chapter *Power & Assembly*.

Acquisition Buffer	197
Buffer Organization.....	198
Buffer Query Operation.....	199
Buffer Read Operations.....	201
Buffer Overrun.....	207
High/Low/Last (HLL) Registers	209
Contents of the HLL Registers.....	209
Access to the HLL Registers.....	209
Comparing Buffered Data to HLL Data.....	214
Status-Reporting & Mask Registers	214
Theory of Operation.....	215
Status-Reporting Registers.....	216
Mask Registers.....	220
Using Status-Reporting Registers.....	220
Additional Operation	222
Trigger Latency.....	222
Real-Time Clock.....	222
Open Thermocouple & Range Error Checking.....	223
Software Digital Filtering (TempScan/1100 Only).....	223

Acquisition Buffer

The TempScan/1100 or MultiScan/1200 Acquisition Buffer is a FIFO (First-In First-Out) buffer. In other words, the oldest scan data to be written into the buffer is the first scan data to be read from the buffer when a read operation is performed. Then once the scan data is read from the buffer by the controller, that data is erased from the buffer.

The buffer may consist of one or more *Trigger Blocks*. In turn, a *Trigger Block* can consist of the following components as discussed in the previous chapter: *Pre-Trigger* scans (optional), *Post-Trigger* scans (required), and *Post-Stop* scans (optional). These components constitute a single *Trigger Block* in the internal memory of the TempScan/1100 or MultiScan/1200 unit. Each *Trigger Block* defines an acquisition and thus contains one and only one *Trigger* (trigger start event). These *Trigger Blocks* may also be variable in length.

Multiple *Trigger Blocks* are allocated sequentially, and the scans within each *Trigger Block* are written and read sequentially. It is not possible to randomly access a *Trigger Block* or a scan within a *Trigger Block*. When a read operation is performed, the scan that is read is the oldest scan in the oldest trigger block currently defined.

Buffer Organization

Single Trigger Block

Each *Trigger Block* in the buffer has an associated *Trigger Block* descriptor, used by internal processes for Acquisition Buffer maintenance. The management of this *Trigger Block* descriptor is totally user-transparent and, since the *Trigger Block* descriptor takes up memory, it will have an indirect affect on some user-defined processes. For instance, the *Buffer 75% Full* and the *Buffer Overrun* conditions will happen on a fewer number of scans as the trigger blocks increases.

A *Trigger Block* becomes defined when the configured *Trigger* (trigger start event) occurs. Once this start event occurs, the data within the *Trigger Block* (including any *Pre-Trigger* data) is available to be read (even though the *Trigger Block* may not yet be complete). Scan data is written then read to the *Trigger Block* in a FIFO fashion. As the controller requests written (or buffered) scan data, the TempScan/1100 or MultiScan/1200 unit supplies the oldest available scan data. After the scan data is supplied and read, that scan data is erased and is no longer available from the unit, and the Read Pointer automatically advances in the current *Trigger Block*. Consequently, the next scan data in the sequence, if acquired, now becomes the oldest available scan data. There is no mechanism to allow jumping around in the buffer or going back to a scan that had already been read by the controller.

Since scans are written into the *Trigger Block* sequentially, the *Trigger* scan may appear at any location within the *Trigger Block*. The TempScan/1100 or MultiScan/1200 will automatically convert these physical scan locations to logical scan locations where the *Trigger* scan is always oriented at location 0. The placement of the *Trigger* scan at the origin facilitates the quick interpretation of the Read Pointer and gives a frame of reference for other locations within the trigger block. If *Pre-Trigger* scans are configured, they will have logical scan locations defined by negative integers, whereas *Post-Trigger* scans will have logical scan locations defined by positive integers. All *Trigger Block* pointers are relative to the *Trigger* scan. From this point on, manual text discussions will assume references to logical *Trigger Blocks* only.

To retrieve the scan data after a *Trigger* has occurred, the TempScan/1100 or MultiScan/1200 provides multiple query functions. The *Read Buffered Data* (**R**) command provides the following queries: Read the oldest scan data in the Acquisition Buffer (**R1**), Read the oldest complete *Trigger Block* in the acquisition buffer (**R2**), and Read all of the scan data available in the Acquisition Buffer (**R3**). The following *User Status* (**U**) command query – Query the Buffer Status String (**U6**) – queries the current *Trigger Block* for a variety of information, including the current number of *Trigger Blocks* available in the buffer, and the current number of scans available in the buffer.

Multiple Trigger Blocks (Auto Re-arm)

Multiple *Trigger Blocks* are allocated sequentially, and the scans within each *Trigger Block* are written and read sequentially. Hence, after the last scan of the first *Trigger Block* is read by the controller, the first scan of the next *Trigger Block* will be read next. Through the *Auto Re-arm* capability, it is possible to capture more than one *Trigger Block* in the Acquisition Buffer of the TempScan/1100 or MultiScan/1200. The *Trigger* can only be re-armed after a *Trigger Block* has been completed and written. Each *Trigger Block* will contain one and only one *Trigger* (trigger start event).

If the *Auto Re-arm* feature is disabled, a *Set Trigger Configuration* (**T**) command must be issued to re-arm the TempScan/1100 or MultiScan/1200 for acquisition. To disable the *Auto Re-arm* feature, you must issue a *Set Trigger Configuration* (**T**) command with the **re-arm** flag set to zero.

If the *Auto-Rearm* feature is selected, another acquisition will take place on the next *Trigger* without any controller intervention. This allows the TempScan/1100 or MultiScan/1200 to store several acquisitions continuously in its buffer. The logical scan locations of the *Trigger* points, and their associated time stamps, can be found in the Buffer Status String. The Read Pointer is always on the oldest *Trigger Block*, so requests for Read Pointer status will always correspond to the *Trigger Block* available to be read. However, the next *Trigger* must be initiated after the previous acquisition has been completed and written. Otherwise, a *Trigger* overrun will occur.

Note: While armed, the *Auto Re-arm* feature does not allow you to change the acquisition configuration.

Buffer		
Read Pointer >	Scan -76	Pre-Trigger Scans
	Scan -75	
	Scan -74	
	...	
Trigger Scan >	Scan 000	Post-Trigger Scans
First Scan >	Scan 001	
	...	
	...	
	Scan 768	
	...	Post-Stop Scans
	Scan 1157	

Buffer		
No longer accessible	Scan -76	Pre-Trigger Scans
	Scan -75	
	Scan -74	
	...	
	Scan 000	Post-Trigger Scans
Scan 001		
...		
Read Pointer >	Scan 379	
	...	
	Scan 768	Post-Stop Scans
	...	
	Scan 1157	

The Read Pointer has advanced from the Pre-Trigger area (Scan -76) to the Post-Trigger area (Scan 379).

Single Trigger Block

Buffer		
No longer accessible	Scan -76	Trigger Block 1 Pre-Trigger Scans
	Scan -75	
	Scan -74	
	...	
	Scan 000	Trigger Block 1 Post-Trigger Scans
Scan 001		
...		
Scan 845		
Read Pointer >	Scan 1232	Trigger Block 1 Post-Stop Scans
	Scan 1233	
	Scan 1234	
Trigger Scan >	Scan -76	Trigger Block 2 Pre-Trigger Scans
	Scan -75	
	Scan -74	
	...	
	First Scan >	Scan 000
	Scan 001	
	...	
	Scan 678	
Trigger Scan >	Scan 822	Trigger Block 2 Post-Stop Scans
	Scan 823	
	Scan 824	

The Read Pointer has advanced into the Post-Stop area (Scan 1232) of the first Trigger Block.

Multiple Trigger Blocks

Trigger Block Configurations

Trigger Overrun

A *Trigger* overrun (as opposed to a buffer overrun) condition exists if more than one *Trigger* (trigger start event) or more than one *Stop* (trigger stop event) occurs during one *Trigger Block* acquisition. This condition is flagged and notification is given, but no other action is taken. The Trigger Overrun Bit (Bit 4) in the Error Source Register (**ESC**) is set. You may query the **ESC** via the *Query Error Status* (**E?**) command to determine if a *Trigger* overrun has occurred.

Buffer Query Operation

The Acquisition Buffer holds scan data that has been initiated by one or more *Triggers* (trigger start events), where each *Trigger Block* defines one acquisition and thus contains one and only one *Trigger* (trigger start event). These *Trigger Blocks* may also be variable in length.

The current status of the Acquisition Buffer may be interrogated at any time by issuing the following *User Status* (**U**) command query – Query the Buffer Status String (**U6**). As mentioned earlier, the **U6** command is a user query command which provides the interface in which the current Acquisition Buffer configuration may be queried, and which returns information regarding the current state of the Acquisition Buffer when issued.

The Query the Buffer Status String (U6) command returns the following fields:

- **Number of Trigger Blocks Available (Field 1).** Format: `xxxxxxxx`. This field represents the total number of *Trigger Blocks* currently contained within the Acquisition Buffer, at the time the U6 command was issued. The number of completed *Trigger Blocks* is not counted, but rather the number of detected *Triggers* is counted. If there are no *Trigger Blocks* available, then this field will have the value `0000000`.
- **Number of Scans Available (Field 2).** Format: `xxxxxxxx`. This field represents the total number of scans available across all *Trigger Blocks* in the Acquisition Buffer, at the time the U6 command was issued. It should be noted that *Pre-Trigger* data is not available to you until the defined *Trigger* has occurred. If there are no scans available in the buffer, then this field will have the value `0000000`.
- **Current Position of Read Pointer (Field 3).** Format: `±xxxxxxxx`. This field represents the current read location within the currently-read *Trigger Block*. This Read Pointer is relative to the *Trigger* scan point, which is always oriented at logical scan location 0. If the *Trigger* scan is currently being read, then the Read Pointer will have the value `0000000`. If *Pre-Trigger* scans are currently being read, the Read Pointer will have a negative integer value. Likewise, if *Post-Trigger* scans are currently being read, the Read Pointer will have a positive integer value. If the Read Pointer is undefined at the time the U6 command was issued, then its value will be `-0999999`.
- **Time/Date Stamping of Trigger Event (Field 4).** Absolute ASCII format: `hh:mm:ss.mil,MM/DD/YY`. Relative ASCII format: `+hh:mm:ss.mil,DDDDDD`. Absolute Binary format: `hmstuvwMDY`. Absolute Binary format: `hmstuvwDEF`. This field represents the absolute or relative Time/Date value when the *Trigger* event occurred for the currently-read *Trigger Block*. If the *Trigger* event has not yet occurred at the time the U6 command was issued, then this field will have the following value:
 - Absolute ASCII value `00:00:00.00,00/00/00`,
 - Relative ASCII value `+00:00:00.00,0000000`,
 - Absolute Binary value `00 00 00 00000000 00 00 00` (2-2-2-8-2-2-2 digits), or
 - Relative Binary value: `00 00 00 00000000 000000` (2-2-2-8-6 digits).
- **Position of Stop Event Pointer (Field 5).** Format: `±xxxxxxxx`. This field represents the *Stop* event location within the currently-read *Trigger Block*. This Read Pointer is relative to the *Trigger* scan point, which is always oriented at logical scan location 0. Since the *Stop* event must always occur after the *Trigger* event, this Read Pointer will always have a positive integer value. If the *Stop* event has not yet occurred at the time the U6 command was issued, this field will have the undefined value `-0999999`.
- **Time/Date Stamping of Stop Event (Field 6).** Absolute ASCII format: `hh:mm:ss.mil,MM/DD/YY`. Relative ASCII format: `+hh:mm:ss.mil,DDDDDD`. Absolute Binary format: `hmstuvwMDY`. Absolute Binary format: `hmstuvwDEF`. This field represents the absolute or relative Time/Date value when the *Stop* event occurred for the currently-read *Trigger Block*. If the *Stop* event has not yet occurred at the time the U6 command was issued, this field will have the following value:
 - Absolute ASCII value `00:00:00.00,00/00/00`,
 - Relative ASCII value `+00:00:00.00,0000000`,
 - Absolute Binary value `00 00 00 00000000 00 00 00` (2-2-2-8-2-2-2 digits), or
 - Relative Binary value: `00 00 00 00000000 000000` (2-2-2-8-6 digits).
- **Position of End Scan Pointer (Field 7).** Format: `±xxxxxxxx`. This field represents the End scan location in the currently-read *Trigger Block*. This Read Pointer is relative to the *Trigger* scan point, which is always oriented at logical scan location 0. Since the End scan must always occur after the *Trigger* event, this Read Pointer will always have a positive integer value. If the End scan has not yet occurred at the time the U6 command was issued, this field will have the undefined value of `-0999999`.

This field will always have the same value as the *Position of Stop Event Pointer* field unless *Post-Stop* scans have been configured; that is, if the *Post-Stop stop* parameter of the *Set Counts (Y)* command has been set to a non-zero value. In this case, this *Position of End Scan Pointer* field will have a greater value than the *Position of Stop Event Pointer* field.

- **Status of Current Trigger Block (Field 8).** Format: **xx**. This field represents the status of the currently-read *Trigger Block*. If the currently-read *Trigger Block* is still being acquired, then this field will have the value **00**. If the currently-read *Trigger Block* has been completely acquired and has terminated normally, then this field will have the value **01**. However, if the currently-read *Trigger Block* has prematurely terminated (due to user intervention), then this field will have the value **02**.

It should be noted that *Trigger Blocks* are not assigned a *Trigger Block* number as such. These *Trigger Block* numbers refer to locations relative to the currently-read *Trigger Block*. Consequently, the *Trigger Block* currently being read is always *Trigger Block 1*. Meanwhile, the *Trigger Block* currently being written is always the value of the *Number of Trigger Blocks Available* field.

Buffer Read Operations

As mentioned earlier, the TempScan/1100 or MultiScan/1200 Acquisition Buffer is a FIFO (First-In First-Out) buffer. In other words, the oldest scan data to be written into the buffer is the first scan data to be read from the buffer when a read operation is performed. Then once the scan data is read from the buffer by the controller, that data is erased from the buffer.

The Acquisition Buffer data is read via the *Read Buffered Data (R)* command. You can use this command to read anywhere from one scan to all the scan data currently residing in the buffer. This command has the following valid options:

- Read the oldest scan currently residing in the Acquisition Buffer (**R1**).
- Read the oldest complete *Trigger Block* currently residing in the Acquisition Buffer (**R2**).
- Read all the scan data currently residing in the Acquisition Buffer (**R3**).

When a *Read Buffered Data (R)* command is issued, the TempScan/1100 or MultiScan/1200 checks to see if the read request can be fulfilled. If so, the requested scan data is moved from the Acquisition Buffer to the Output Queue where it waits until the controller initiates transfer. However, if either of the following is true – No channels are configured, or the amount of scan data requested is not available – then the read request will not be fulfilled, and a *Conflict Error* will be posted. The **R1** and **R3** commands require that at least one scan be available, and the **R2** command requires that at least one complete *Trigger Block* be available.

The Scan Available Bit (Bit 3) in the Status Byte Register (**STB**) can be used to determine whether or not the Acquisition Buffer is empty. This bit is set when at least one scan is available in the buffer. The following *User Status (U)* command query – Query the Buffer Status String (**U6**) – may also be used to retrieve more-detailed information about the state of the Acquisition Buffer.

Note: The responses to all queries (including **U6**, **R1**, and **R2**) can be configured with specific field separators and response terminators. For details on setting query terminators, see command *Set Query Terminator (Q)* in the chapter *API Command Reference*.

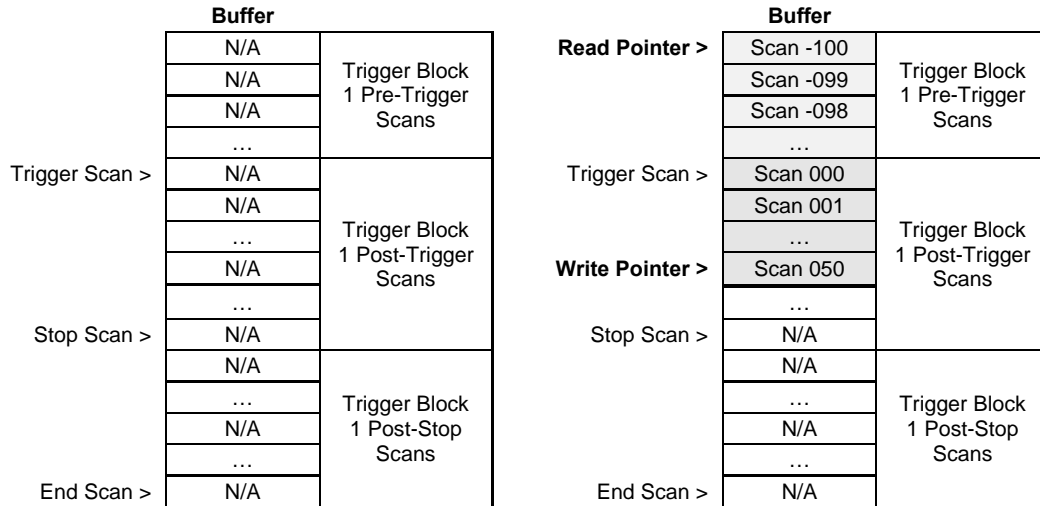

(1) The Acquisition Buffer is empty.

(2) The Stop event has not yet occurred.

Part 1 The Acquisition Buffer is empty. The following describes a Query the Buffer Status String (U6) response when the Acquisition Buffer is empty. The Time/Data stamping is in absolute ASCII format.

```
0000000,0000000,-0999999,00:00:00.000,00/00/00,-0999999,00:00:00.000,
00/00/00,-0999999,00
```

Field	Field Name	Buffer Status String Response	Response Description
1	Number of Trigger Blocks Available	0000000	Zero
2	Number of Scans Available	0000000	Zero
3	Current Position of Read Pointer	-0999999	Undefined
4	Time/Date Stamping of Trigger Event	00:00:00.000,00/00/00	Absolute ASCII format
5	Position of Stop Event Pointer	-0999999	Undefined
6	Time/Date Stamping of Stop Event	00:00:00.000,00/00/00	Absolute ASCII format
7	Position of End Scan Pointer	-0999999	Undefined
8	Status of Current Trigger Block	00	Not being acquired

Part 2 The Stop event has not yet occurred. The following describes a U6 response when the Trigger event has occurred but the Stop event has not yet occurred. The Current Position of Read Pointer field has the value of the first available Pre-Trigger scan -100, and an additional 50 Post-Trigger scans are available. The Time/Data stamping is in absolute ASCII format.

```
0000001,0000151,-0000100,12:01:43.100,08/29/96,-0999999,00:00:00.000,
00/00/00,-0999999,00
```

Field	Field Name	Buffer Status String Response	Response Description
1	Number of Trigger Blocks Available	0000001	One
2	Number of Scans Available	0000151	100 + 1 + 50
3	Current Position of Read Pointer	-0000100	Pre-Trigger Scan -100
4	Time/Date Stamping of Trigger Event	12:01:43.100,08/29/96	Absolute ASCII format
5	Position of Stop Event Pointer	-0999999	Undefined
6	Time/Date Stamping of Stop Event	00:00:00.000,00/00/00	Absolute ASCII format
7	Position of End Scan Pointer	-0999999	Undefined
8	Status of Current Trigger Block	00	Still being acquired

Query (U6) Buffer Operation Single Trigger Block, Parts 1 & 2 (of 4)

Buffer		
Read Pointer >	Scan -100	Trigger Block 1 Pre-Trigger Scans
	Scan -099	
	Scan -098	
	...	
Trigger Scan >	Scan 000	Trigger Block 1 Post-Trigger Scans
	Scan 001	
	...	
	Scan 050	
	...	
Stop Scan >	Scan 100	Trigger Block 1 Post-Stop Scans
	Scan 101	
	...	
Write Pointer >	Scan 150	Trigger Block 1 Post-Stop Scans
	...	
End Scan >	N/A	

(3) The End scan has not yet occurred.

Buffer		
Read Pointer >	Scan -100	Trigger Block 1 Pre-Trigger Scans
	Scan -099	
	Scan -098	
	...	
Trigger Scan >	Scan 000	Trigger Block 1 Post-Trigger Scans
	Scan 001	
	...	
	Scan 050	
	...	
Stop Scan >	Scan 100	Trigger Block 1 Post-Stop Scans
	Scan 101	
	...	
Write Pointer >	Scan 150	Trigger Block 1 Post-Stop Scans
	...	
End Scan >	Scan 250	

(4) The Trigger Block is now complete.

Part 3 The End scan has not yet occurred. The following describes a U6 response when the *Trigger* event has occurred, the *Stop* event has also occurred, but the *End scan* has not yet occurred. The *Current Position of Read Pointer* field has the same value of the first available *Pre-Trigger* scan -100, but now an additional 100 *Post-Trigger* scans plus 50 *Post-Stop* scans are available. The Time/Data stamping is in absolute ASCII format.

0000001,0000251,-0000100,12:01:43.100,08/29/96,0000100,12:25:01.300,
08/29/96,-0999999,00

Field	Field Name	Buffer Status String Response	Response Description
1	Number of Trigger Blocks Available	0000001	One
2	Number of Scans Available	0000251	100 + 1 + 100 + 50
3	Current Position of Read Pointer	-0000100	Pre-Trigger Scan -100
4	Time/Date Stamping of Trigger Event	12:01:43.100,08/29/96	Absolute ASCII format
5	Position of Stop Event Pointer	0000100	Post-Trigger Scan 100
6	Time/Date Stamping of Stop Event	12:25:01.300,08/29/96	Absolute ASCII format
7	Position of End Scan Pointer	-0999999	Undefined
8	Status of Current Trigger Block	00	Still being acquired

Part 4 The Trigger Block is now complete. The following describes a U6 response when the *Trigger* event has occurred, the *Stop* event has also occurred, and the *End scan* has also occurred. The *Current Position of Read Pointer* field has the same value of the first available *Pre-Trigger* scan -100, and an additional 100 *Post-Trigger* scans plus 150 *Post-Stop* scans are available. The *Trigger Block* is now complete. The Time/Data stamping is in absolute ASCII format.

0000001,0000351,-0000100,12:01:43.100,08/29/96,0000100,12:25:01.300,
08/29/96,0000250,01

Field	Field Name	Buffer Status String Response	Response Description
1	Number of Trigger Blocks Available	0000001	One
2	Number of Scans Available	0000351	100 + 1 + 100 + 150
3	Current Position of Read Pointer	-0000100	Pre-Trigger Scan -100
4	Time/Date Stamping of Trigger Event	12:01:43.100,08/29/96	Absolute ASCII format
5	Position of Stop Event Pointer	0000100	Post-Trigger Scan 100
6	Time/Date Stamping of Stop Event	12:25:01.300,08/29/96	Absolute ASCII format
7	Position of End Scan Pointer	0000250	Post-Trigger Scan 250
8	Status of Current Trigger Block	01	Acquisition complete

Query (U6) Buffer Operation Single Trigger Block, Parts 3 & 4 (of 4)

Buffer			Buffer		
	Empty		Empty		
Read Pointer >	Scan -100	Trigger Block 1 Pre-Trigger Scans	Not accessible	Scan -100	Trigger Block 1 Pre-Trigger Scans
	Scan -099		Read Pointer >	Scan -099	
	
Trigger Scan >	Scan 000	Trigger Block 1 Post-Trigger Scans	Trigger Scan >	Scan 000	Trigger Block 1 Post-Trigger Scans
	Scan 001			Scan 001	
	
Stop Scan >	Scan 1004	Trigger Block 1 Post-Stop Scans	Stop Scan >	Scan 1004	Trigger Block 1 Post-Stop Scans
	Scan 1005			Scan 1005	
	
End Scan >	Scan 1254	Trigger Blocks 2 through 6	End Scan >	Scan 1254	Trigger Blocks 2 through 6
	Block 2			Block 2	
	Block 3			Block 3	
	Block 4			Block 4	
	Block 5			Block 5	
Scan 20216 >	Block 6			Block 6	

(1) The current Acquisition Buffer status.

(2) The oldest scan in the Acquisition Buffer has been read.

Part 1 The current Acquisition Buffer status. The Acquisition Buffer currently contains 6 available *Trigger Blocks*, and 20216 available scans.

Part 2 The oldest scan in the Acquisition Buffer has been read. The program example demonstrates how the **R1** command will read the oldest scan currently residing in the buffer.

```
(1) PRINT#1, "OUTPUT07;U6X"
(2) PRINT#1, "ENTER07"
(3) INPUT A$
      0000006,0020216,-0000100,12:51:43.100,03/24/97,0001004,
      13:53:01.300,03/24/97,0001254,01
(4) PRINT#1, "OUTPUT07;R1X"
(5) PRINT#1, "ENTER07"
(6) INPUT A$
      +0234.20 -0019.40 +0001.40 +0023.60
(7) PRINT#1, "OUTPUT07;U6X"
(8) PRINT#1, "ENTER07"
(9) INPUT A$
      0000006,0020215,-0000099,12:51:43.100,03/24/97,0001004,
      13:53:01.300,03/24/97,0001254,01
```

- **Line 1:** Request the current status of the Acquisition Buffer.
- **Line 2:** Retrieve the status.
- **Line 3:** The screen will show the current status of the Acquisition Buffer.

Before the scan is read, the Buffer Status String response indicates that the total number of *Trigger Blocks* available in the buffer is 6 (7-1), and the total number of scans available in the buffer is 20216 (20567-351), where the previous *Trigger Block* of 351 scans has already been read out and erased (now empty). Furthermore, it shows that the current location of the Read Pointer is at *Pre-Trigger* scan -100 in the current *Trigger Block*. This particular scan can be retrieved as follows:

- **Line 4:** Get the oldest scan.
- **Line 5:** Get the response.
- **Line 6:** The screen will show the single-scan data for each of the four (4) configured channels.
- **Line 7:** Now, get the current status of the Acquisition Buffer.
- **Line 8:** Get the response.
- **Line 9:** The screen will show the new current status of the Acquisition Buffer.

Notice that after the scan is read, there are now 20215 (20216-1) scans available in the buffer and the current location of the Read Pointer is at *Pre-Trigger* scan -099.

Read (R1) Buffer Operation Multiple Trigger Blocks, Parts 1 & 2 (of 4)

Buffer	
	Empty
	Empty
Read Pointer >	Scan -100
	Scan -099
	...
Trigger Scan >	Scan 000
	Scan 001
	...
Stop Scan >	Scan 400
	Scan 401
	...
End Scan >	Scan 650
	Block 2
	Block 3
	Block 4
Scan 18660 >	Block 5

(3) The oldest complete Trigger Block in the Acquisition Buffer has been read.

Part 3 The oldest complete Trigger Block in the Acquisition Buffer has been read. The program example demonstrates how the R2 command will read the oldest complete *Trigger Block* currently residing in the buffer.

```
(1) PRINT#1, "OUTPUT07;U6X"
(2) PRINT#1, "ENTER07"
(3) INPUT A$
      0000006,0020215,-0000099,12:51:43.100,03/24/97,0001004,
      13:53:01.300,03/24/97,0001254,01

(4) PRINT#1, "OUTPUT07;R2X"
(5) PRINT#1, "ENTER07"
(6) INPUT A$
      +0234.20 -0019.40 +0001.40 +0023.60...(etc)...
```

```
(7) PRINT#1, "OUTPUT07;U6X"
(8) PRINT#1, "ENTER07"
(9) INPUT A$
      0000005,0018660,-0000100,02:15:34.100,03/24/97,0000400,
      04:51:10.300,03/24/97,0000650,01
```

- **Line 1:** Request the current status of the Acquisition Buffer.
- **Line 2:** Retrieve the status.
- **Line 3:** The screen will show the current status of the Acquisition Buffer.

Before the *Trigger Block* is read, the Buffer Status String response indicates that the total number of *Trigger Blocks* available in the buffer is still 6, and the total number of scans available in the buffer is 20215 (20216-1). Furthermore, it shows that the current location of the Read Pointer is at *Pre-Trigger* scan -099 in the first *Trigger Block*. This particular *Trigger Block* can be retrieved as follows:

- **Line 4:** Get the oldest complete *Trigger Block*.
- **Line 5:** Get the response.
- **Line 6:** The screen will show the 1355 scans of data for each of the four (4) configured channels.
- **Line 7:** Now, get the current status of the Acquisition Buffer.
- **Line 8:** Get the response.
- **Line 9:** The screen will show the new current status of the Acquisition Buffer.

Notice that after the *Trigger Block* is read, there are now 5 (6-1) *Trigger Blocks* and 18860 (20215-1355) scans available in the buffer, and the current location of the Read Pointer is at *Pre-Trigger* scan -100 of the next current *Trigger Block*. In addition, the following information has been updated to reflect this current *Trigger Block*: The Time/Date stamping of the *Trigger* and *Stop* events, and the current locations of the Stop Event Pointer and End Scan Pointer are now at *Post-Trigger* scans 400 and 650, respectively.

Read (R2) Buffer Operation Multiple Trigger Blocks, Part 3 (of 4)

Buffer
Empty
Empty
Empty
Empty
Empty
Empty
Empty

(4) All of the scan data in the Acquisition Buffer has been read. The buffer is now empty.

Part 4 The oldest complete Trigger Block currently in the Acquisition Buffer has been read. The program example demonstrates how the R3 command will read all of the scan data currently residing in the buffer.

```
(1) PRINT#1, "OUTPUT07;U6X"
(2) PRINT#1, "ENTER07"
(3) INPUT A$
      0000005,0018660,-0000100,02:15:34.100,03/24/97,0000400,
      04:51:10.300,03/24/97,0000650,01

(4) PRINT#1, "OUTPUT07;R3X"
(5) PRINT#1, "ENTER07"
(6) INPUT A$
      +0234.20 -0019.40 +0001.40 +0023.60...(etc)...

(7) PRINT#1, "OUTPUT07;U6X"
(8) PRINT#1, "ENTER07"
(9) INPUT A$
      0000000,0000000,-0999999,00:00:00.000,00/00/00,-0999999,
      00:00:00.000,00/00/00,-0999999,00
```

- **Line 1:** Request the current status of the Acquisition Buffer.
- **Line 2:** Retrieve the status.
- **Line 3:** The screen will show the current status of the Acquisition Buffer.

Before all of the scan data is read, the Buffer Status String response indicates that the total number of *Trigger Blocks* available in the buffer is 5, and the total number of scans available in the buffer is 18860 (20215-1355). Furthermore, it shows that the current location of the Read Pointer is at *Pre-Trigger* scan -100 in the first *Trigger Block*. All of the scan data can be retrieved as follows:

- **Line 4:** Get all of the scan data in the Acquisition Buffer.
- **Line 5:** Get the response.
- **Line 6:** The screen will show all 18860 scans of data for each of the four (4) configured channels.
- **Line 7:** Now, get the current status of the Acquisition Buffer.
- **Line 8:** Get the response.
- **Line 9:** The screen will show the new current status of the Acquisition Buffer.

Notice that after all of the scan data is read, the Acquisition Buffer is now complete empty.

Read (R3) Buffer Operation Multiple Trigger Blocks, Part 4 (of 4)

Buffer Overrun

The TempScan/1100 or MultiScan/1200 Acquisition Buffer will wrap around on itself if the controlling computer cannot read the data out fast enough before the buffer gets completely full. This situation is called *buffer overrun* (as opposed to a *Trigger overrun*). Although this situation prevents new data from being lost and keeps the scan rate consistent, it also overwrites the oldest data.

A buffer overrun is registered as an error. However, in some applications, a buffer overrun may be a part of normal operation. For example, if a TempScan/1100 with 256 Kbytes of memory was configured to scan 16 channels at a one minute interval, the buffer would get completely full and an overrun would occur in about 5.6 days. Regardless of how long the TempScan/1100 is left unattended after that point, it will always maintain the newest 5.6 days of scan data.

There are two cases of buffer overrun as follows:

- When the Acquisition Buffer contains a single *Trigger Block*.
- When the Acquisition Buffer contains multiple *Trigger Blocks*.

If a buffer overrun occurs, it may be detected by querying the Status Byte Register (**STB**) via either of the following commands:

- **SPOLL**: Serial Poll command. For IEEE 488 interfaces only.

```
PRINT#1, "SPOLL 07"  
INPUT #2, S%  
IF (S% and 128 = 128) THEN  
    PRINT "Buffer Overrun Occurred"  
ENDIF
```
- **U1**: *User Status (U1)* command. For both IEEE 488 and RS-232/RS-422 interfaces.

```
PRINT#1, "OUTPUT07; U1X"  
PRINT#1, "ENTER07"  
INPUT #2, S%  
IF (S% and 128 = 128) THEN  
    PRINT "Buffer Overrun Occurred"  
ENDIF
```

Buffer Overrun With One Trigger Block

When only one *Trigger Block* is in the Acquisition Buffer, a buffer overrun will erase the entire *Pre-Trigger* area. If *Pre-Trigger* scans were being read when the buffer overrun occurred, the *Trigger* scan will be the next scan read from the buffer.

However, if no *Pre-Trigger* scans were configured or the *Pre-Trigger* has already been read, a buffer overrun will only erase the oldest *Post-Trigger* scan in the buffer. If the scan being erased is currently being read, the contents of the read scan will be in error.

If the controller detects a buffer overrun condition during a read operation, any further reading will be considered corrupt until a buffer reset is issued. This buffer reset can be done via the *Flush Acquisition Buffer* (***B**) command or reading the remaining data out of the buffer until it is clear.

Buffer Overrun With Multiple Trigger Blocks

When more than one *Trigger Block* is in the Acquisition Buffer, a buffer overrun will erase the oldest complete *Trigger Block*. If the *Trigger Block* being erased is currently being read, that *Trigger Block* read will be terminated and the Read Pointer will be advanced to the start of the next *Trigger Block*.

If the controller detects a buffer overrun condition during a read operation, any further reading will be considered corrupt until a buffer reset is issued. This buffer reset can be done via the *Flush Acquisition Buffer* (***B**) command or reading the remaining data out of the buffer until it is clear.

Buffer		
Read Pointer >	Scan -50	Pre-Trigger Scans
	Scan -49	
	Scan -48	
	...	
Write Pointer >	Scan 000	Post-Trigger Scans
	...	
	Scan 252	
	...	
	Scan 450	
	...	
	N/A	
End of Buffer >	...	Post-Stop Scans
	N/A	

(1) The Write Pointer advances as scans are collected while the Read Pointer advances as scans are read from the buffer.

Buffer		
Write Pointer >	Scan 751	Post-Stop Scans
	Scan 752	
	N/A	
No longer accessible	Scan 000	Post-Trigger Scans
	...	
Read Pointer >	Scan 252	
	...	
	Scan 450	
	...	
End of Buffer >	Scan 500	
	...	
	Scan 750	

(2) After 302 scans, the Read Pointer has advanced to Scan 252 while the Write Pointer has advanced to Scan 752 (returning to the start of the buffer and erasing the entire Pre-Trigger area).

Buffer Overrun Single Trigger Block With Pre-Trigger Area

Buffer		
Read Pointer >	Scan 000	Post-Trigger Scans
	Scan 001	
	Scan 002	
	...	
Write Pointer >	Scan 252	Post-Trigger Scans
	...	
	Scan 352	
	...	
End of Buffer >	N/A	Post-Stop Scans
	...	
	N/A	

(1) The Write Pointer advances as scans are collected while the Read Pointer advances as scans are read from the buffer.

Buffer		
Write Pointer >	Scan 601	Post-Stop Scans
	Scan 602	
No longer accessible	Scan 002	Post-Trigger Scans
	...	
Read Pointer >	Scan 252	
	...	
	Scan 352	
	...	
End of Buffer >	Scan 450	
	...	
	Scan 600	

(2) After 250 scans, the Read Pointer has advanced to Scan 252 while the Write Pointer has advanced to Scan 602 (returning to the start of the buffer and erasing one Post-Trigger scan at a time).

Buffer Overrun Single Trigger Block Without Pre-Trigger Area

Buffer		
Read Pointer >	Block 1	Trigger Blocks 1 through 5
	Block 2	
	Block 3	
	Block 4	
Write Pointer >	Block 5	Trigger Blocks 1 through 5
	N/A	
End of Buffer >	N/A	

(1) The Write Pointer advances as scans are collected while the Read Pointer advances as scans are read from the buffer.

Buffer		
Write Pointer >	Block 1 to 7	Trigger Blocks 2 through 7 renumbered to 1 through 6
	No longer accessible	
Read Pointer >	Block 2 to 1	
	Block 3 to 2	
	Block 4 to 3	
	Block 5 to 4	
End of Buffer >	Block 6 to 5	
	Block 7 to 6	

(2) After 3 Trigger Blocks, the Read Pointer has advanced to Block 4 while the Write Pointer has advanced to the start of the buffer (erasing the oldest Trigger Block and renumbering the Blocks).

Buffer Overrun Multiple Trigger Blocks

High/Low/Last (HLL) Registers

Other than reading the Acquisition Buffer, accessing the High/Low/Last (HLL) Registers is an alternative method of getting channel data from the TempScan/1100 or MultiScan/1200 system. Independent of the triggering and scan-interval configuration for an acquisition, the HLL Registers are constantly updated with new values during the acquisition, at the following rates: At the maximum scan rate, for the TempScan/1100; and at any current programmed scan rate up to the maximum scan rate, for the MultiScan/1200. At any time, the HLL Registers can be queried for channel values without affecting the buffered data.

The minimum requirement for activating the HLL Registers is to configure the desired channel(s) in the scan, using the *Configure Channels* (C) command. Those channels not included in the channel scan do not have to be configured. Meanwhile, the returned scan data will be in the desired data format – Engineering Units, Binary, or ASCII Counts – that you have defined, using the *Set Data Format* (F) command.

Contents of the HLL Registers

The High/Low/Last (HLL) Registers contain and return, when requested, the following information for each configured channel:

- The High Reading for the channel since the beginning of the current acquisition or since the last HLL query – Query and clear the current High/Low/Last (U5).
- The Time/Date Stamping of the High Reading.
- The Low Reading for the channel since the beginning of the current acquisition or since the last HLL query – Query and clear the current High/Low/Last (U5).
- The Time/Date Stamping for the Low Reading.
- The Last or most recent Reading for the channel.

To initiate HLL updating it is only necessary to configure the desired channel(s). The HLL Registers will only be updated for those channels configured, and you may only access the HLL Registers for the configured channels. You can clear the High and Low readings for each configured channel in any of the following ways:

- Powering on the TempScan/1100 or MultiScan/1200.
- Issuing a new channel configuration.
- Clearing the readings explicitly by command (as discussed in the following text).

Note: When the High and Low values are cleared, their associated Time/Date Stamps are also cleared. After being cleared, the new High and Low values (along with their associated Time/Date Stamping) will be initialized on the next updating of the HLL Registers.

Access to the HLL Registers

You can access the HLL Registers of the TempScan/1100 or MultiScan/1200 unit via commands issued by the PC/IEEE 488 controller. That is, you can use these commands to access any or all of the channel-data contents of the HLL Registers, as well as to clear the High and Low readings along with their associated Time/Date Stamping.

The commands which can initiate the output of channel data (in Engineering Units, Binary, or ASCII Counts format) specifically from the HLL Registers are the *Read Last Readings* (R#) command, and the following *User Status* (U) command queries: Query current HLL Registers (U4), Query and clear current HLL Registers (U5) and Query last scan read (U13).

As you can see, two queries are available to read the HLL Registers: **U4** and **U5**. The **U4** command requests the HLL data, maintaining the High and Low values, while the **U5** command requests then clears the HLL data, resetting the High and Low values to the Last value.

All HLL data will be sent to the controller as dictated by the scan configuration and data format which you have defined. You can use the *Set Query Terminator* (**Q**) command to specify a response terminator separating each channel of the HLL data, and the *Set Data Format* (**F**) command to specify the output format of the HLL data.

Example 13a. Query Current HLL Registers (U4) with HLL Terminator

```
(1) PRINT#1, "OUTPUT07;F0,0 Q1,1,0,0,0X"
(2) PRINT#1, "OUTPUT07;C1-2,1 C10,1 C15,1X"
(3) (Command lines to configure and start an acquisition.)
(4) PRINT#1, "OUTPUT07;U4X"
(5) PRINT#1, "ENTER07"
(6) INPUT A$
      +1450.20 S 12:23:21.700,03/24/97
      +0850.20 S 12:35:09.300,03/24/97, +0950.30
(7) PRINT#1, "ENTER07"
(8) INPUT A$
      +0450.20 S 02:00:29.500,03/24/97
      +0057.60 S 10:35:00.400,03/24/97, +0250.60
(9) PRINT#1, "ENTER07"
(10) INPUT A$
      -0045.50 S 11:03:51.700,03/24/97
      -0110.10 S 12:55:09.100,03/24/97, -0050.80
(11) PRINT#1, "ENTER07"
(12) INPUT A$
      +0150.70 S 03:39:01.200,03/24/97
      -0085.20 S 05:25:17.300,03/24/97, +0010.90
```

The above example demonstrates how to configure and query all the HLL Registers, and how the HLL terminator can be used to control the flow of the HLL response output. Notice that only those channels configured – 1, 2, 10 and 15 – are returned in the response.

- **Line 1:** Set the data format to Degrees Celsius (°C) with HLL terminator of CR LF / EOI.
- **Line 2:** Configure four channels – 1, 2, 10 and 15.
- **Line 3:** Provide the appropriate command lines to configure and start an acquisition.
- **Line 4:** After an indiscriminate amount of time, query the current HLL settings.
- **Line 5:** Get the response.
- **Line 6:** The screen will show the Channel 1 scan data in the HLL Registers.
- **Line 7:** Get the next response.
- **Line 8:** The screen will show the Channel 2 scan data in the HLL Registers.
- **Line 9:** Get the next response.
- **Line 10:** The screen will show the Channel 10 scan data in the HLL Registers.
- **Line 11:** Get the next response.
- **Line 12:** The screen will show the Channel 15 scan data in the HLL Registers.

Example 13b. Query & Clear Current HLL Registers (U5) with No HLL Terminator

```
(1) PRINT#1, "OUTPUT07;F0,0X Q1,0,0,0,0X"
(2) PRINT#1, "OUTPUT07;C1-4,1X"
(3) (Command lines to configure and start an acquisition.)
(4) PRINT#1, "OUTPUT07;U5X"
(5) PRINT#1, "ENTER07"
(6) INPUT A$
      +1450.20 S 12:23:21.700,03/24/97
      +0850.20 S 12:35:09.300,03/24/97, +0950.30
      +0450.20 S 02:00:29.500,03/24/97
      +0057.60 S 10:35:00.400,03/24/97, +0250.60
      +0045.50 S 11:03:51.700,03/24/97
      -0110.10 S 12:55:09.100,03/24/97, -0050.80
      +0150.70 S 03:39:01.200,03/24/97
      -0085.20 S 05:25:17.300,03/24/97, +0010.90
(7) PRINT#1, "OUTPUT07;S?X"
(8) PRINT#1, "ENTER07"
(9) INPUT A$
      S 13:20:00.100,03/24/97
(10) PRINT#1, "OUTPUT07;U4X"
(11) PRINT#1, "ENTER07"
(12) INPUT A$
      +0980.20 S 13:20:01.700,03/24/97
      +0959.20S13:20:09.300,03/24/97, +0975.80
      +0260.70 S 13:20:29.500,03/24/97
      +0245.60S13:20:00.400,03/24/97, +0257.60
      -0047.50 S 13:20:51.700,03/24/97
      -0051.10S13:20:09.100,03/24/97, -0049.80
      +0015.70 S 13:20:01.200,03/24/97
      +0008.20S13:20:17.300,03/24/97, +0010.40
```

The next example demonstrates how to reset the High and Low values along with their associated Time/Date Stamps. It also shows the effect of specifying no HLL terminator; only one **ENTER** command returns all of the HLL data.

- **Line 1:** Set the data format to Degrees Celsius (°C) with HLL terminator of **None**.
- **Line 2:** Configure four channels – 1, 2, 3, and 4.
- **Line 3:** Provide the appropriate command lines to configure and start an acquisition.
- **Line 4:** After an indiscriminate amount of time, query and then reset the current HLL settings.
- **Line 5:** Get the response.
- **Line 6:** The screen will show the scan data for Channels 1 through 4 in the HLL Registers. Notice that only one **ENTER** command returned all of the HLL data.
- **Line 7:** Now get the current time.
- **Line 8:** Get the response.
- **Line 9:** The screen will show the current time.
- **Line 10:** Now again, query (but do not reset) the HLL settings.
- **Line 11:** Get the response.
- **Line 12:** The screen will show the reset HLL data.

Example 13c. Query Last Scan Reading (U13) with Celsius & HLL Terminator

```
(1) PRINT#1, "OUTPUT07;F0,0 Q1,1,0,0,0X"  
(2) PRINT#1, "OUTPUT07;C1-4,1X"  
(3) (Command lines to configure and start an acquisition.)  
(4) PRINT#1, "OUTPUT07;U13X"  
(5) PRINT#1, "ENTER07"  
(6) INPUT A$  
      +0950.30  
(7) PRINT#1, "ENTER07"  
(8) INPUT A$  
      +0250.60  
(9) PRINT#1, "ENTER07"  
(10) INPUT A$  
      -0050.80  
(11) PRINT#1, "ENTER07"  
(12) INPUT A$  
      +0010.90
```

The next example demonstrates how to read only the Last readings. Notice that since a HLL response terminator was specified, the Last reading for each channel had to be entered separately.

- **Line 1:** Set the data format to Degrees Celsius ($^{\circ}C$) with HLL terminator of CR LF / EOI.
- **Line 2:** Configure four channels – 1, 2, 3, and 4 – with no setpoints.
- **Line 3:** Provide the appropriate command lines to configure and start an acquisition.
- **Line 4:** After an indiscriminate amount of time, query the Last channel readings.
- **Line 5:** Get the response.
- **Line 6:** The screen will show the Last reading for Channel 1.
- **Line 7:** Get the next response.
- **Line 8:** The screen will show the Last reading for Channel 2.
- **Line 9:** Get the next response.
- **Line 10:** The screen will show the Last reading for Channel 3.
- **Line 11:** Get the next response.
- **Line 12:** The screen will show the Last reading for Channel 4.

Example 13d. Query Last Scan Reading (U13) with Fahrenheit & No HLL Terminator

```
(1) PRINT#1, "OUTPUT07;F1,0X Q1,0,0,0,0X"  
(2) PRINT#1, "OUTPUT07;C1-4,1X"  
(3) (Command lines to configure and start an acquisition.)  
(4) PRINT#1, "OUTPUT07;U13X"  
(5) PRINT#1, "ENTER07"  
(6) INPUT A$  
      +1743.08 +0483.08 -0059.44 +0051.62
```

The next example also demonstrates how to read only the Last readings. But in this case, no HLL response terminators are specified and the format has been changed to Degrees Fahrenheit ($^{\circ}F$).

- **Line 1:** Set the data format to Degrees Celsius ($^{\circ}F$) with HLL terminator of **None**.
- **Line 2:** Configure four channels – 1, 2, 3, and 4 – with no setpoints.
- **Line 3:** Provide the appropriate command lines to configure and start an acquisition.
- **Line 4:** After an indiscriminate amount of time, query the Last channel readings.
- **Line 5:** Get the response.
- **Line 6:** The screen will show the Last readings for Channels 1 through 4.

Example 13e. Query Last Scan Reading (U13) with Volts & No HLL Terminator

```
(1) PRINT#1, "OUTPUT07;F0,0X Q1,0,0,0,0X"  
(2) PRINT#1, "OUTPUT07;C1-4,11X"  
(3) (Command lines to configure and start an acquisition.)  
(4) PRINT#1, "OUTPUT07;U13X"  
(5) PRINT#1, "ENTER07"  
(6) INPUT A$  
      +00.0045603 +00.0000895 -00.0080087 +00.0090865
```

The next example demonstrates how changing the channel type can effect the output of HLL queries. It also shows the effect of specifying no HLL terminator; only one **ENTER** command returns all of the HLL data. Notice that even though the data format was in Degrees Celsius ($^{\circ}\text{C}$), the response is in Volts since the channels were configured as such.

- **Line 1:** Set the data format to Degrees Celsius ($^{\circ}\text{C}$) with HLL terminator of **None**.
- **Line 2:** Configure four channels – 1, 2, 3, and 4 – to Volts (despite the Degrees Celsius) in the ± 100 mV DC range.
- **Line 3:** Provide the appropriate command lines to configure and start an acquisition.
- **Line 4:** After an indiscriminate amount of time, query the Last channel readings.
- **Line 5:** Get the response.
- **Line 6:** The screen will show the Last readings for Channels 1 through 4.

Example 13f. Read Last Readings (R#) with HLL Terminator

```
(1) PRINT#1, "OUTPUT07;F0,0 Q1,1,0,0,0X"  
(2) PRINT#1, "OUTPUT07;C1-4,1X"  
(3) (Command lines to configure and start an acquisition.)  
(4) PRINT#1, "OUTPUT07;R#2-3X"  
(5) PRINT#1, "ENTER07"  
(6) INPUT A$  
      +0250.60  
  
(7) PRINT#1, "ENTER07"  
(8) INPUT A$  
      -0049.50
```

The next example demonstrates how to retrieve Last readings for a subset of the configured channels. Notice that since a HLL response terminator was specified, the Last reading for each channel had to be entered separately.

- **Line 1:** Set the data format to Degrees Celsius ($^{\circ}\text{C}$) with HLL terminator of CR LF / EOI.
- **Line 2:** Configure four channels – 1, 2, 3, and 4 – with no setpoints.
- **Line 3:** Provide the appropriate command lines to configure and start an acquisition.
- **Line 4:** After an indiscriminate amount of time, query the Last readings for Channels 2 and 3.
- **Line 5:** Get the response.
- **Line 6:** The screen will show the Last reading for Channel 2.
- **Line 7:** Get the next response.
- **Line 8:** The screen will show the Last reading for Channel 3.

Comparing Buffered Data to HLL Data

With the TempScan/1100 unit, unless scans are being collected at the maximum possible frequency, the HLL Registers may detect alarm states that will not appear in the collected data. Since the HLL Registers are being updated at the maximum possible frequency, which may be considerably faster than the scan frequency as set by the programmed scan interval, an alarm state may be detected even though no such value can be found in the buffered scan data. If such a situation is not preferred, decreasing the programmed scan interval (thus increasing the scan frequency) will decrease the possibility of such an event. At the maximum possible scan frequency, this situation is guaranteed not to occur.

With the MultiScan/1200 unit, the HLL Registers are being updated at the same frequency as set by the programmed scan interval. Hence, all detected alarm states will appear in the collected data.

Status-Reporting & Mask Registers

The TempScan/1100 or MultiScan/1200 has several internal 8-bit registers dedicated to status and event reporting, where each bit represents a certain condition, event or error. You can access these registers via commands issued from the PC/IEEE 488 controller.

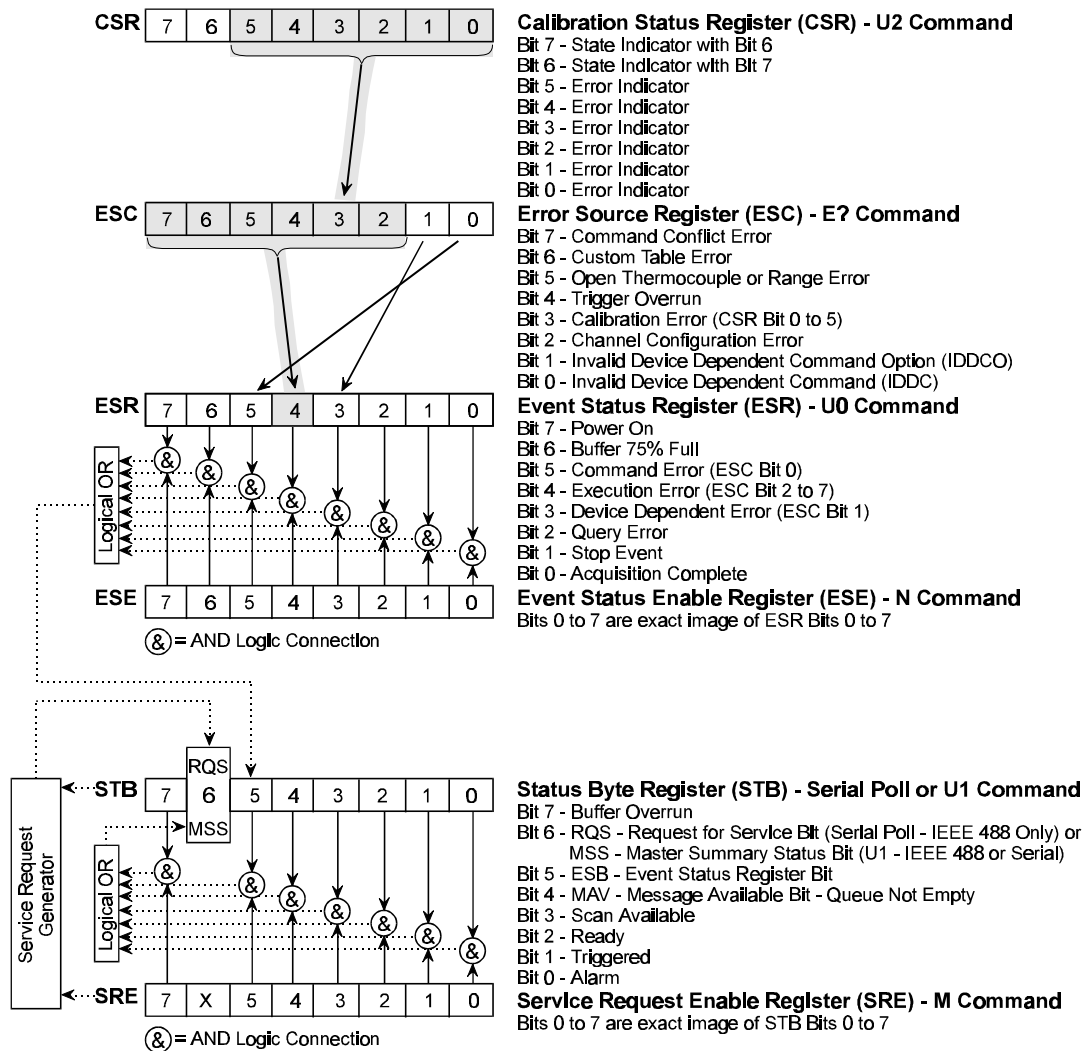

Status-Reporting & Mask Registers

Theory of Operation

Each register is part of a hierarchy of status-reporting and mask registers where operations on higher registers will affect the contents of lower registers in the chain. This hierarchical approach provides various levels of status reporting. The lowest levels give general event status information while the higher levels give more details of the particular events. In the same way that the setting of events or conditions affects the lower-level registers in the chain, the clearing of events or conditions in the higher-level registers also clears those affected conditions in the lower-level registers.

Status-Reporting Registers

The following four registers cover a wide range of internal error and event conditions. Each of these registers covers a particular aspect of event reporting responsibility. These registers are briefly defined as follows:

- **Calibration Status Register (CSR):** Read/Clear-Only, via the following *User Status* (**U**) command – Query and clear the Calibration Status Register (**U2**). Indicates any error conditions during TempScan/1100 or MultiScan/1200 calibration.
- **Error Source Register (ESC):** Read/Clear-Only, via the *Query Error Status* (**E?**) command. Indicates any general error conditions with the TempScan/1100 or MultiScan/1200 unit.
- **Event Status Register (ESR):** Read/Clear-Only, via the following *User Status* (**U**) command – Query and clear the Event Status Register (**U0**). Indicates special events that have occurred in the TempScan/1100 or MultiScan/1200 unit.
- **Status Byte Register (STB):** Read-Only, via the Serial Poll (**SPOLL**) command (IEEE 488 only) or the following *User Status* (**U**) command – Query the Status Byte Register (**U1**) (IEEE 488 or serial). Indicates critical operation events with the TempScan/1100 or MultiScan/1200 unit.

Mask Registers

In addition, the following two mask registers are used to configure the status and event reporting registers. These mask registers are briefly defined as follows:

- **Event Status Enable Register (ESE):** Read/Write/Clear, via the following *Set Event Mask* (**N**) commands – **N?**, **Nmask**, and **N0**, respectively. A mask for the Event Status Register (**ESR**).
- **Service Request Enable Register (SRE):** Read/Write/Clear, via the following *Set SRQ Mask* (**M**) commands – **M?**, **Mmask**, and **M0**, respectively. A mask for the Status Byte Register (**STB**).

Status-Reporting Registers

Calibration Status Register (CSR)

The Calibration Status Register (**CSR**) is a Read/Clear-Only register in that it may only be read and cleared by the controller, via the following *User Status (U)* command – Query and clear the Calibration Status Register (**U2**). The read operation is a destructive read since it clears the register as it is read. This register can only be written to by internal TempScan/1100 or MultiScan/1200 operations.

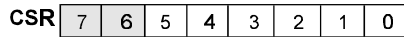

Calibration Status Register (CSR) - U2 Command

Bits 7/6 - State Indicators where:

- 00 - Normal Run Mode
- 01 - EPROM Test Mode (Not discussed in this manual.)
- 10 - Calibration Mode, Idle
- 11 - Calibration Mode, Command Active

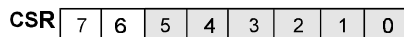

Calibration Status Register (CSR) - U2 Command

Bits 5/4/3/2/1/0 - Error Indicators where:

Bit	Normal Run Mode	Calibration Modes
Bit 5	Read Failure	Read Failure - EEPROM Error
Bit 4	Write Failure	Write Failure - EEPROM Error
Bit 3	Checksum Error	Checksum Error - EEPROM Error
Bit 2	NV-RAM Error	Calibration Error - See Below
Bit 1	Invalid Password	Invalid Password
Bit 0	Invalid Command	Invalid Command

Bit 2 Calibration Mode Errors

- If calibrating thermocouple offset, then offset is out of the range:
-365 counts (-50 mV) < offset < +365 counts (+50 mV)
- If calibrating high-voltage offset, then offset is out of the range:
-583 counts (-80 mV) < offset < +583 counts (+80 mV)
- If calibrating thermocouple gain, then gain is out of the range:
+0.8 (ratio) < gain < +1.2 (ratio)
- If calibrating CJC temp. sensor offset, then offset is out of the range:
-1000 counts (-10 deg C) < offset < +1000 counts (+10 deg C)

Calibration Status Register (CSR)

The Calibration Status Register (**CSR**) indicates calibration errors, if any, have occurred. Its bits and the errors that set them, are as follows:

- **State Indicators (Bits 7 and 6):** The Bits 7/6 are set as follows:
 - 00 – *Normal Run Mode*, set when the TempScan/1100 or MultiScan/1200 unit is in the state of normal operation.
 - 01 – *EEPROM Test Mode*, set when testing a scanning card EEPROM (Electronically Erasable, Programmable Read-Only Memory). This internal mode will not be discussed in this manual.
 - 10 – *Calibration Mode (Idle)*, set when the TempScan/1100 or MultiScan/1200 unit is in idle *Calibration Mode*.
 - 11 – *Calibration Mode (Command Active)*, set when the TempScan/1100 or MultiScan/1200 unit is in active *Calibration Mode*.
- **Error Indicators (Bits 0 to 5) in Normal Run Mode (00):** Any calibration error in any of the four modes will be mapped into the **CSR** Bits 0 to 5, which together maps to the Calibration Error Bit (Bit 3) in the Error Source Register (**ESC**). In this normal mode, these six bits are set as follows:
 - Bit 5:** *Read Failure.*
 - Bit 4:** *Write Failure.*
 - Bit 3:** *Checksum Error.*
 - Bit 2:** *NV-RAM Error.*
 - Bit 1:** *Invalid Password.*
 - Bit 0:** *Invalid Command.*

- **Error Indicators (Bits 0 to 5) in Calibration Modes (10 or 11):** Any calibration error in any of the four modes will be mapped into the **CSR** Bits 0 to 5, which together maps to the Calibration Error Bit (Bit 3) in the Error Source Register (**ESC**). In either *Calibration Mode*, these same six bits are set as follows:

Bit 5: *Read Failure (EEPROM Error).*

Bit 4: *Write Failure (EEPROM Error).*

Bit 3: *Checksum Error (EEPROM Error).*

Bit 2: *Calibration Error.* Set when the thermocouple offset or gain, or CJC (cold-junction compensation) temperature sensor offset is outside of the valid range values, as follows:
 -365 ASCII Counts (-50 mV) ≤ thermocouple offset ≤ +365 ASCII Counts (+50 mV)
 -583 ASCII Counts (-80 mV) ≤ high-voltage offset ≤ +583 ASCII Counts (+80 mV)
 +0.8 (ratio) ≤ thermocouple gain ≤ +1.2 (ratio)
 -1000 ASCII Counts (-10°C) ≤ CJC sensor offset ≤ +1000 ASCII Counts (+10°C)

Bit 1: *Invalid Password.*

Bit 0: *Invalid Command.*

A checksum is used for validating the contents of memory. When the contents of memory is created, each byte is summed and the least significant byte of the resultant sum is stored in a specific byte of memory. This value is called the checksum. Then typically on power-up, the processor recomputes the checksum and compares it to its stored known correct value. If the computed and stored checksums match, then the memory is fine. Otherwise, if they do not match, then the memory became corrupt somehow. For example, on power-up and during calibration, the TempScan/1100 unit computes the checksum on the chassis calibration constants in NV-RAM, and on the EEPROMs of each installed scanning card. If any of the checksum tests fail, the Checksum Bit (Bit 3) is set in the Calibration Status Register (**CSR**).

For more information on NV-RAM and EEPROMs, see section *Calibration Properties* in the chapter *System Calibration*. For more information on the Calibration Status Register (**CSR**), see command *User Status* (**U**).

Error Source Register (ESC)

The Error Source Register (**ESC**) is a Read/Clear-Only register in that they may only be read and cleared by the controller, via the *Query Error Status* (E?) command. The read operation is a destructive read since it clears the register as it is read. This register can only be written to by internal TempScan/1100 or MultiScan/1200 operations.

The Error Source Register (**ESC**) indicates which general errors, if any, have occurred. Its bits and the errors that set them, are as follows:

- **Command Conflict Error (Bit 7):** Set when an issued command is in conflict with other issued commands or with the current configuration. This error usually occurs when an issued command cannot be performed because it is incompatible with the current state of the TempScan/1100 or MultiScan/1200 unit. This bit is one of the **ESC** Bits 2 to 7, which together maps to the Execution Error Bit (Bit 4) in the Event Status Register (**ESR**).
- **Open Thermocouple or Range Error (Bit 5):** Set when the hardware circuitry detects an open thermocouple, or the software routines detect either that the input A/D data has reached its maximum value or the input data has exceeded its linearization limits. This bit is one of the **ESC** Bits 2 to 7, which together maps to the Execution Error Bit (Bit 4) in the **ESR**.
- **Trigger Overrun (Bit 4):** Set when more than one *Trigger* (trigger start event) or more than one *Stop* (trigger stop event) occurs during one *Trigger Block* acquisition, or when when an unexpected *Trigger* occurs. This bit is one of the **ESC** Bits 2 to 7, which together maps to the Execution Error Bit (Bit 4) in the **ESR**.
- **Calibration Error (Bit 3):** Set when the calibration is inappropriate or has failed. The Error Indicator Bits (Bits 0 to 5) in the Calibration Status Register (**CSR**) together map to this bit. This bit is one of the **ESC** Bits 2 to 7, which together maps to the Execution Error Bit (Bit 4) in the **ESR**.

- **Channel Configuration Error (Bit 2):** Set when a channel has been inappropriately configured, either because the channel is not present or because the specified channel type is incompatible with the scanning card type installed. This bit is one of the **ESC** Bits 2 to 7, which together maps to the Execution Error Bit (Bit 4) in the **ESR**.
- **Invalid Device Dependent Command Option (IDDCO) (Bit 1):** Set when a command parameter is out of range or missing. This bit in turn maps to the Device Dependent Error Bit (Bit 3) in the **ESR**.
- **Invalid Device Dependent Command (IDDC) (Bit 0):** Set when there is a command syntax error. This bit in turn maps to the Command Error Bit (Bit 5) in the **ESR**.

For more information, see command *Query Error Status (E?)* in the chapter *API Command Reference*.

Event Status Register (ESR)

The Event Status Register (**ESR**) is a Read/Clear-Only register in that it may only be read and cleared by the controller, via the following *User Status (U)* command – Query and clear the Event Status Register (**U0**). . The read operation is a destructive read since it clears the register as it is read. This register can only be written to by internal TempScan/1100 or MultiScan/1200 operations.

The Event Status Register (**ESR**) indicates which special events, if any, have occurred. Its bits and the events that set them, are as follows:

- **Power On (Bit 7):** Set when the TempScan/1100 or MultiScan/1200 unit is first powered up or when the *Reset Power-On (*R)* command is issued.
- **Buffer 75% Full (Bit 6):** Set when the Acquisition Buffer has been filled to at least 75% of its capacity. This bit is cleared when the amount of data in the Acquisition Buffer falls below 75% of its capacity.
- **Command Error (Bit 5):** Set when an illegal command or command syntax error is detected. The Invalid Device Dependent Command (IDDC) Bit (Bit 0) in the Error Source Register (**ESC**) maps to this bit.
- **Execution Error (Bit 4):** Set when one of several errors has occurred during the execution of a command. Bits 2 through 7 in the Error Source Register (**ESC**) together map to this bit.
- **Device Dependent Error (Bit 3):** Set when a conflict error has occurred. A conflict error is generated when a command cannot execute correctly because it would interfere with other commands or settings. The Invalid Device Dependent Command Option (IDDCO) Bit (Bit 1) in the Error Source Register (**ESC**) maps to this bit.
- **Query Error (Bit 2):** Set when the controller has attempted to read from the TempScan/1100 or MultiScan/1200 output queue when no response is present or pending, or when a response has been lost. Data may be lost when too much data is requested to be buffered in the queue, where the controller has sent a new query before reading the response to a prior query.
- **Stop Event (Bit 1):** Set when the user-defined *Stop* (trigger stop event) of a configured acquisition has been satisfied. This bit is cleared when a new acquisition is configured either through the *Set Trigger Configuration (T)* command or when the unit is re-armed via the *Auto Re-arm* mode.
- **Acquisition Complete (Bit 0):** Set when the acquisition operation has been completed. An acquisition is complete when the TempScan/1100 or MultiScan/1200 unit has finished the current acquisition. The bit will be cleared when a new acquisition is configured through the *Set Trigger Configuration (T)* command.

For more information, see command *User Status (U)* in the chapter *API Command Reference*.

Status Byte Register (STB)

The Status Byte Register (**STB**) is a Read-Only register in that it can only be read by the controller, via the Serial Poll (**SPOLL**) command (IEEE 488 only) or the following *User Status* (**U**) command – Query the Status Byte Register (**U1**) (IEEE 488 or serial). This register can only be cleared or written to by the internal processes of the TempScan/1100 or MultiScan/1200.

The Status Byte Register (**STB**) is at the lowest-level status-reporting register in the register hierarchy. When the controller accesses this register in real-time via an IEEE 488 **SPOLL** command, this access allows the quick response of certain critical operational status conditions contained in the **STB**. Since this is the lowest-level register, every other status register in the system, either directly or indirectly, has access to the **STB** via the Event Status Register Bit (**ESR** Bit 5, or **ESB**) in the **STB**. Such access gives these other status registers the ability to quickly report their general status to the controller.

The TempScan/1100 or MultiScan/1200 sets the Message Available Bit (**MAV**, Bit 4) in the Status Byte Register (**STB**) to determine if data can be read by the controller. This is the only status register which may require the RS-232/RS-422 serial interface to implement a different read command – Query the Status Byte Register (**U1**) – than the IEEE 488 interface which primarily implements the Serial Poll (**SPOLL**) command (but can also use the **U1** command).

The Status Byte Register (**STB**) indicates which critical operation events, if any, have occurred. Its bits and the events that set them, are as follows:

- **Buffer Overrun (Bit 7):** Set if an overrun of the Acquisition Buffer occurs. It is cleared when the buffer becomes empty by either reading out the contents of the buffer or performing the *Flush Acquisition Buffer* (***B**) command.
- **Request for Service Bit (RQS) or Master Summary Status Bit (MSS) (Bit 6):** Set when the TempScan/1100 or MultiScan/1200 unit is requesting service. It is cleared when the following is performed: Serial Poll (**SPOLL**) command (IEEE 488 only) or the following *User Status* (**U**) command – Query the Status Byte Register (**U1**) (IEEE 488 or RS-232/RS-422 serial).
- **Event Status Register Bit (ESB) (Bit 5):** Reflects the logical *OR* of all the bits in the Event Status Register (**ESR**) *AND*ed with their equivalent enable bits in the Event Status Enable Register (**ESE**). This bit is set if at least one bit in the **ESR** is set and its corresponding bit in the **ESE** is also set.
- **Message Available (MAV) (Bit 4):** Set when there is data available in the output queue to be read. It is cleared when the output queue is empty. This bit reflects whether any command responses are still in the output queue.
- **Scan Available (Bit 3):** Set when at least one acquisition scan is available in the Acquisition Buffer to be read. This bit is cleared when there are no scans available in the buffer to be read.
- **Ready (Bit 2):** Set when the TempScan/1100 or MultiScan/1200 unit has completed executing a set of commands and is ready to process another command from the IEEE 488 bus controller. It is cleared when the unit is processing a command line. This bit should be examined with a Serial Poll (**SPOLL**) prior to issuing a new command line. This allows any detected errors to be traced to the specific command line containing the error. If all of the setup information for a specific operation is included in one line, this bit also indicates when all processing is done and the *Execute* (**X**) command is completed. This ensures that the unit is finished processing all of its internal state changes before initiating any further activity.
- **Triggered (Bit 1):** Set when the TempScan/1100 or MultiScan/1200 unit has detected a valid *Trigger* (trigger start event) or *Stop* (trigger stop event) condition from the programmed trigger source. This bit is cleared when the acquisition is complete or the *Trigger* or *Stop* is reconfigured.
- **Alarm (Bit 0):** Set when the TempScan/1100 or MultiScan/1200 unit has detected a valid alarm condition. This bit is cleared whenever the alarm condition no longer exists.

For more information, see command *User Status* (**U**) in the chapter *API Command Reference*.

Mask Registers

Event Status Enable Register (ESE)

The Event Status Enable Register (**ESE**) is a Read/Write/Clear register in that they can be written and cleared, as well as read by the controller, via the following *Set Event Mask (N)* commands – **N?**, **Nmask**, and **N0**, respectively.

The Event Status Enable Register (**ESE**) may be used to define which bits in the Event Status Register (**ESR**) will be mapped into the **ESR** Bit 5 (or **ESB**) in the Status Byte Register (**STB**). The bits in the **ESE** represent an exact image of the bits in the **ESR**. When a condition is set in the **ESR**, its image bit is checked in the **ESE**. If any image bits are enabled, the bits in the **ESR** will be mapped into the **ESR** Bit 5 (or **ESB**) in the **STB**.

The Event Status Enable Register (**ESE**) controls which events, if any, are to be reflected in the Status Byte Register (**STB**). The bits of the Event Status Register (**ESR**) are logically *ANDed* with the corresponding bits of the **ESE**, and the resulting bits are logically *ORed* together in the Status Byte Register (**STB**). The **ESE** does not affect the **ESR**; it only affects the **ESR** Bit 5 (or **ESB**) of the **STB**. The **ESR** Bit 5 (or **ESB**) in the **STB** is set when its corresponding Bit 5 in the Service Request Enable Register (**SRE**) is enabled. The **ESE** is set and interrogated with the *Set Event Mask (N)* command. For more information, see command *Set Event Mask (N)* in the chapter *API Command Reference*.

Service Request Enable Register (SRE)

The Service Request Enable Register (**SRE**) is a Read/Write/Clear register in that it can be written and cleared, as well as read by the controller, via the *Set SRQ Mask (M)* commands – **M?**, **Mmask**, and **M0**, respectively.

The Service Request Enable Register (**SRE**) may be used to define those conditions in the Status Byte Register (**STB**) which will generate a Service Request (**SRQ**). The bits in the **SRE** represent an exact image of the bits in the **STB** except for the Request for Service Bit (**RQS**, Bit 6) or Master Summary Status Bit (**MSS**, Bit 6). When a condition is set in the **STB**, its image bit is checked in the **SRE**. If the image bit is enabled, the TempScan/1100 or MultiScan/1200 will generate a Service Request (**SRQ**).

The Service Request Enable Register (**SRE**) controls which bits of the Status Byte Register (**STB**) are reflected in the Request for Service Bit (**RQS**, Bit 6) and Master Summary Status Bit (**MSS**, Bit 6) of the **STB**. The bits of the **STB** are logically *ANDed* with the corresponding bits of the **SRE**. The resulting bits are logically *ORed* together to form the Master Summary Status Bit (**MSS**, Bit 6) in the **STB** and to control the Request for Service Bit (**RQS**, Bit 6) in the **STB**. The **SRE** does not affect the **STB**; it only affects the **MSS** and **RQS** Bits of the **STB**. The **ESE** is set and interrogated with the *Set SRQ Mask (M)* command. For more information, see command *Set SRQ Mask (M)* in the chapter *API Command Reference*.

Using Status-Reporting Registers

As previously mentioned, the status-reporting registers are organized in a hierarchical structure. The lower-level registers contain more-general event information, and the higher-level registers contain more-detailed information about particular events. Typically, the lowest-level status-reporting register, the Status Byte Register (**STB**) contains time-critical information that may require more immediate action from the controller. In addition, other registers may access the **STB** via the **ESR** Bit (or **ESB**). This allows any condition within the status-reporting register hierarchy to have access to the **STB**, Serial Poll (**SPOLL**), and Service Request (**SRQ**).

Example 13g. Status-Reporting Register Hierarchy

```
(1) PRINT#1, "OUTPUT07;N0 X N8 X"
(2) PRINT#1, "OUTPUT07;M0 X M32 X"

(3) PRINT#1, "OUTPUT07;E?X"
(4) PRINT#1, "ENTER07"
(5) INPUT A$
    E008

(6) PRINT#1, "OUTPUT07;U2X"
(7) PRINT#1, "ENTER07"
(8) INPUT A$
    E002

(9) PRINT#1, "OUTPUT07;U0X"
(10) PRINT#1, "ENTER07"
(11) INPUT A$
    E000

(12) PRINT#1, "SPOLL07"
    4
```

The above example demonstrates how the status reporting register hierarchy works. Notice that clearing of the higher-level registers clears the bits in the lower-level registers that were associated with the root cause of the condition.

- **Line 1:** Configure the **ESR** Bit 5 (or **ESB**) in the **STB** to be set when a Device Dependent Error occurs.
- **Line 2:** Configure the Service Request (**SRQ**) when the **ESB** in the **STB** occurs.

Now the TempScan/1100 or MultiScan/1200 unit is configured so that when any Device Dependent Error occurs, the unit will issue a Service Request (**SRQ**) to the controller. When the **SRQ** occurs, the controller may perform the following sequence to determine the exact cause of the Service Request.

- **Line 3:** Query the **ESC** to determine the cause of the error.
- **Line 4:** Get the response.
- **Line 5:** The screen will show a Calibration Error (Bit 3 value = $2^3 = 008$).
- **Line 6:** Now, query the **CSR** to determine the specific cause of the Calibration Error.
- **Line 7:** Get the response.
- **Line 8:** The screen will show a Calibration Invalid Password Error (Bit 1 value = $2^1 = 002$).
- **Line 9:** Now, query the **ESR**. (Reading the **ESC** should have cleared it.)
- **Line 10:** Get the response.
- **Line 11:** The screen will show that the Device Dependent Error is no longer there.
- **Line 12:** Serial Poll the **STB**. The screen will show that the **ESB** in the **STB** is no longer set. Only Ready Bit 2 is set. (Ready Bit 2 value = $2^2 = 004$).

Additional Operation

Trigger Latency

Each trigger source has an associated latency. This latency is the time between the actual *Trigger* (trigger start event) and its recognition by the TempScan/1100 or MultiScan/1200 unit.

The following latency times are simplistic representations of the time between when the *Trigger* is detected and when the *Trigger* has been processed. The hardware latency times, and the Interrupt Service Routine (ISR) times to process other tasks during the trigger event but before its detection, are not accounted for. In other words, these times may be offset as much as the hardware latency times, in addition to the process time taken by the longest uninterrupted ISR.

Trigger Source & Latency			
Type(s)	Trigger Source	Trigger Latency (Average)	Observed Variation
1	@ character	2.255 ms	620.00 μ s
2	GET (IEEE only)	645.6 μ s	3.10 μ s
3	TALK (IEEE only)	780.53 μ s	12.00 μ s
4, 5	Selected Temperature Channel (Level)	(See Note below)	(See Note below)
6, 7	External TTL (Rising or Falling)	610.95 μ s	2.10 μ s
8	Count (Post-Trigger)	45.9 μ s	28.5 μ s
9, 10	Alarm	(See Note below)	(See Note below)
11	Absolute Time	44.5 μ s	27.0 μ s

Note: (1) When using a channel level or alarm as the trigger source, the trigger latency is dependent on the number of channels. (2) With the TempScan/1100 unit, the maximum trigger latency is the minimum scan time interval (as dictated by the maximum possible frequency) allowable by the current configuration. (3) With the MultiScan/1200 unit, the maximum trigger latency is the greater of the following time values: The programmed scan time interval, or the minimum scan time interval (as dictated by the maximum possible frequency) allowable by the current configuration.

Real-Time Clock

The TempScan/1100 or MultiScan/1200 contains a battery-backed-up internal real-time clock which is programmable when set and read. Factory set according to Eastern Standard Time (U.S.), the real-time clock runs in military time. Although setting the real-time clock time via the *Set Real-Time Clock* (**s**) command, and setting the *Trigger* (trigger start event) and *Stop* (trigger stop event) times via the *Program Trigger Times* (**P**) command, are done at a resolution of only 0.1 second (tenths of a second), the real-time clock actually operates at a resolution of 0.001 second (milliseconds). This millisecond resolution is evident in the Time/Date stamping of channel data output which is retrieved from the High/Low/Last (HLL) Registers or the Acquisition Buffer.

For more information on setting the real-time clock, see command *Set Real-Time Clock* (**s**) in the chapter *API Command Reference*. For more information on Time/Date stamping and data formats, see section *Stamping Configuration* and section *Data Format Configuration* in the chapter *System Configuration*.

Open Thermocouple & Range Error Checking

The TempScan/1100 or MultiScan/1200 unit possesses built-in utilities for the detection of open thermocouple and range errors on configured channels, as follows:

- **One hardware utility:** The thermocouple cards contain circuitry to detect open thermocouples.
- **Two software utilities:** The software detection routines are designed to detect if the input A/D reaches its maximum value, and to detect if an input exceeds the linearization limits.

If an open thermocouple or a range error is detected, then Bit 5 in the Error Source Register (**ESC**) will be set. In turn, Bits 2 to 7 (including Bit 5) in the **ESC** will together be mapped into the Execution Error Bit (Bit 4) in the Event Status Register (**ESR**), denoting that this particular error condition exists. The offending channel(s) can be determined by reading their values. If a channel is in error, its value will be the following:

- If a Thermocouple channel (assuming degrees Celsius): ± 3276.70 .
- If a Volts channel for the TempScan/1100 unit: ± 32.7670 .
- If a Volts channel for the MultiScan/1200 unit: ± 005.767 .

Note: Open thermocouple and range error checking is only performed on configured channels.

Software Digital Filtering (TempScan/1100 Only)

As a standard feature, the TempScan/1100 employs an advanced software digital filter to ensure quiet and accurate thermocouple input. This feature is enabled as part of the factory default settings. With the *Set Software Digital Filtering (*w)* command, this digital filtering feature can be disabled in order to improve reaction response time, or re-enabled to reinstate the feature.

For information on MultiScan/1200 noise filtering, see section *Measuring Modes (MultiScan/1200 Only)* in the chapter *System Configuration*.

Introduction	225
Calibration Setup	225
Calibration Properties.....	225
Calibration Protection.....	226
Calibration Status.....	226
Calibration Password.....	227
Calibration of Master Chassis	228
Calibration of Scanning Cards	230
Calibration of Thermocouple Scanning Cards.....	232
Calibration of Voltage Scanning Cards.....	236
Calibration of RTD Scanning Cards.....	237

Introduction

Prior to shipment, each TempScan/1100, MultiScan/1200, Exp/10A, and Exp/11A unit, as well as each TempScan/1100 and MultiScan/1200 scanning card, is calibrated. Depending on your operating guidelines, your equipment will require periodic calibration to ensure accuracy at all times. The industry standard for this calibration is once every six months.

Calibration can be performed via the traditional manual method or via a software-automated method. Manual calibration is supported by operating in *Calibration Mode*, in which a specific set of commands is provided. Meanwhile, software-automated calibration is provided by using ScanCal, which is included with the installation of TempView.

Note: Using ScanCal is not essential. But if you have access to a PC with Windows 3.X or Windows 95, we strongly suggest using this application. See chapter *ScanCal*.

The following text discusses the *traditional manual method* of calibration. For more information on the software-automated method of calibration using ScanCal, see chapter *ScanCal*.

Calibration Setup

Calibration Properties

For proper results, the TempScan/1100 or MultiScan/1200 master chassis and each scanning card must be calibrated separately. The master chassis contains an on-board battery-backed-up NV-RAM (Non-Volatile Random-Access Memory) and each card contains an on-board EEPROM (Electrically Erasable Programmable Read-Only Memory) for saving calibration constants, allowing for card-swapping within a system, card-swapping between systems, as well as system expansion. Calibration relates to the master chassis and scanning cards as follows:

- **Master Chassis:** Calibrated for channel offset and channel gain only.
- **Option Cards:** Calibrated for channel offset, channel gain, and cold junction sensor offset (if thermocouples are used).

Calibration Protection

The chassis calibration constants and the calibration password are stored by the TempScan/1100 or MultiScan/1200 in Non-Volatile RAM (NV-RAM). The password is a safety feature used to prevent unauthorized personnel from entering *Calibration Mode* and altering the calibration constants.

As a safeguard, the calibration password and chassis calibration constants are hardware protected. This protection is enabled by setting the microswitch 9 to the down (0) position on the rear panel DIP switch. This is the default factory setting and should remain in this position unless purposely attempting to change the password or chassis constants.

If it is necessary to change the calibration password via the *Change Calibration Keyword* (*κ) command, or to recalibrate the chassis, this hardware write protection can be disabled by setting microswitch 9 to the up (1) position.

CAUTION



To ensure accurate measurements, calibration must only be performed by authorized personnel.

CAUTION



To ensure the integrity of the chassis calibration constants, verify that DIP microswitch 9 is set in the down (0) position unless you are attempting to change the calibration password or chassis calibration constants.

CAUTION



Do not perform calibration until after your TempScan/1100 or MultiScan/1200 system has been powered on for at least one hour.

CAUTION



Do not forget to set DIP microswitch 9 back to the down (0) position when calibration is complete. Otherwise, the calibration password and calibration chassis constants may be corrupted and normal operation may be disrupted.

Calibration Status

Once the TempScan/1100 or MultiScan/1200 hardware write protection is disabled, you can enter *Calibration Mode* via the *Enter Calibration Mode* (κ) command. When a valid password has been executed and *Calibration Mode* has been activated, Bit 7 in the Calibration Status Register (CSR) will be set. This bit is cleared by the *End Calibration Mode* (ε) command.

During *Calibration Mode*, the TempScan/1100 or MultiScan/1200 unit will be in one of two states: Idle or command active. Whenever a calibration command is active, Bit 6 in the Calibration Status Register (CSR) will be set and the TRIGGER LED indicator will flash for a few seconds. Once all of the indicators are off, the unit will return to an idle state, and Bit 6 in the CSR will be cleared and ready for the next calibration command. At this point, the next step in the procedure can be started. For more information on *Calibration Mode*, see commands *Enter Calibration Mode* (κ) and *End Calibration Mode* (ε) in the chapter *API Command Reference*. For more information on the Calibration Status Register (CSR), see chapter *System Operation*.

Calibration Password

Note: Attempts to execute calibration commands without entry into *Calibration Mode* will result in a calibration error, as follows: The Invalid Command Bit (Bit 0) in the Calibration Status Register (**CSR**) will be set, and in turn, any set Bits 0 to 5 in the **CSR** will be mapped into the Calibration Error Bit (Bit 3) in the Error Source Register (**ESC**).

To Change the Calibration Password

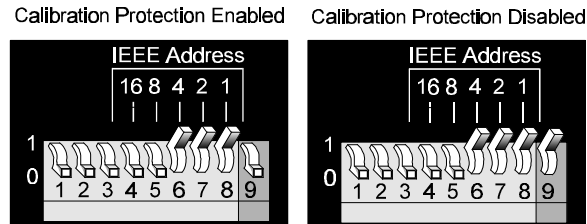

Calibration Protection Settings - Microswitch 9

1. Disable calibration protection by setting the rear panel DIP microswitch 9 to the up (*I*) position. Then enable *Calibration Mode* via the *Enter Calibration Mode* (**κ**) command with a valid password. The **keyword** is the five-digit keyword (or password) currently configured for the unit. Your scanning unit is shipped with a default password of **12345**. If the calibration password has not been changed, enter **κ12345**.
2. Once *Calibration Mode* has been entered, this password can be modified. Enter the *Change Calibration Keyword* (***κ**) command with a new five-digit password.
3. Wait for command to complete. The *TRIGGER* LED indicator will flash for a few seconds.
4. Monitor the Calibration Status Register (**CSR**) via the User Status (**υ**) command **υ2** to ensure that the command completed without error.
5. Disable *Calibration Mode* with the *End Calibration Mode* (**ε**) command. Re-enable calibration protection by resetting DIP microswitch 9 to the down (*0*) position.

For details on any of the above commands, see chapter *API Command Reference*.

Calibration of Master Chassis

- Note:** The following text discusses the *traditional manual method* of calibration. But if you have access to a PC with Windows 3.X or Windows 95, we strongly suggest using ScanCal. For information on the software-automated method of calibration using ScanCal, see chapter *ScanCal*.
- Note:** Prior to each calibration session, disable calibration protection by setting the rear panel DIP microswitch 9 to the up (*I*) position. Then enable *Calibration Mode* via the *Enter Calibration Mode* (**κ**) command with a valid password. If the default calibration password has not been changed, enter **κ12345**.
- Note:** At the end of each calibration session, disable *Calibration Mode* with the *End Calibration Mode* (**ε**) command. Then re-enable calibration protection by resetting DIP microswitch 9 to the down (*0*) position.

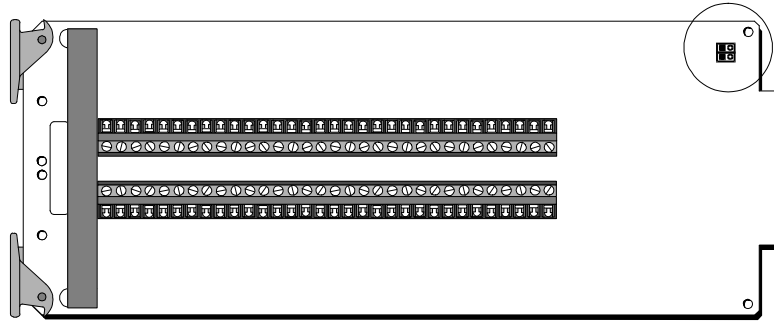

Location of Calibration Jumpers on Scanning Card

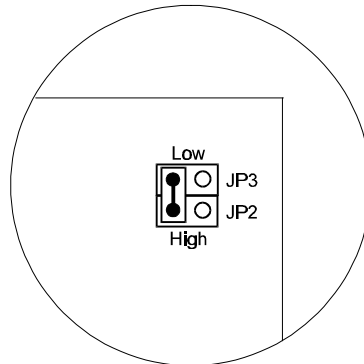

Shorting the Calibration Jumpers

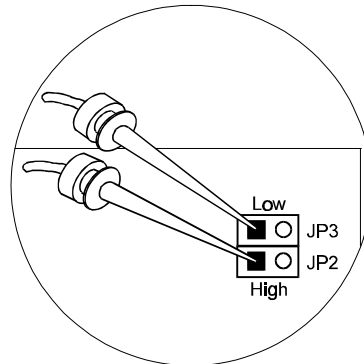

Connecting Clip Leads to the Calibration Jumpers

To Calibrate the Master Chassis for Offset

1. For offset calibration, locate the calibration jumpers located in one corner of an appropriate scanning card, remove the two calibration jumper caps and short the calibration jumpers using one of those jumper caps, as shown in the figure. Slide the scanning card into the master chassis.
2. Power up the unit and wait at least one hour before continuing.
3. Send the *Calibrate Channel Offset* (**H**) command **H0** – where channel **0** refers to the chassis – to the unit, and wait for the command to complete. The *TRIGGER* LED indicator will flash for a few seconds.
4. Monitor the Calibration Status Register (**CSR**) to ensure that the *Calibrate Channel Offset* (**H**) command completed without error. Refer to the *User Status* (**U**) command **U2** to monitor and decode the Calibration Status Register (**CSR**).
5. To monitor the chassis calibration voltage, configure a normal acquisition with Channel 3 set as channel type 90. The input will be returned in Counts.

To Calibrate the Master Chassis for Gain

CAUTION



Ensure that the master chassis has first been calibrated for offset. If not, follow the master chassis offset calibration procedure as described in the previous text.

1. For gain calibration, slide the scanning card out from the chassis, locate the calibration jumpers, remove any calibration jumper caps, and connect clip leads from the precision voltage calibration source, as shown in the figure. Use standard copper hookup wire. *Do not use thermocouple wire.* Slide the scanning card into the master chassis.
2. Power up the unit and wait at least one hour before continuing.
3. Set the precision voltage source to -4.4 (negative) Volts DC.
4. Send the *Calibrate Channel Gain* (**G**) command **G0,91** to the unit – where channel **0** refers to the chassis, and channel type **91** refers to a reserved calibration type – and wait for the command to complete. The *TRIGGER* LED indicator will flash for a few seconds.
5. Monitor the Calibration Status Register (**CSR**) to ensure that the *Calibrate Channel Gain* (**G**) command completed without error. Refer to the *User Status* (**U**) command **U2** to monitor and decode the Calibration Status Register (**CSR**).
6. To monitor the chassis calibration voltage, configure a normal acquisition with Channel 1 set as channel type 90. The input will be returned in Counts.
7. Next, set the precision voltage source to +4.4 (positive) Volts DC.
8. Repeat Steps 4, 5, and 6.

Calibration of Scanning Cards

Scanning Card Calibration Channels

The scanning cards described in the following text are applicable to specific scanning units, as shown in the first of the three table. For example, the TempV/32B voltage scanning card pertains to the TempScan/1100 unit only, whereas the MTC/24 thermocouple/volts scanning card pertains to the MultiScan/1200 unit only. For the convenience of TempScan/1000A users, the TempTC/32A, TempV/32A, and TempRTD/16A scanning cards have been included.

Scanning Card Calibration & Applicability				
Scanning Card Calibration		Master Unit Chassis		
		TempScan/1100	TempScan/1000A	MultiScan/1200
Thermocouple	Offset	TempTC/32B	TempTC/32A	MTC/24
	Gain	TempTC/32B	TempTC/32A	MTC/24
	CJC Offset	TempTC/32B	TempTC/32A	MTC/24
Voltage	Offset	TempV/32B	TempV/32A	MTC/24, MHV/24
	Gain	TempV/32B	TempV/32A	MTC/24
RTD	Offset	TempRTD/16B	TempRTD/16A	(N/A)
	Gain	TempRTD/16B	TempRTD/16A	(N/A)

Offset & Gain Channel Numbers						
Exp/10A		Exp/11A		Master Unit Chassis		
Unit #	Slot #	Unit #	Slot #	TempScan/1100 (of 992 Channels)	TempScan/1000A (of 992 Channels)	MultiScan/1200 (of 744 Channels)
1	1	1	1	33	33	25
	2		2	65	65	49
2	1		3	97	97	73
	2		4	129	129	97
3	1		5	161	161	121
	2		6	193	193	145
4	1		7	225	225	169
	2		8	257	257	193
5	1		9	289	289	217
	2		10	321	321	241
6	1	2	1	353	353	265
	2		2	385	385	289
7	1		3	417	417	313
	2		4	449	449	337
8	1		5	481	481	361
	2		6	513	513	385
9	1		7	545	545	409
	2		8	577	577	433
10	1		9	609	609	457
	2		10	641	641	481
11	1	3	1	673	673	505
	2		2	705	705	529
12	1		3	737	737	553
	2		4	769	769	577
13	1		5	801	801	601
	2		6	833	833	625
14	1		7	865	865	649
	2		8	897	897	673
15	1		9	929	929	697
	2		10	961	961	721
Master Unit Chassis Slot				1	1	1

The *Calibrate Channel Offset* (**H**) command – formatted as **Hchan** – and the *Calibrate Channel Gain* (**G**) command – formatted as **Gchan, type** – typically refer to calibration being performed on the first channel number **chan** of each selected scanning card. These typical channel values are indicated in the second table. However, any channel may be used. Make sure that the channel selected with the calibration command matches the channel connected to the precision voltage source. Note that all three of the TempScan/1100, TempScan/1000A, and MultiScan/1200 master chassis slots each uses scanning card Channel 1.

The *Calibrate Cold Junction Offset* (**J**) command – formatted as **Jchan, type, temp** – refers to calibration being performed on multiple channel numbers of each selected scanning card. The TempTC/32B (for the TempScan/1100) and TempTC/32A (for the TempScan/1000A) thermocouple scanning cards each have 4 on-card temperature-sensor channels for cold-junction compensation of the thermocouple signals, while the MTC/24 (for the MultiScan/1200) thermocouple/volts scanning card has only 3 on-card temperature-sensor channels.

The multiple temperature-sensing channels on each scanning card must be supplied with an accurate thermocouple signal of known warm-junction temperature. This may be accomplished by means of an accurate thermocouple calibration source or of an accurate measurement of the temperature of the existing thermocouple heat sources. Subsequently, the **J** command must be entered 4 times for each TempScan/1100 or TempScan/1000A scanning card, while the **J** command must be entered only 3 times for each MultiScan/1200 scanning card.

Cold-Junction Channel Numbers						
Exp/10A		Exp/11A		Master Unit Chassis		
Unit #	Slot #	Unit #	Slot #	TempScan/1100 (of 992 Channels)	TempScan/1000A (of 992 Channels)	MultiScan/1200 (of 744 Channels)
1	1	1	1	44,48,60,64	33,37,49,53	25,33,41
	2		2	76,80,92,96	65,69,81,85	49,57,65
2	1		3	108,112,124,128	97,101,113,117	73,81,89
	2		4	140,144,156,160	129,133,145,149	97,105,113
3	1		5	172,176,188,192	161,165,177,181	121,129,137
	2		6	204,208,220,224	193,197,209,213	145,153,161
4	1		7	236,240,252,256	225,229,241,245	169,177,185
	2		8	268,272,284,288	257,261,273,277	193,201,209
5	1		9	300,304,316,320	289,293,305,309	217,225,233
	2		10	332,336,348,352	321,325,337,341	241,249,257
6	1	2	1	364,368,380,384	353,357,369,373	265,273,281
	2		2	396,400,412,416	385,389,401,405	289,297,305
7	1		3	428,432,444,448	417,421,433,437	313,321,329
	2		4	460,464,476,480	449,453,465,469	337,345,353
8	1		5	492,496,508,512	481,485,497,501	361,369,377
	2		6	524,528,540,544	513,517,529,533	385,393,401
9	1		7	556,560,572,576	545,549,561,565	409,417,425
	2		8	588,592,604,608	577,581,593,597	433,441,449
10	1		9	620,624,636,640	609,613,625,629	457,465,473
	2		10	652,656,668,672	641,645,657,661	481,489,497
11	1	3	1	684,688,700,704	673,677,689,693	505,513,521
	2		2	716,720,732,736	705,709,721,725	529,537,545
12	1		3	748,752,764,768	737,741,753,757	553,561,569
	2		4	780,784,796,800	769,773,785,789	577,585,593
13	1		5	812,816,828,832	801,805,817,821	601,609,617
	2		6	844,848,860,864	833,837,849,853	625,633,641
14	1		7	876,880,892,896	865,869,881,885	649,657,665
	2		8	908,912,924,928	897,901,913,917	673,681,689
15	1		9	940,944,956,960	929,933,945,949	697,705,713
	2		10	972,976,988,992	961,965,977,981	721,729,737
Master Unit Chassis Slot				12,16,28,32	1,5,17,21	1,9,17

These multiple channel values are indicated in the third table. Make sure that the channels selected with the calibration command matches the channels connected to the precision thermocouple-calibration source.

Note: The following text discusses the *traditional manual method* of calibration. But if you have access to a PC with Windows 3.X or Windows 95, we strongly suggest using ScanCal. For information on the software-automated method of calibration using ScanCal, see chapter *ScanCal*.

CAUTION



Scanning card calibration requires the use of a calibrated master unit chassis.

Calibration of Thermocouple Scanning Cards

Note: Prior to each calibration session, disable calibration protection by setting the rear panel DIP microswitch 9 to the up (*I*) position. Then enable *Calibration Mode* via the *Enter Calibration Mode* (**κ**) command with a valid password. If the default calibration password has not been changed, enter **κ12345**.

Note: At the end of each calibration session, disable *Calibration Mode* with the *End Calibration Mode* (**ε**) command. Then re-enable calibration protection by resetting DIP microswitch 9 to the down (*0*) position.

To Calibrate a Thermocouple Card for Offset

1. Connect a Copper Short to Channel 1 on the scanning card being calibrated. Use standard copper hookup wire. *Do not use thermocouple wire.* Slide the scanning card into the previously-calibrated master chassis.
2. Power up the unit and wait at least one hour before continuing.
3. Send the *Calibrate Channel Offset* (**H**) command **Hchan** – where **chan** refers to the first channel number on the scanning card being calibrated (refer to the previous table for valid offset channel numbers) – and wait for the command to complete. The *TRIGGER* LED indicator will flash for a few seconds.
4. Monitor the Calibration Status Register (**CSR**) to ensure that the *Calibrate Channel Offset* (**H**) command completed without error. Refer to the *User Status* (**U**) command **U2** to monitor and decode the Calibration Status Register (**CSR**).

To Calibrate a Thermocouple Card for Gain

CAUTION



Ensure that the thermocouple scanning card has been calibrated for offset. If not, follow the thermocouple card offset calibration procedure as described in the previous text.

1. Connect a precision voltage source to Channel 1 on the scanning card being calibrated. Use standard copper hookup wire. *Do not use thermocouple wire.* Slide the scanning card into the previously-calibrated master chassis.
2. Power up the unit and wait at least one hour before continuing.
3. Set the *Part A* precision voltage source and send its corresponding *Calibrate Channel Gain (G)* command **Gchan, type** – where **chan** refers to the first channel number on the scanning card being calibrated (refer to the previous table for valid gain channel numbers) – from the following list:

• <i>Part A:</i>	-13.82 mV	Gchan, 7	• <i>Part I:</i>	-47.70 mV	Gchan, 8
• <i>Part B:</i>	+13.82 mV	Gchan, 7	• <i>Part J:</i>	+47.70 mV	Gchan, 8
• <i>Part C:</i>	-18.70 mV	Gchan, 6	• <i>Part K:</i>	-54.90 mV	Gchan, 2
• <i>Part D:</i>	+18.70 mV	Gchan, 6	• <i>Part L:</i>	+54.90 mV	Gchan, 2
• <i>Part E:</i>	-21.12 mV	Gchan, 3	• <i>Part M:</i>	-77.00 mV	Gchan, 4
• <i>Part F:</i>	+21.12 mV	Gchan, 3	• <i>Part N:</i>	+77.00 mV	Gchan, 4
• <i>Part G:</i>	-43.00 mV	Gchan, 1	• <i>Part O:</i>	-100.00 mV	Gchan, 10
• <i>Part H:</i>	+43.00 mV	Gchan, 1	• <i>Part P:</i>	+100.00 mV	Gchan, 10

Wait for the *Part A* command to complete. The *TRIGGER* LED indicator will flash for a few seconds.

4. Monitor the Calibration Status Register (**CSR**) to ensure that the *Calibrate Channel Gain (G)* command completed without error. Refer to the *User Status (U)* command **U2** to monitor and decode the Calibration Status Register (**CSR**).
5. Repeat Steps 3 and 4 for each of the next fifteen parts: *Part B* through *Part P*.

To Calibrate a Thermocouple Card for Cold-Junction Offset

CAUTION



Ensure that the thermocouple scanning card has been calibrated for offset and gain. If not, follow the thermocouple card offset and gain calibration procedures as described in the previous text.

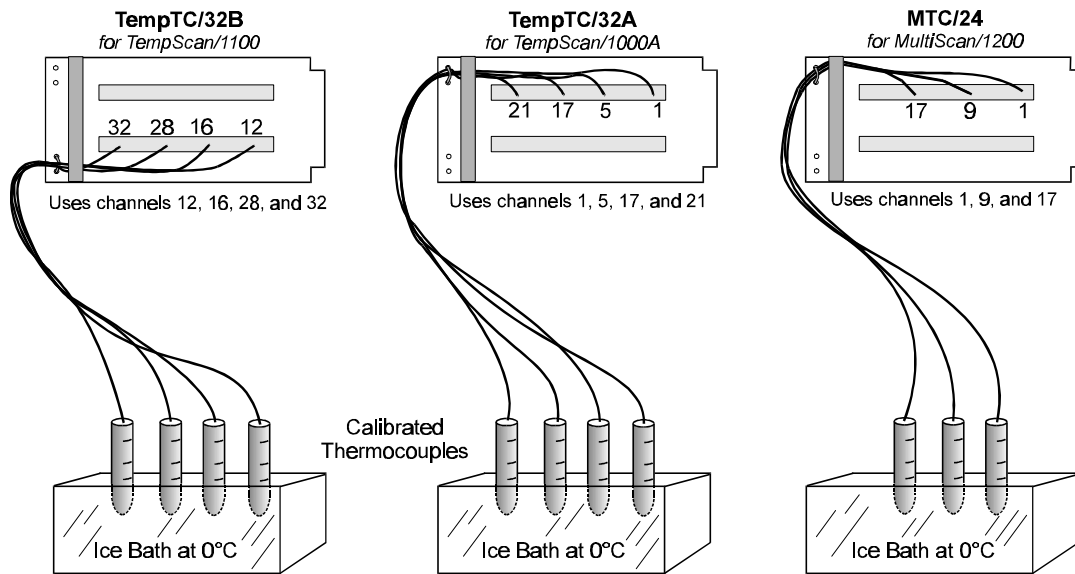

Cold-Junction Offset Calibration

- Connect accurate thermocouple sources to the following multiple channels on the scanning card being calibrated, where **chan** refers to the first channel number on the scanning card being calibrated (refer to the previous table for valid cold-junction channel numbers).
 - TempTC/32B (for TempScan/1100): **chan, chan+4, chan+16, chan+20**
 - TempTC/32A (for TempScan/1000A): **chan, chan+4, chan+16, chan+20**
 - MTC/24 (for MultiScan/1200): **chan, chan+8, chan+16**

Slide the scanning card into the previously-calibrated master chassis.
- Power up the unit and wait at least one hour before continuing.
- Apply the following temperature values in Celsius to the multiple cold-junction channels above:
 - TempTC/32B (for TempScan/1100): **nnn.n, ppp.p, qqq.q, rrr.r**
 - TempTC/32A (for TempScan/1000A): **nnn.n, ppp.p, qqq.q, rrr.r**
 - MTC/24 (for MultiScan/1200): **nnn.n, ppp.p, qqq.q**

4. Send the following *Calibrate Cold Junction Offset* (**J**) command **Jchan, type, temp** for the first cold-junction channel (temperature sensor #1):

- TempTC/32B (for TempScan/1100): **Jchan, type, nnn.n**
- TempTC/32A (for TempScan/1000A): **Jchan, type, nnn.n**
- MTC/24 (for MultiScan/1200): **Jchan, type, nnn.n**

Wait for the command to complete. The *TRIGGER* LED indicator will flash for a few seconds.

Monitor the Calibration Status Register (**CSR**) to ensure that the *Calibrate Cold Junction Offset* (**J**) command completed without error. Refer to the *User Status* (**U**) command **U2** to monitor and decode the Calibration Status Register (**CSR**).

5. Next, send the following *Calibrate Cold Junction Offset* (**J**) command **Jchan, type, temp** for the second cold-junction channel (temperature sensor #2):

- TempTC/32B (for TempScan/1100): **Jchan+4, type, ppp.p**
- TempTC/32A (for TempScan/1000A): **Jchan+4, type, ppp.p**
- MTC/24 (for MultiScan/1200): **Jchan+8, type, ppp.p**

Wait for the command to complete. The *TRIGGER* LED indicator will flash for a few seconds.

Monitor the Calibration Status Register (**CSR**) to ensure that the *Calibrate Cold Junction Offset* (**J**) command completed without error. Refer to the *User Status* (**U**) command **U2** to monitor and decode the Calibration Status Register (**CSR**).

6. Next, send the following *Calibrate Cold Junction Offset* (**J**) command **Jchan, type, temp** for the third cold-junction channel (temperature sensor #3):

- TempTC/32B (for TempScan/1100): **Jchan+16, type, qqq.q**
- TempTC/32A (for TempScan/1000A): **Jchan+16, type, qqq.q**
- MTC/24 (for MultiScan/1200): **Jchan+16, type, qqq.q**

Wait for the command to complete. The *TRIGGER* LED indicator will flash for a few seconds.

Monitor the Calibration Status Register (**CSR**) to ensure that the *Calibrate Cold Junction Offset* (**J**) command completed without error. Refer to the *User Status* (**U**) command **U2** to monitor and decode the Calibration Status Register (**CSR**).

7. *At this point, the 3 cold-junction channels of the MTC/24 (for MultiScan/1200) scanning card have been calibrated. This additional Step applies only to the fourth cold-junction channel of the TempTC/32B (for TempScan/1100) and TempTC/32A (for TempScan/1000A) scanning cards.*

Finally, send the following *Calibrate Cold Junction Offset* (**J**) command **Jchan, type, temp** for the fourth cold-junction channel (temperature sensor #4):

- TempTC/32B (for TempScan/1100): **Jchan+20, type, rrr.r**
- TempTC/32A (for TempScan/1000A): **Jchan+20, type, rrr.r**

Wait for the command to complete. The *TRIGGER* LED indicator will flash for a few seconds.

Monitor the Calibration Status Register (**CSR**) to ensure that the *Calibrate Cold Junction Offset* (**J**) command completed without error. Refer to the *User Status* (**U**) command **U2** to monitor and decode the Calibration Status Register (**CSR**).

Calibration of Voltage Scanning Cards

Note: Prior to each calibration session, disable calibration protection by setting the rear panel DIP microswitch 9 to the up (*I*) position. Then enable *Calibration Mode* via the *Enter Calibration Mode* (**K**) command with a valid password. If the default calibration password has not been changed, enter **K12345**.

Note: At the end of each calibration session, disable *Calibration Mode* with the *End Calibration Mode* (**E**) command. Then re-enable calibration protection by resetting DIP microswitch 9 to the down (*0*) position.

To Calibrate a Voltage Card for Offset

1. Connect a Copper Short to Channel 1 on the scanning card being calibrated. Use standard copper hookup wire. *Do not use thermocouple wire.* Slide the scanning card into the previously-calibrated master chassis.
2. Power up the unit and wait at least one hour before continuing.
3. Send the *Calibrate Channel Offset* (**H**) command **Hchan** – where **chan** refers to the first channel number on the scanning card being calibrated (refer to the previous table for valid offset channel numbers) – and wait for the command to complete. The *TRIGGER* LED indicator will flash for a few seconds.
4. Monitor the Calibration Status Register (**CSR**) to ensure that the *Calibrate Channel Offset* (**H**) command completed without error. Refer to the *User Status* (**U**) command **U2** to monitor and decode the Calibration Status Register (**CSR**).

To Calibrate a Voltage Card for Gain

CAUTION



Ensure that the voltage scanning card has been calibrated for offset. If not, follow the volts card offset calibration procedure as described in the previous text.

1. Connect a precision voltage source to Channel 1 on the scanning card being calibrated. Use standard copper hookup wire. *Do not use thermocouple wire.* Slide the scanning card into the previously-calibrated master chassis.
2. Power up the unit and wait at least one hour before continuing.
3. Set the *Part A* precision voltage source and send its corresponding *Calibrate Channel Gain* (**G**) command **Gchan, type** – where **chan** refers to the first channel number on the scanning card being calibrated (refer to the previous table for valid gain channel numbers) – from the following list:
 - *Part A:* -100.0 mV DC **Gchan, 11** • *Part E:* -5.00 V DC **Gchan, 13**
 - *Part B:* +100.0 mV DC **Gchan, 11** • *Part F:* +5.00 V DC **Gchan, 13**
 - *Part C:* -1.00 V DC **Gchan, 12** • *Part G:* -10.00 V DC **Gchan, 14**
 - *Part D:* +1.00 V DC **Gchan, 12** • *Part H:* +10.00 V DC **Gchan, 14**

Wait for the *Part A* command to complete. The *TRIGGER* LED indicator will flash for a few seconds.

4. Monitor the Calibration Status Register (**CSR**) to ensure that the *Calibrate Channel Gain* (**G**) command completed without error. Refer to the *User Status* (**U**) command **U2** to monitor and decode the Calibration Status Register (**CSR**).
5. Repeat Steps 3 and 4 for each of the next seven parts: *Part B* through *Part H*.

Calibration of RTD Scanning Cards

Note: Prior to each calibration session, disable calibration protection by setting the rear panel DIP microswitch 9 to the up (*I*) position. Then enable *Calibration Mode* via the *Enter Calibration Mode* (**K**) command with a valid password. If the default calibration password has not been changed, enter **K12345**.

Note: At the end of each calibration session, disable *Calibration Mode* with the *End Calibration Mode* (**E**) command. Then re-enable calibration protection by resetting DIP microswitch 9 to the down (*O*) position.

To Calibrate an RTD Card for Offset

1. Connect a Copper Short to Channel 1 (across R1-, S1-, S1+, R1+) on the scanning card being calibrated. Use standard copper hookup wire. *Do not use thermocouple wire*. Slide the scanning card into the previously-calibrated master chassis.
2. Power up the unit and wait at least one hour before continuing.
3. Send the *Calibrate Channel Offset* (**H**) command **Hchan** – where **chan** refers to the first channel number on the scanning card being calibrated (refer to the previous table for valid offset channel numbers) – and wait for the command to complete. The *TRIGGER* LED indicator will flash for a few seconds.
4. Monitor the Calibration Status Register (**CSR**) to ensure that the *Calibrate Channel Offset* (**H**) command completed without error. Refer to the *User Status* (**U**) command **U2** to monitor and decode the Calibration Status Register (**CSR**).

To Calibrate an RTD Card for Gain

CAUTION



Ensure that the RTD scanning card has been calibrated for offset. If not, follow the RTD card offset calibration procedure as described in the previous text.

1. Connect a precision 3-wire or 4-wire resistance source of **xxx.xx** ohms to Channel 1 on the scanning card being calibrated. Slide the scanning card into the previously-calibrated master chassis.
2. Power up the unit and wait at least one hour before continuing.
3. Enter the *Set RTD Gain Calibration Reference* (***G**) command ***Ggain** where **gain** is the appropriate resistance value **nnn.nn** in ohms.
4. Send the following *Calibrate Channel Gain* (**G**) command **Gchan, type** – where **chan** refers to the first channel number on the scanning card being calibrated (refer to the previous table for valid gain channel numbers):
 - 3-Wire RTD: **Gchan, 16**
 - 4-Wire RTD: **Gchan, 17**

Wait for the command to complete. The *TRIGGER* LED indicator will flash for a few seconds.

5. Monitor the Calibration Status Register (**CSR**) to ensure that the *Calibrate Channel Gain* (**G**) command completed without error. Refer to the *User Status* (**U**) command **U2** to monitor and decode the Calibration Status Register (**CSR**).



Notes

<i>Introduction</i>	239
<i>Reading HLL Status</i>	240
<i>Reading HLL Data from Thermocouple & Volts Cards</i>	242
<i>Acquiring Pre- & Post-Trigger Data at Different Rates</i>	244
<i>Acquiring Pre- & Post-Trigger Data at the Same Rate</i>	248
<i>Operating Alarms</i>	252
<i>Using the IEEE 488 SRQ with Alarms</i>	256
<i>Acquiring Buffer Data in Binary Format</i>	260
<i>Acquiring HLL Data in Binary Format</i>	264
<i>Using Auto Re-arm to Capture Multiple Trigger Blocks</i>	268
<i>Acquiring Burst Mode Data (MultiScan/1200 Only)</i>	272

Introduction

This chapter walks through the example programs that are supplied on the release disk in the `C:\TEMPVIEW\EXAMPLES\` sub-directory. The `\EXAMPLES\` sub-directory contains separate example folders `\TEMPSCAN\` and `\MULTSCAN\` for the TempScan/1100 and MultiScan/1200 respectively, and each of these folders contains separate example sub-folders `\IEEE488\` and `\RS232\` for IEEE 488 and RS-232 applications respectively. Although written in QuickBASIC, the program logic and the TempScan/1100 or MultiScan/1200 device-dependent commands apply to all languages and computers.

These program examples use the IEEE 488 bus via the Personal488 PC/IEEE 488 controller interface to communicate with the TempScan/1100 or MultiScan/1200 unit. These programs begins with a short preamble which opens the software driver and substantiates communications. After the driver is opened, commands are issued to the driver through character strings in quotes.

The QuickBASIC `PRINT` and `INPUT` commands are used to communicate with the driver. The most-commonly used driver commands are `ENTER`, `OUTPUT`, and `SPOLL`, as follows:

- `ENTER` gets data from the selected device, The syntax of the `ENTER` command is "`ENTERaddr`", where `addr` is the IEEE 488 address of the instrument. Right after the `ENTER` command, the QuickBASIC `INPUT` function must be used to bring the data into a language variable.
- `OUTPUT` sends data to the selected device. The syntax of the `OUTPUT` command is "`OUTPUTaddr;out data`", where `addr` is the IEEE 488 address of the instrument, and `out data` is the string of characters to send to the device.
- `SPOLL` is an abbreviation for Serial Poll which retrieves an 8-bit status response from the selected instrument. The syntax of the `SPOLL` command is "`SPOLLaddr`", where `addr` is the IEEE 488 address of the instrument. Right after the `SPOLL` command, the QuickBASIC `INPUT` function must be used to bring the data into a language variable.

Note: In all of the following examples, the IEEE 488 bus address is 07.

Reading HLL Status

TempScan/1100

Example 15a. HLL32.BAS Program

```
(1)   CLS : PRINT "The TempScan/1100 is resetting..."
      PRINT #1, "OUTPUT 07;*RX"
(3)   SLEEP 4
(4)   WHILE (S% AND 4) = 0
      PRINT #1, "SPOLL 07"
      INPUT #2, S%
(7)   WEND
(8)   PRINT #1, "OUTPUT 07;C1-32,3X"
(9)   PRINT #1, "OUTPUT07;Y1,0,0X"
(10)  PRINT #1, "OUTPUT07;T1,1,0,0X"
(11)  PRINT "The TempScan/1100 is collecting HLL data for all 32 channels"
      PRINT "Hit a key to start or stop retrieving HLL data..."
(13)  WHILE INKEY$ = "": WEND
(14)  WHILE INKEY$ = ""
      PRINT #1, "OUTPUT 07;U4X"
      PRINT #1, "ENTER 07"
      LINE INPUT #2, U$
(18)  FOR i = 1 TO 32
      PRINT "High, Low and Last readings of Channel"; i
      PRINT MID$(U$, (i * 66) - 65, 66)
      NEXT i
(22)  WEND
```

This program is **HLL32.BAS** in the **\EXAMPLES** subdirectory. It will configure 32 channels, collect the High/Low/Last (HLL) Registers data, and post it on the screen.

- **Lines 1-3:** Although not necessary, it is good practice to reset the TempScan/1100 at the start of your application by sending the *Reset Power-On* (***R**) command. Wait few seconds.
- **Lines 4-7:** To be certain that the reset was successful and the device is ready, Serial Poll the device until the proper status is returned.
- **Line 8:** The *Configure Channels* (**C**) command will be used to configure a range of channels from 1 to 32 as Type T thermocouples.
- **Lines 9-10:** Program for one *Pre-Trigger* scan via the *Set Counts* (**X**) command. Then program the *Trigger* (trigger start event) and *Stop* (trigger stop event) via the *Set Trigger Configuration* (**T**) command to arm the acquisition.
- **Lines 11-13:** The next three lines tell you to hit a key to start the acquisition. The program will not proceed until a key is pressed.
- **Lines 14-22:** Until another key is pressed to exit the loop, the **U4** command is issued and the HLL data is collected. The IEEE 488 controller command **OUTPUT** sends **U4** to the TempScan/1100, the command **ENTER** requests the data, then the command **LINE INPUT** gets the data from the IEEE 488 driver and places it in the variable **U\$**. The **FOR** loop extracts the data for the individual channels from the string **U\$** and places them on the screen. Time and date information is also available in the HLL data.

MultiScan/1200

Example 15b. HLL24.BAS Program

```
(1)   CLS : PRINT "The MultiScan/1200 is resetting..."
      PRINT #1, "OUTPUT 07;*RX"
(3)   SLEEP 4
(4)   WHILE (S% AND 4) = 0
      PRINT #1, "SPOLL 07"
      INPUT #2, S%
(7)   WEND
(8)   PRINT #1, "OUTPUT 07;M#0X"
(9)   PRINT #1, "OUTPUT 07;W#32X"
(10)  PRINT #1, "OUTPUT 07;C1-24,3X"
(11)  PRINT #1,"OUTPUT07;Y1,0,0X"
(12)  PRINT #1,"OUTPUT07;T1,1,0,0X"
(13)  PRINT "The MultiScan/1200 is collecting HLL data for all 24 channels"
      PRINT "Hit a key to start or stop retrieving HLL data..."
(15)  WHILE INKEY$ = "": WEND
(16)  WHILE INKEY$ = ""
      PRINT #1, "OUTPUT 07;U4X"
      PRINT #1, "ENTER 07"
      LINE INPUT #2, U$
(20)  FOR i = 1 TO 24
      PRINT "High, Low and Last readings of Channel"; i
      PRINT MID$(U$, (i * 66) - 65, 66)
      NEXT i
(24)  WEND
```

This program is `HLL24.BAS` in the `\EXAMPLES\` subdirectory. It will configure 24 channels, collect the High/Low/Last data, and post it on the screen.

- **Lines 1-3:** Although not necessary, it is good practice to reset the MultiScan/1200 at the start of your application by sending the *Reset Power-On* (*R) command. Wait a few seconds.
- **Lines 4-7:** To be certain that the reset was successful and the device is ready, Serial Poll the device until the proper status is returned.
- **Lines 8-9:** The first thing necessary to start scanning is to setup the measuring mode. In this case, the MultiScan/1200 will be setup for line-cycle integration / high-speed multi-channel mode.
- **Line 10:** The *Configure Channels* (C) command will be used to configure a range of channels from 1 to 24 as Type T thermocouples.
- **Lines 11-12:** Program for one *Pre-Trigger* scan via the *Set Counts* (Y) command. Then program the *Trigger* (trigger start event) and *Stop* (trigger stop event) via the *Set Trigger Configuration* (T) command to arm the acquisition. Telling the MultiScan/1200 to start acquiring data is the last thing necessary to start scanning. Since the MultiScan/1200 does not scan channels until an acquisition is armed, arming an acquisition with one *Pre-Trigger* scan allows valid HLL data to be read.
- **Lines 13-15:** The next three lines tell you to hit a key to start the acquisition. The program will not proceed until a key is pressed.
- **Lines 16-24:** Until another key is pressed to exit the loop, the U4 command is issued and the HLL data is collected. The IEEE 488 controller command **OUTPUT** sends U4 to the MultiScan/1200, the command **ENTER** requests the data, then the command **LINE INPUT** gets the data from the IEEE 488 driver and places it in the variable U\$. The **FOR** loop extracts the data for the individual channels from the string U\$ and places them on the screen. Time and date information is also available in the HLL data.

Reading HLL Data from Thermocouple & Volts Cards

TempScan/1100

Example 15c. HLL64.BAS Program

```
(1)   CLS : PRINT "The TempScan/1100 is resetting..."
      PRINT #1, "OUTPUT 07;*RX"
(3)   SLEEP 4
(4)   WHILE (S% AND 4) = 0
      PRINT #1, "SPOLL 07"
      INPUT #2, S%
(7)   WEND
(8)   PRINT #1, "OUTPUT 07;C1-32,3X"
(9)   PRINT #1, "OUTPUT 07;C33-64,14X"
(10)  PRINT #1, "OUTPUT07;Y1,0,0X"
(11)  PRINT #1, "OUTPUT07;T1,1,0,0X"
(12)  PRINT "The TempScan/1100 is collecting HLL data for all 32 channels"
      PRINT "Hit a key to start or stop retrieving HLL data..."
(14)  WHILE INKEY$ = "" : WEND
(15)  WHILE INKEY$ = ""
      PRINT #1, "OUTPUT 07;U4X"
      PRINT #1, "ENTER 07"
      LINE INPUT #2, U$
(19)  FOR i = 1 TO 32
      PRINT "High, Low and Last readings of Channel"; i
      PRINT MID$(U$, (i * 66) - 65, 66)
      NEXT i
(23)  FOR i = 1 TO 32
      PRINT "High, Low and Last readings of Channel"; i + 32
      PRINT MID$(U$, (32 * 66) + (i * 78) - 77, 78)
      NEXT i
(27)  WEND
```

This program is `HLL64.BAS` in the `\EXAMPLES\` subdirectory. It will configure 32 thermocouple and 32 volts channels, collect the High/Low/Last (HLL) Registers data, and post it on the screen.

- **Lines 1-3:** Although not necessary, it is good practice to reset the TempScan/1100 at the start of your application by sending the *Reset Power-On* (***R**) command. Wait a few seconds.
- **Lines 4-7:** To be certain that the reset was successful and the device is ready, Serial Poll the device until the proper status is returned.
- **Lines 8-9:** The *Configure Channels* (**C**) command will be used once to configure a range of channels from 1 to 32 as Type T thermocouples, and used again to configure a range of channels from 33 to 64 as ± 10 volts DC inputs.
- **Lines 10-11:** Program for one *Pre-Trigger* scan via the *Set Counts* (**Y**) command. Then program the *Trigger* (trigger start event) and *Stop* (trigger stop event) via the *Set Trigger Configuration* (**T**) command to arm the acquisition.
- **Lines 12-14:** The next three lines tell you to hit a key to start the acquisition. The program will not proceed until a key is pressed.
- **Lines 15-27:** Until another key is pressed to exit the loop, the **U4** command is issued and the HLL data is collected. The IEEE 488 controller command **OUTPUT** sends **U4** to the TempScan/1100, the command **ENTER** requests the data, then the command **LINE INPUT** gets the data from the IEEE 488 driver and places it in the variable **U\$**. The **FOR** loop extracts the data for the individual channels from the string **U\$** and places them on the screen. Since the format of the volts data is subtly different than that of the thermocouple data, two different **FOR** loops must be used to extract the channel data. Time and date information is also available in the HLL data.

MultiScan/1200

Example 15d. HLL48.BAS Program

```
(1)   CLS : PRINT "The MultiScan/1200 is resetting..."
      PRINT #1, "OUTPUT 07;*RX"
(3)   SLEEP 4
(4)   WHILE (S% AND 4) = 0
      PRINT #1, "SPOLL 07"
      INPUT #2, S%
(7)   WEND
(8)   PRINT #1, "OUTPUT 07;M#0X"
(9)   PRINT #1, "OUTPUT 07;W#32X"
(10)  PRINT #1, "OUTPUT 07;C1-24,3X"
(11)  PRINT #1, "OUTPUT 07;C25-48,14X"
(12)  PRINT #1, "OUTPUT07;Y1,0,0X"
(13)  PRINT #1, "OUTPUT07;T1,1,0,0X"
(14)  PRINT "The MultiScan/1200 is collecting HLL data for all 48 channels"
      PRINT "Hit a key to start or stop retrieving HLL data..."
(16)  WHILE INKEY$ = "": WEND
(17)  WHILE INKEY$ = ""
      PRINT #1, "OUTPUT 07;U4X"
      PRINT #1, "ENTER 07"
      LINE INPUT #2, U$
(21)  FOR i = 1 TO 24
      PRINT "High, Low and Last readings of Channel"; i
      PRINT MID$(U$, (i * 66) - 65, 66)
      NEXT i
(25)  FOR i = 1 TO 24
      PRINT "High, Low and Last readings of Channel"; i + 24
      PRINT MID$(U$, (24 * 66) + (i * 78) - 77, 78)
      NEXT i
(29)  WEND
```

This program is `HLL48.BAS` in the `\EXAMPLES\` subdirectory. It will configure 24 thermocouple and 24 volts channels, collect the High/Low/Last (HLL) Registers data, and post it on the screen.

- **Lines 1-3:** Although not necessary, it is good practice to reset the MultiScan/1200 at the start of your application by sending the *Reset Power-On* (*R) command. Wait a few seconds.
- **Lines 4-7:** To be certain that the reset was successful and the device is ready, Serial Poll the device until the proper status is returned.
- **Lines 8-9:** The first thing necessary to start scanning is to setup the measuring mode. In this case, the MultiScan/1200 will be setup for line-cycle integration / high-speed multi-channel mode.
- **Lines 10-11:** The *Configure Channels* (c) command will be used once to configure a range of channels from 1 to 24 as Type T thermocouples, and used again to configure a range of channels from 25 to 48 as ± 10 volts DC inputs.
- **Lines 12-13:** Program for one *Pre-Trigger* scan via the *Set Counts* (Y) command. Then program the *Trigger* (trigger start event) and *Stop* (trigger stop event) via the *Set Trigger Configuration* (T) command to arm the acquisition. Telling the MultiScan/1200 to start acquiring data is the last thing necessary to start scanning. Since the MultiScan/1200 does not scan channels until an acquisition is armed, arming an acquisition with one *Pre-Trigger* scan allows valid HLL data to be read.
- **Lines 14-16:** The next three lines tell you to hit a key to start the acquisition. The program will not proceed until a key is pressed.

- **Lines 17-29:** Until another key is pressed to exit the loop, the **U4** command is issued and the HLL data is collected. The IEEE 488 controller command **OUTPUT** sends **U4** to the MultiScan/1200, the command **ENTER** requests the data, then the command **LINE INPUT** gets the data from the IEEE 488 driver and places it in the variable **U\$**. The **FOR** loop extracts the data for the individual channels from the string **U\$** and places them on the screen. Since the format of the volts data is subtly different than that of the thermocouple data, two different **FOR** loops must be used to extract the channel data. Time and date information is also available in the HLL data.

Acquiring Pre- & Post-Trigger Data at Different Rates

TempScan/1100

Example 15e. SLOW_ACQ.BAS Program

```

(1)   CLS : PRINT "The TempScan/1100 is resetting..."
      PRINT #1, "OUTPUT 07;*RX"
(3)   SLEEP 4
(4)   WHILE (S% AND 4) = 0
      PRINT #1, "SPOLL 07"
      INPUT #2, S%
(7)   WEND
(8)   PRINT #1, "OUTPUT 07;C1-32,1X"
(9)   PRINT #1, "OUTPUT 07;C33-64,2X"
(10)  PRINT #1, "OUTPUT 07;Y30,1,200X"
(11)  PRINT #1, "OUTPUT 07;I00:00:01.0,00:00:00.3X"
(12)  PRINT #1, "OUTPUT 07;T1,1,0,0X"
(13)  PRINT "The TempScan/1100 is collecting Pre-Trigger data and is ready
      for a Trigger..."
      PRINT "Hit a key to trigger the start of acquisition..."
      WHILE INKEY$ = "": WEND
(16)  PRINT #1, "OUTPUT 07;@X"
(17)  PRINT "The TempScan/1100 is collecting and uploading Post-Trigger data
      as it becomes available..."
      PRINT "Hit a key to trigger the stop of acquisition..."
      i = 0
(20)  WHILE INKEY$ = ""
      i = i + 1
      S% = 0
(23)  WHILE ((S% AND 8) <> 8)
      PRINT #1, "SPOLL 07"
      INPUT #2, S%
(26)  WEND
      PRINT #1 "OUTPUT 07; R1X"
      PRINT #1 "ENTER 07"
      INPUT #2, READINGS$
      LOCATE 7, 1: PRINT "The scan"; i; "was:"; READINGS$
(31)  WEND
(32)  PRINT #1, "OUTPUT 07;@X"
(33)  i = 0
      U% = 0
      WHILE INKEY$ = ""
      i = i + 1
      S% = 0
(38)  WHILE ((S% AND 8) <> 8)
      PRINT #1, "SPOLL 07"
      INPUT #2, S%
(41)  WEND

```

```

(42)          PRINT #1 "OUTPUT 07; R1X"
              PRINT #1 "ENTER 07"
              INPUT #2, READINGS$
              LOCATE 7, 1: PRINT "The scan"; i; "was:"; READINGS$
              PRINT #1, "OUTPUT 07; UOX:
              PRINT #1, :ENTER07"
              OUTPUT #2, U%
              IF U% = 1 THEN END
(50)          WEND

```

This program is `SLOW_ACQ.BAS` in the `\EXAMPLES\` subdirectory. It will configure 64 thermocouple channels, collect the data as soon as it becomes available, and post it on the screen.

- **Lines 1-3:** Although not necessary, it is good practice to reset the TempScan/1100 at the start of your application by sending the *Reset Power-On* (*R) command. Wait a few seconds.
- **Lines 4-7:** To be certain that the reset was successful and the device is ready, Serial Poll the device until the proper status is returned.
- **Lines 8-9:** The *Configure Channels* (C) command will be used once to configure a range of channels from 1 to 32 as Type J thermocouples, and used again to configure a range of channels from 33 to 64 as Type K thermocouples.
- **Line 10:** The *Set Counts* (X) command is used to configure the number of scans to take while in the different acquisition states. In this example, 30 scans will be taken while in the *Pre-Trigger* state, 1 while in the *Post-Trigger* state, and 200 while in the *Post-Stop* state. The *Post-Trigger* count is only valid when the *Stop* (trigger stop event) is set to Count via the *Set Trigger Configuration* (T) command. This example does not use Count, so this parameter is ignored.
- **Line 11:** The *Set Scan Interval* (I) command sets the time period between scans in hours-minutes-seconds format. The TempScan/1100 can have two different scan intervals, one for the *Post-Trigger* state (acquisition scan interval), and one for the *Pre-Trigger* and *Post-Stop* states (normal scan interval). This example sets up the *Post-Trigger* scan interval to 0.3 seconds (3.33 Hz), and the *Pre-Trigger* and *Post-Stop* scan intervals to 1.0 second (1.0 Hz).
- **Line 12:** The *Set Trigger Configuration* (T) command sets up the *Trigger* (trigger start event) and *Stop* (trigger stop event) parameters for the acquisition. In this example, the *Trigger* and *Stop* are both assigned the *Trigger On* (@) command character as sent by the controller. The *Auto Re-arm* flag is disabled, so that the TempScan/1100 will not re-arm itself for another acquisition after the first acquisition is complete. The synchronization flag is also disabled, so the TempScan/1100 will not re-synchronize itself to the *Trigger* point when the *Trigger* (trigger start event) begins. When the TempScan/1100 encounters the *Execute* (X) command, it will be armed and will start the collection of the *Pre-Trigger* data.
- **Lines 13-16:** The next four lines prompt you to hit a key to trigger the TempScan/1100 acquisition. When a key is hit, the *Trigger On* (@) command character is sent as the *Trigger*.
- **Lines 17-31:** While in the *Post-Trigger* state, this program will first check for an available scan via a Serial Poll of the TempScan/1100, and will then compare the response with an 8. If a scan is available, the R1 command tells the TempScan/1100 to send the oldest scan to the IEEE 488 controller. The command ENTER requests the response data from the TempScan/1100. The command INPUT places the retrieved data into the variable READINGS\$. Since the acquisition is slow and the buffer in the TempScan/1100 can be made very large, this program can go off to other foreground tasks while the TempScan/1100 is acquiring data, and only occasionally query the unit and collect its data.
- **Line 32:** When a key is hit once again to stop the current acquisition, the program proceeds to the next block where the *Trigger On* (@) command character is sent once again. This time, the character is sent as the *Stop*, ending the *Post-Trigger* state and entering the *Post-Stop* state.
- **Lines 33-50:** Now the collection of the *Post-Stop* data begins by querying for new scans and requesting the data. The program is done when the acquisition is complete.

MultiScan/1200

Example 15f. SLOW_ACQ.BAS Program

```
(1)   CLS : PRINT "The MultiScan/1200 is resetting..."
      PRINT #1, "OUTPUT 07;*RX"
(3)   SLEEP 4
(4)   WHILE (S% AND 4) = 0
      PRINT #1, "SPOLL 07"
      INPUT #2, S%
(7)   WEND
(8)   PRINT #1, "OUTPUT 07;M#0X"
(9)   PRINT #1, "OUTPUT 07;W#32X"
(10)  PRINT #1, "OUTPUT 07;C1-24,1X"
(11)  PRINT #1, "OUTPUT 07;C25-48,2X"
(12)  PRINT #1, "OUTPUT 07;Y30,1,200X"
(13)  PRINT #1, "OUTPUT 07;I00:00:03.0,00:00:02.0X"
(14)  PRINT #1, "OUTPUT 07;T1,1,0,0X"
(15)  PRINT "The MultiScan/1200 is collecting Pre-Trigger data and is ready
      for a Trigger..."
      PRINT "Hit a key to trigger the start of acquisition..."
      WHILE INKEY$ = "": WEND
(18)  PRINT #1, "OUTPUT 07;@X"
(19)  PRINT "The MultiScan/1200 is collecting and uploading Post-Trigger
      data as it becomes available..."
      PRINT "Hit a key to trigger the stop of acquisition..."
      i = 0
(22)  WHILE INKEY$ = ""
      i = i + 1
      S% = 0
(25)  WHILE ((S% AND 8) <> 8)
      PRINT #1, "SPOLL 07"
      INPUT #2, S%
(28)  WEND
      PRINT #1 "OUTPUT 07; R1X"
      PRINT #1 "ENTER 07"
      INPUT #2, READINGS$
      LOCATE 7, 1: PRINT "The scan"; i; "was:"; READINGS$
(33)  WEND
(34)  PRINT #1, "OUTPUT 07;@X"
(35)  i = 0
      U% = 0
      WHILE INKEY$ = ""
      i = i + 1
      S% = 0
(40)  WHILE ((S% AND 8) <> 8)
      PRINT #1, "SPOLL 07"
      INPUT #2, S%
(43)  WEND
      PRINT #1 "OUTPUT 07; R1X"
      PRINT #1 "ENTER 07"
      INPUT #2, READINGS$
      LOCATE 16, 1: PRINT "The scan"; i; "was:"; READINGS$
      PRINT #1, "OUTPUT 07; UOX:"
      PRINT #1, ":ENTER07"
      OUTPUT #2, U%
      IF U% = 1 THEN END
(52)  WEND
```

This program is **SLOW_ACQ.BAS** in the **\EXAMPLES** subdirectory. It will configure 48 thermocouple channels, collect the data as soon as it becomes available, and post it on the screen.

- **Lines 1-3:** Although not necessary, it is good practice to reset the MultiScan/1200 at the start of your application by sending the *Reset Power-On* (***R**) command. Wait a few seconds.
- **Lines 4-7:** To be certain that the reset was successful and the device is ready, Serial Poll the device until the proper status is returned.
- **Lines 8-9:** The first thing necessary to start scanning is to setup the measuring mode. In this case, the MultiScan/1200 will be setup for line-cycle integration / high-speed multi-channel mode.
- **Lines 10-11:** The *Configure Channels* (**C**) command will be used once to configure a range of channels from 1 to 24 as Type J thermocouples, and used again to configure a range of channels from 25 to 48 as Type K thermocouples.
- **Line 12:** The *Set Counts* (**X**) command is used to configure the number of scans to take while in the different acquisition states. In this example, 30 scans will be taken while in the *Pre-Trigger* state, 1 while in the *Post-Trigger* state, and 200 while in the *Post-Stop* state. The *Post-Trigger* count is only valid when the *Stop* (trigger stop event) is set to Count via the *Set Trigger Configuration* (**T**) command. This example does not use Count, so this parameter is ignored.
- **Line 13:** The *Set Scan Interval* (**I**) command sets the time period between scans in hours-minutes-seconds format. The MultiScan/1200 can have two different scan intervals, one for the *Post-Trigger* state (acquisition scan interval), and one for the *Pre-Trigger* and *Post-Stop* states (normal scan interval). This example sets up the *Post-Trigger* scan interval to 2.0 seconds (0.5 Hz), and the *Pre-Trigger* and *Post-Stop* scan intervals to 3.0 seconds (0.333 Hz).
- **Line 14:** The *Set Trigger Configuration* (**T**) command sets up the *Trigger* (trigger start event) and *Stop* (trigger stop event) parameters for the acquisition. In this example, the *Trigger* and *Stop* are both assigned the *Trigger On* (**@**) command character as sent by the controller. The *Auto Re-arm* flag is disabled, so that the MultiScan/1200 will not re-arm itself for another acquisition after the first acquisition is complete. The synchronization flag is also disabled, so the MultiScan/1200 will not re-synchronize itself to the *Trigger* point when the *Trigger* (trigger start event) begins. When the MultiScan/1200 encounters the *Execute* (**X**) command, it will be armed and will start the collection of the *Pre-Trigger* data.
- **Lines 15-18:** The next four lines prompt you to hit a key to trigger the MultiScan/1200 acquisition. When a key is hit, the *Trigger On* (**@**) command character is sent as the *Trigger*.
- **Lines 19-33:** While in the *Post-Trigger* state, this program will first check for an available scan via a Serial Poll of the MultiScan/1200, and will then compare the response with an 8. If a scan is available, the **R1** command tells the MultiScan/1200 to send the oldest scan to the IEEE 488 controller. The command **ENTER** requests the response data from the MultiScan/1200. The command **INPUT** places the retrieved data into the variable **READINGS\$**. Since the acquisition is slow and the buffer in the MultiScan/1200 can be made very large, this program can go off to other foreground tasks while the MultiScan/1200 is acquiring data, and only occasionally query the unit and collect its data.
- **Line 34:** When a key is hit once again to stop the current acquisition, the program proceeds to the next block where the *Trigger On* (**@**) command character is sent once again. This time, the character is sent as the *Stop*, ending the *Post-Trigger* state and entering the *Post-Stop* state.
- **Lines 35-52:** Now the collection of the *Post-Stop* data begins by querying for new scans and requesting the data. The program is done when the acquisition is complete.

Acquiring Pre- & Post-Trigger Data at the Same Rate

TempScan/1100

Example 15g. FAST_ACQ.BAS Program

```
(1)   CLS : PRINT "The TempScan/1100 is resetting..."
      PRINT #1, "OUTPUT 07;*RX"
(3)   SLEEP 10
(4)   S% = 0
      WHILE (S% AND 4) = 0
          PRINT #1, "SPOLL 07"
          INPUT #2, S%
(8)   WEND
(9)   PRINT #1, "OUTPUT 07;C1-32,3X"
(10)  PRINT #1, "OUTPUT 07;C33-48,2X"
(11)  PRINT #1, "OUTPUT 07;Y50,100,200X"
(12)  PRINT #1, "OUTPUT 07;I00:00:00.1,00:00:00.1X"
(13)  PRINT #1, "OUTPUT 07;L1,20.0,0X"
(14)  PRINT #1, "OUTPUT 07;T4,5,0,0X"
(15)  PRINT "The TempScan/1100 is collecting Pre-Trigger data and has not
      been triggered..."
      PRINT "Waiting for Channel 1 to reach the Trigger level and start the
      acquisition..."
(17)  WHILE (S% AND 2) <> 2
          PRINT #1,"SPOLL 07"
          INPUT #2, S%
      WEND
      PRINT "The Trigger level event has been detected..."
(22)  PRINT "Waiting for the Stop level event..."
(23)  WHILE (U% AND 1) <> 1
          PRINT #1,"OUTPUT 07;U0X"
          PRINT #1,"ENTER 07"
          INPUT #2, U%
      WEND
(28)  PRINT "The acquisition is now complete..."
(29)  PRINT #1, "OUTPUT 07;U6X"
      PRINT #1, "ENTER 07"
      LINE INPUT #2, U$
      PRINT U$
      UA$ = MID$(U$, 8, 6)
      UA% = VAL(UA$)
      PRINT UA%
(36)  PRINT #1, "The TempScan/1100 collected"; UA%; "scans of data."
(37)  FOR i = 1 TO UA%
          PRINT #1, "OUTPUT 07;R1X"
          PRINT #1, "ENTER 14"
          INPUT #2, SCAN$
          PRINT "Scan "; i; " is :"
          PRINT SCAN$
(43)  NEXT I
```

This program is **FAST_ACQ.BAS** in the **\EXAMPLES** subdirectory. It will configure 48 thermocouple channels, set up the TempScan/1100 for fast acquisition, and then bring the values into the controller after the acquisition is complete. From a logic standpoint, the difference between this program and the **SLOW_ACQ.BAS** program is that this **FAST_ACQ.BAS** program reads blocks of data instead of one scan at a time. This method is usually more efficient in case of fast scan intervals.

- **Lines 1-3:** Although not necessary, it is good practice to reset the TempScan/1100 at the start of your application by sending the *Reset Power-On* (***R**) command. Wait a few seconds.
- **Lines 4-8:** To be certain that the reset was successful and the device is ready, Serial Poll the device until the proper status is returned.
- **Lines 9-10:** The *Configure Channels* (**C**) command will be used once to configure a range of channels from 1 to 32 as Type T thermocouples, and used again to configure a range of channels from 33 to 48 as Type K thermocouples.
- **Line 11:** The *Set Counts* (**X**) command is used to configure the number of scans to take while in the different acquisition states. In this example, 50 scans will be taken while in the *Pre-Trigger* state, 100 while in the *Post-Trigger* state, and 200 while in the *Post-Stop* state. The *Post-Trigger* count is only valid when the *Stop* (trigger stop event) is set to Count via the *Set Trigger Configuration* (**T**) command. This example does not use Count, so this parameter is ignored.
- **Line 12:** The *Set Scan Interval* (**I**) command sets the time period between scans in hours-minutes-seconds format. The TempScan/1100 can have two different scan intervals, one for the *Post-Trigger* state (acquisition scan interval), and one for the *Pre-Trigger* and *Post-Stop* states (normal scan interval). This example sets up the *Post-Trigger*, *Pre-Trigger* and *Post-Stop* scan intervals to the same value of 0.1 second (10.0 Hz).
- **Line 13:** The *Set Trigger Level* (**L**) command specifies the channel as Channel 1 at a level of 20°C with a hysteresis of 0°C (where the default units is degrees Celsius). This command is relevant only when the *Trigger* (trigger start event) or *Stop* (trigger stop event) is a channel level, as specified on the next line.
- **Line 14:** The *Set Trigger Configuration* (**T**) command sets up the *Trigger* (trigger start event) and *Stop* (trigger stop event) parameters for the acquisition. In this example, the *Trigger* and *Stop* are assigned the rising level and falling level, respectively, of an input channel as specified via the *Set Trigger Level* (**L**) command. The *Auto Re-arm* flag is disabled, so that the TempScan/1100 will not re-arm itself for another acquisition after the first acquisition is complete. The synchronization flag is also disabled, so the TempScan/1100 will not re-synchronize itself to the *Trigger* point when the *Trigger* (trigger start event) begins. When the TempScan/1100 encounters the *Execute* (**X**) command, it will be armed and will start the collection of the *Pre-Trigger* data.
- **Lines 15-22:** After the *Execute* (**X**) command has been received, the TempScan/1100 arms itself and then waits for the *Trigger* (trigger start event) of Channel 1 rising above 20°C. The IEEE 488 Serial Poll (**SPOLL**) command is used to query the acquisition status of the TempScan/1100. A **SPOLL** value of 2 signifies that Channel 1 has in fact risen above 20°C.
- **Lines 23-28:** Using the *User Status* (**U**) command **U0** to query the Event Status Register (**ESR**), we now wait until the Acquisition Complete event is reached.
- **Lines 29-36:** During the acquisition or after the acquisition has been completed, the Acquisition Buffer can be queried for the data that is available for transfer. The *User Status* (**U**) command **U6** can be used to query the Buffer Status String, which includes the following eight fields of information: (1) Number of Trigger Blocks Available, (2) Number of Scans Available, (3) Current Position of Read Pointer, (4) Time/Date Stamping of Trigger Event, (5) Position of Stop Event Pointer, (6) Time/Date Stamping of Stop Event, (7) Position of End Scan Pointer, and (8) Status of Current Trigger Block. For more information on the Acquisition Buffer, see chapter *System Operation*.

This example uses the last parameter in the return string as an indicator of how much data is available to transfer to the IEEE 488 controller. The function **MID\$** extracts 6 characters from the string **U\$** starting at character 8.
- **Lines 37-43:** The *Read Buffered Data* (**R**) command **R1** is used to request the oldest scan from the unit. Using the variable **UA%** calculated from the previous step, all of the oldest scan data is transferred to the controller.

MultiScan/1200

Example 15h. FAST_ACQ.BAS Program

```
(1)   CLS : PRINT "The MultiScan/1200 is resetting..."
      PRINT #1, "OUTPUT 07;*RX"
(3)   SLEEP 10
(4)   S% = 0
      WHILE (S% AND 4) = 0
          PRINT #1, "SPOLL 07"
          INPUT #2, S%
(8)   WEND
(9)   PRINT #1, "OUTPUT 07;M#0X"
(10)  PRINT #1, "OUTPUT 07;W#32X"
(11)  PRINT #1, "OUTPUT 07;C1-24,3X"
(12)  PRINT #1, "OUTPUT 07;C25-48,2X"
(13)  PRINT #1, "OUTPUT 07;Y50,100,200X"
(14)  PRINT #1, "OUTPUT 07;I00:00:00.0,00:00:00.0X"
(15)  PRINT #1, "OUTPUT 07;L1,20.0,0X"
(16)  PRINT #1, "OUTPUT 07;T4,5,0,0X"
(17)  PRINT "The MultiScan/1200 is collecting Pre-Trigger data and has not
      been triggered..."
      PRINT "Waiting for Channel 1 to reach the Trigger level and start the
      acquisition..."
(19)  WHILE (S% AND 2) <> 2
          PRINT #1,"SPOLL 07"
          INPUT #2, S%
      WEND
      PRINT "The Trigger level event has been detected..."
(24)  PRINT "Waiting for the Stop level event..."
(25)  WHILE (U% AND 1) <> 1
          PRINT #1,"OUTPUT 07;U0X"
          PRINT #1,"ENTER 07"
          INPUT #2, U%
      WEND
(30)  PRINT "The acquisition is now complete..."
(31)  PRINT #1, "OUTPUT 07;U6X"
      PRINT #1, "ENTER 07"
      LINE INPUT #2, U$
      PRINT U$
      UA$ = MID$(U$, 9, 7)
      UA% = VAL(UA$)
      PRINT UA%
(38)  PRINT #1, "The MultiScan/1200 collected"; UA%; "scans of data."
(39)  FOR i = 1 TO UA%
          PRINT #1, "OUTPUT 07;R1X"
          PRINT #1, "ENTER 14"
          INPUT #2, SCAN$
          PRINT "Scan "; i; " is :"
          PRINT SCAN$
(45)  NEXT i
```

This program is **FAST_ACQ.BAS** in the **\EXAMPLES** subdirectory. It will configure 48 thermocouple channels, set up the MultiScan/1200 for fast acquisition, and then bring the values into the controller after the acquisition is complete. From a logic standpoint, the difference between this program and the **SLOW_ACQ.BAS** program is that this **FAST_ACQ.BAS** program reads blocks of data instead of one scan at a time. This method is usually more efficient in case of fast scan intervals.

- **Lines 1-3:** Although not necessary, it is good practice to reset the MultiScan/1200 at the start of your application by sending the *Reset Power-On* (***R**) command. Wait a few seconds.
- **Lines 4-8:** To be certain that the reset was successful and the device is ready, Serial Poll the device until the proper status is returned.
- **Lines 9-10:** The first thing necessary to start scanning is to setup the measuring mode. In this case, the MultiScan/1200 will be setup for line-cycle integration / high-speed multi-channel mode.
- **Lines 11-12:** The *Configure Channels* (**C**) command will be used once to configure a range of channels from 1 to 24 as Type T thermocouples, and used again to configure a range of channels from 25 to 48 as Type K thermocouples.
- **Line 13:** The *Set Counts* (**X**) command is used to configure the number of scans to take while in the different acquisition states. In this example, 50 scans will be taken while in the *Pre-Trigger* state, 100 while in the *Post-Trigger* state, and 200 while in the *Post-Stop* state. The *Post-Trigger* count is only valid when the *Stop* (trigger stop event) is set to Count via the *Set Trigger Configuration* (**T**) command. This example does not use Count, so this parameter is ignored.
- **Line 14:** The *Set Scan Interval* (**I**) command sets the time period between scans in hours-minutes-seconds format. The MultiScan/1200 can have two different scan intervals, one for the *Post-Trigger* state (acquisition scan interval), and one for the *Pre-Trigger* and *Post-Stop* states (normal scan interval). This example sets up the *Post-Trigger*, *Pre-Trigger* and *Post-Stop* scan intervals to the same value of 0.0 second, which defaults the MultiScan/1200 acquisition to fast mode.
- **Line 15:** The *Set Trigger Level* (**L**) command specifies the channel as Channel 1 at a level of 20°C with a hysteresis of 0°C (where the default units is degrees Celsius). This command is relevant only when the *Trigger* (trigger start event) or *Stop* (trigger stop event) is a channel level, as specified on the next line.
- **Line 16:** The *Set Trigger Configuration* (**T**) command sets up the *Trigger* (trigger start event) and *Stop* (trigger stop event) parameters for the acquisition. In this example, the *Trigger* and *Stop* are assigned the rising level and falling level, respectively, of an input channel as specified via the *Set Trigger Level* (**L**) command. The *Auto Re-arm* flag is disabled, so that the MultiScan/1200 will not re-arm itself for another acquisition after the first acquisition is complete. The synchronization flag is also disabled, so the MultiScan/1200 will not re-synchronize itself to the *Trigger* point when the *Trigger* (trigger start event) begins. When the MultiScan/1200 encounters the *Execute* (**X**) command, it will be armed and will start the collection of the *Pre-Trigger* data.
- **Lines 17-24:** After the *Execute* (**X**) command has been received, the MultiScan/1200 arms itself and then waits for the *Trigger* (trigger start event) of Channel 1 rising above 20°C. The IEEE 488 Serial Poll (**SPOLL**) command is used to query the acquisition status of the MultiScan/1200. A **SPOLL** value of 2 signifies that Channel 1 has in fact risen above 20°C.
- **Lines 25-30:** Using the *User Status* (**U**) command **U0** to query the Event Status Register (**ESR**), we now wait until the Acquisition Complete event is reached.
- **Lines 31-38:** During the acquisition or after the acquisition has been completed, the Acquisition Buffer can be queried for the data that is available for transfer. The *User Status* (**U**) command **U6** can be used to query the Buffer Status String, which includes the following eight fields of information: (1) Number of Trigger Blocks Available, (2) Number of Scans Available, (3) Current Position of Read Pointer, (4) Time/Date Stamping of Trigger Event, (5) Position of Stop Event Pointer, (6) Time/Date Stamping of Stop Event, (7) Position of End Scan Pointer, and (8) Status of Current Trigger Block. For more Acquisition Buffer information, see chapter *System Operation*.

This example uses the last parameter in the return string as an indicator of how much data is available to transfer to the IEEE 488 controller. The function **MID\$** extracts 7 characters from the string **U\$** starting at character 9.
- **Lines 39-45:** The *Read Buffered Data* (**R**) command **R1** is used to request the oldest scan from the unit. Using the variable **UA%** calculated from the previous step, all of the oldest scan data is transferred to the controller.

Operating Alarms

TempScan/1100

Example 15i. ALARM2.BAS Program

```
(1)   CLS : PRINT "The TempScan/1100 is resetting..."
      PRINT #1, "OUTPUT 07;*RX"
(3)   SLEEP 10
(4)   S% = 0
      WHILE (S% AND 4) = 0
          PRINT #1, "SPOLL 07"
          INPUT #2, S%
(8)   WEND
(9)   PRINT #1, "OUTPUT 07;C1-32,3,1,18,0X"
(10)  PRINT #1, "OUTPUT 07;A1-2,1X"
(11)  PRINT #1, "OUTPUT07;Y1,0,0X"
(12)  PRINT #1, "OUTPUT07;T1,1,0,0X"
(13)  WHILE INKEY$ = ""
      PRINT #1, "OUTPUT 07;O?X"
      PRINT #1, "ENTER 07"
      LINE INPUT #2, O$
(17)  IF MID$(O$, 2, 3) = "001" THEN
      PRINT "Channel 1 OR 2 is in an Alarm condition."
      PRINT #1, "OUTPUT 07;U11X"
      PRINT #1, "ENTER 07"
      LINE INPUT #2, A$
      PRINT A$
(23)  IF MID$(A$, 5, 1) = "1" THEN
          PRINT "Channel 1 is now in an Alarm condition.":
      ELSE
          PRINT "Channel 1 is not in an Alarm condition."
      END IF
(28)  IF MID$(A$, 11, 1) = "1" THEN
          PRINT "Channel 2 is now in an Alarm condition.":
      ELSE
          PRINT "Channel 2 is not in an Alarm condition."
      END IF
      END IF
(34)  WEND
```

The following program is **ALARM2.BAS** in the **\EXAMPLES** subdirectory. It will set up the alarm system of the TempScan/1100.

- **Lines 1-3:** Although not necessary, it is good practice to reset the TempScan/1100 at the start of your application by sending the *Reset Power-On (*R)* command. Wait a few seconds.
- **Lines 4-8:** To be certain that the reset was successful and the device is ready, Serial Poll the device until the proper status is returned.
- **Line 9:** The *Configure Channels (C)* command will be used once to configure a range of channels from 1 to 32 as Type T thermocouples, where levels above 18 or below 1 will cause a system alarm.
- **Line 10:** In addition to causing an internal system alarm state, the alarm conditions can also be attached to any one of the 32 digital output lines. The *Assign Digital Alarm Output (A)* command will be used to assign input Channels 1 and 2 to digital alarm Output 1 in an *ORed* fashion.
- **Lines 11-12:** Program for one *Pre-Trigger* scan via the *Set Counts (Y)* command. Then program the *Trigger* (trigger start event) and *Stop* (trigger stop event) via the *Set Trigger Configuration (T)* command to arm the acquisition.
- **Lines 13-34:** The *Set Digital Outputs (O)* command *O?* will be used to query the status of the digital output lines. The alarm state can be detected since digital alarm Output 1 was mapped into input Channels 1 and 2. This example shows alarm detection handling when two or more channels have to be muxed into one single digital output bit.

The *User Status (U)* command *U11* will be used to show each individual channel alarm status.

MultiScan/1200

Example 15j. ALARM2.BAS Program

```
(1)   CLS : PRINT "The MultiScan/1200 is resetting..."
      PRINT #1, "OUTPUT 07;*RX"
(3)   SLEEP 10
(4)   S% = 0
      WHILE (S% AND 4) = 0
          PRINT #1, "SPOLL 07"
          INPUT #2, S%
(8)   WEND
(9)   PRINT #1, "OUTPUT 07;M#0X"
(10)  PRINT #1, "OUTPUT 07;W#32X"
(11)  PRINT #1, "OUTPUT 07;C1-24,3,1,18,0X"
(12)  PRINT #1, "OUTPUT 07;A1-2,1X"
(13)  PRINT #1, "OUTPUT07;Y1,0,0X"
(14)  PRINT #1, "OUTPUT07;T1,1,0,0X"
(15)  WHILE INKEY$ = ""
      PRINT #1, "OUTPUT 07;O?X"
      PRINT #1, "ENTER 07"
      LINE INPUT #2, O$
(19)  IF MID$(O$, 2, 3) = "001" THEN
      PRINT "Channel 1 OR 2 is in an Alarm condition."
      PRINT #1, "OUTPUT 07;U11X"
      PRINT #1, "ENTER 07"
      LINE INPUT #2, A$
      PRINT A$
(25)  IF MID$(A$, 5, 1) = "1" THEN
          PRINT "Channel 1 is now in an Alarm condition.":
      ELSE
          PRINT "Channel 1 is not in an Alarm condition."
      END IF
(30)  IF MID$(A$, 11, 1) = "1" THEN
          PRINT "Channel 2 is now in an Alarm condition.":
      ELSE
          PRINT "Channel 2 is not in an Alarm condition."
      END IF
      END IF
(36)  WEND
```

The following program is **ALARM2.BAS** in the **\EXAMPLES** subdirectory. It will set up the alarm system of the MultiScan/1200.

- **Lines 1-3:** Although not necessary, it is good practice to reset the MultiScan/1200 at the start of your application by sending the *Reset Power-On (*R)* command. Wait a few seconds.
- **Lines 4-8:** To be certain that the reset was successful and the device is ready, Serial Poll the device until the proper status is returned.
- **Lines 9-10:** The first thing necessary to start scanning is to setup the measuring mode. In this case, the MultiScan/1200 will be setup for line-cycle integration / high-speed multi-channel mode.
- **Line 11:** The *Configure Channels (C)* command will be used once to configure a range of channels from 1 to 24 as Type T thermocouples, where levels above 18 or below 1 will cause a system alarm.
- **Line 12:** In addition to causing an internal system alarm state, the alarm conditions can also be attached to any one of the 32 digital output lines. The *Assign Digital Alarm Output (A)* command will be used to assign input Channels 1 and 2 to digital alarm Output 1 in an *ORed* fashion.
- **Lines 13-14:** Program for one *Pre-Trigger* scan via the *Set Counts (Y)* command. Then program the *Trigger* (trigger start event) and *Stop* (trigger stop event) via the *Set Trigger Configuration (T)* command to arm the acquisition.
- **Lines 15-36:** The *Set Digital Outputs (O)* command *O?* will be used to query the status of the digital output lines. The alarm state can be detected since digital alarm Output 1 was mapped into input Channels 1 and 2. This example shows alarm detection handling when two or more channels have to be muxed into one single digital output bit.

The *User Status (U)* command *U11* will be used to show each individual channel alarm status.

Using the IEEE 488 SRQ with Alarms

TempScan/1100

Example 15k. ALAR2SRQ.BAS Program

```
(1)   CLS : PRINT "The TempScan/1100 is resetting..."
      PRINT #1, "OUTPUT 07;*RX"
(3)   SLEEP 10
(4)   S% = 0
      WHILE (S% AND 4) = 0
          PRINT #1, "SPOLL 07"
          INPUT #2, S%
(8)   WEND
(9)   ON PEN GOSUB AlarmHandler
      PEN ON
(10)  PRINT #1, "ARM SRQ"
(11)  PRINT #1, "OUTPUT 07;M1X"
(12)  PRINT #1, "OUTPUT 07;C1-32,3X"
(13)  PRINT #1, "OUTPUT 07;C1-2,3,1,25,0X"
(14)  PRINT #1, "OUTPUT 07;A1,1X"
(15)  PRINT #1, "OUTPUT 07;A2,2X"
(16)  PRINT #1, "OUTPUT07;Y1,0,0X"
(17)  PRINT #1, "OUTPUT07;T1,1,0,0X"
(18)  PRINT "The program is continuously detecting Alarms..."
      PRINT "Hit a key to Quit.."
      WHILE INKEY$ = "": WEND
      END
(22)  AlarmHandler:
      LOCATE 5, 1
      PRINT "An Alarm condition has been detected."
      PRINT #1, "SPOLL 07"
      INPUT #2, S%
(27)  PRINT #1, "OUTPUT 07;O?X"
      PRINT #1, "ENTER 07"
      LINE INPUT #2, A$
(30)  PRINT A$
      A% = VAL(MID$(A$, 2, 3))
      IF A% = 1 THEN PRINT "Alarm on Channel 1 only"
      IF A% = 2 THEN PRINT "Alarm on Channel 2 only"
      IF A% = 3 THEN PRINT "Alarm on Channels 1 and 2"
(35)  RETURN
```

The following program is **ALAR2SRQ.BAS** in the **\EXAMPLES** subdirectory. It will set up the alarm system of the TempScan/1100, and then it will use the IEEE 488 Service Request signal to asynchronously service the event.

- **Lines 1-3:** Although not necessary, it is good practice to reset the TempScan/1100 at the start of your application by sending the *Reset Power-On* (***R**) command. Wait a few seconds.
- **Lines 4-8:** To be certain that the reset was successful and the device is ready, Serial Poll the device until the proper status is returned.
- **Lines 9-10:** The PC/IEEE 488 controller interface and driver software provides a means for QuickBASIC to asynchronously service the IEEE 488 **SRQ** interrupt through its **ON PEN GOSUB** command. When an **SRQ** is detected by the controller, program control is automatically vectored to the subroutine named in the **ON PEN GOSUB** command. To activate this feature in the IEEE 488 driver, the command **ARM SRQ** must be sent to the driver.
- **Line 11:** The *Set SRQ Mask* (**M**) command **M1** instructs the TempScan/1100 unit to assert the **SRQ** signal when it is in an alarm state.
- **Lines 12-13:** The *Configure Channels* (**C**) command will be used once to configure a range of channels from 1 to 32 as Type T thermocouples, and used again to configure Channels 1 and 2 such that levels above 25 or below 1 will cause a system alarm. Once the **C** command is issued, the TempScan/1100 will be completely armed for alarming. Since the **M1** command has already been issued, this will also result in an IEEE 488 **SRQ** assertion.
- **Line 14-15:** In addition to causing an internal system alarm state, the alarm conditions can also be attached to any one of the 32 digital output lines. The *Assign Digital Alarm Output* (**A**) command will be used to assign input Channel 1 to digital alarm Output 1, and Channel 2 to Output 2, individually.
- **Lines 16-17:** Program for one *Pre-Trigger* scan via the *Set Counts* (**Y**) command. Then program the *Trigger* (trigger start event) and *Stop* (trigger stop event) via the *Set Trigger Configuration* (**T**) command to arm the acquisition.
- **Lines 18-35:** This example now processes a loop that is waiting for a key press in order to exit. If an **SRQ** is detected by the IEEE 488 driver, program control will be automatically vectored to the **AlarmHandler** subroutine, then returned to the wait loop again. In the alarm service routine, the TempScan/1100 unit is first Serial Polled (**SPOLLED**) to clear the **SRQ** signal. The *Set Digital Outputs* (**O**) command **O?** will be used to query the status of the digital output lines. In turn, the channel number that is in the alarm state can be identified.

MultiScan/1200

Example 15I. ALAR2SRQ.BAS Program

```
(1)   CLS : PRINT "The MultiScan/1200 is resetting..."
      PRINT #1, "OUTPUT 07;*RX"
(3)   SLEEP 10
(4)   S% = 0
      WHILE (S% AND 4) = 0
            PRINT #1, "SPOLL 07"
            INPUT #2, S%
(8)   WEND
(9)   ON PEN GOSUB AlarmHandler
      PEN ON
(10)  PRINT #1, "ARM SRQ"
(11)  PRINT #1, "OUTPUT 07;M1X"
(12)  PRINT #1, "OUTPUT 07;M#0X"
(13)  PRINT #1, "OUTPUT 07;W#32X"
(14)  PRINT #1, "OUTPUT 07;C1-24,3X"
(15)  PRINT #1, "OUTPUT 07;C1-2,3,1,25,0X"
(16)  PRINT #1, "OUTPUT 07;A1,1X"
(17)  PRINT #1, "OUTPUT 07;A2,2X"
(18)  PRINT #1, "OUTPUT07;Y1,0,0X"
(19)  PRINT #1, "OUTPUT07;T1,1,0,0X"
(20)  PRINT "The program is continuously detecting Alarms..."
      PRINT "Hit a key to Quit.."
      WHILE INKEY$ = "": WEND
      END
(24)  AlarmHandler:
      LOCATE 5, 1
      PRINT "An Alarm condition has been detected."
      PRINT #1, "SPOLL 07"
      INPUT #2, S%
(29)  PRINT #1, "OUTPUT 07;O?X"
      PRINT #1, "ENTER 07"
      LINE INPUT #2, A$
(32)  PRINT A$
      A% = VAL(MID$(A$, 2, 3))
      IF A% = 1 THEN PRINT "Alarm on Channel 1 only"
      IF A% = 2 THEN PRINT "Alarm on Channel 2 only"
      IF A% = 3 THEN PRINT "Alarm on Channels 1 and 2"
(37)  RETURN
```

The following program is **ALAR2SRQ.BAS** in the **\EXAMPLES** subdirectory. It will set up the alarm system of the MultiScan/1200, and then it will use the IEEE 488 Service Request signal to asynchronously service the event.

- **Lines 1-3:** Although not necessary, it is good practice to reset the MultiScan/1200 at the start of your application by sending the *Reset Power-On* (***R**) command. Wait a few seconds.
- **Lines 4-8:** To be certain that the reset was successful and the device is ready, Serial Poll the device until the proper status is returned.
- **Lines 9-10:** The PC/IEEE 488 controller interface and driver software provides a means for QuickBASIC to asynchronously service the IEEE 488 **SRQ** interrupt through its **ON PEN GOSUB** command. When an **SRQ** is detected by the controller, program control is automatically vectored to the subroutine named in the **ON PEN GOSUB** command. To activate this feature in the IEEE 488 driver, the command **ARM SRQ** must be sent to the driver.
- **Line 11:** The *Set SRQ Mask* (**M**) command **M1** instructs the MultiScan/1200 unit to assert the **SRQ** signal when it is in an alarm state.
- **Lines 12-13:** The first thing necessary to start scanning is to setup the measuring mode. In this case, the MultiScan/1200 will be setup for line-cycle integration / high-speed multi-channel mode.
- **Lines 14-15:** The *Configure Channels* (**C**) command will be used once to configure a range of channels from 1 to 24 as Type T thermocouples, and used again to configure Channels 1 and 2 such that levels above 25 or below 1 will cause a system alarm. Once the **C** command is issued, the MultiScan/1200 will be completely armed for alarming. Since the **M1** command has already been issued, this will also result in an IEEE 488 **SRQ** assertion.
- **Line 16-17:** In addition to causing an internal system alarm state, the alarm conditions can also be attached to any one of the 32 digital output lines. The *Assign Digital Alarm Output* (**A**) command will be used to assign input Channel 1 to digital alarm Output 1, and Channel 2 to Output 2, individually.
- **Lines 18-19:** Program for one *Pre-Trigger* scan via the *Set Counts* (**Y**) command. Then program the *Trigger* (trigger start event) and *Stop* (trigger stop event) via the *Set Trigger Configuration* (**T**) command to arm the acquisition.
- **Lines 20-37:** This example now processes a loop that is waiting for a key press in order to exit. If an **SRQ** is detected by the IEEE 488 driver, program control will be automatically vectored to the **AlarmHandler** subroutine, then returned to the wait loop again. In the alarm service routine, the MultiScan/1200 unit is first Serial Polled (**SPOLLED**) to clear the **SRQ** signal. The *Set Digital Outputs* (**O**) command **O?** will be used to query the status of the digital output lines. In turn, the channel number that is in the alarm state can be identified.

Acquiring Buffer Data in Binary Format

TempScan/1100

Example 15m. BIN_ACQ.BAS Program

```
(1)   CLS : PRINT "The TempScan/1100 is resetting..."
      PRINT #1, "OUTPUT 07;*RX"
(3)   SLEEP 10
(4)   S% = 0
      WHILE (S% AND 4) = 0
          PRINT #1, "SPOLL 07"
          INPUT #2, S%
(8)   WEND
(9)   PRINT #1, "OUTPUT 07;C1-16,3X"
(10)  PRINT #1, "OUTPUT 07;C33-48,2X"
(11)  PRINT #1, "OUTPUT 07;Y400,100,200X"
(12)  PRINT #1, "OUTPUT 07;I00:00:00.0,00:00:00.0X"
(13)  PRINT #1, "OUTPUT 07;T1,8,0,0X"
(14)  PRINT "The TempScan/1100 is collecting Pre-Trigger data and has not
      been triggered..."
      PRINT "Hit a key to trigger the start of acquisition..."
      WHILE INKEY$ = "": WEND
      PRINT #1, "OUTPUT 07;@X"
(18)  WHILE (S% AND 2) <> 2
          PRINT #1,"SPOLL 07"
          INPUT #2, S%
      WEND
      PRINT "The Trigger has been detected..."
(23)  PRINT "Waiting for the acquisition to complete, including Post-Stop
      Scans..."
(24)  WHILE (E% AND 1) <> 1
          PRINT #1,"OUTPUT 07;U0X"
          PRINT #1,"ENTER 07"
          INPUT #2, E%
      WEND
(29)  PRINT "The acquisition is now complete..."
(30)  PRINT #1, "OUTPUT 07;F0,1X"
(31)  PRINT #1, "OUTPUT 07;U6X"
      PRINT #1, "ENTER 07"
      LINE INPUT #2, U$
      PRINT U$
      UA$ = MID$(U$, 8, 6)
      UA% = VAL(UA$)
      PRINT UA%
(38)  PRINT #1, "The TempScan/1100 collected"; UA%; "scans of data."
(39)  CHANNELS = 32
      DIM CBUFFER%(UA% * CHANNELS)
      SE% = VARSEG(CBUFFER%(0))
      OF% = VARPTR(CBUFFER%(0))
      B& = UA% * CHANNELS * 2
      PRINT "Total number of bytes available : "; B&
      PRINT #1, "OUTPUT 07;R2X"
      PRINT "Uploading data.."
      WHILE INKEY$ = "": WEND
(48)  PRINT #1, "ENTER 07 #"; B&; "BUFFER"; SE%; " : "; OF%; "DMA"
(49)  BINARY DATA%/10 = °C
```

The following program is **BIN_ACQ.BAS** in the **\EXAMPLES** subdirectory. It will configure 32 thermocouple channels, set up the TempScan/1100 for acquisition, and then after the acquisition is complete, collect the buffered channel readings in a Binary format rather than the default ASCII format. The Binary format is inherently faster than ASCII format, but the data must be deciphered after it is collected in order to yield the temperature values.

- **Lines 1-3:** Although not necessary, it is good practice to reset the TempScan/1100 at the start of your application by sending the *Reset Power-On* (***R**) command. Wait a few seconds.
- **Lines 4-8:** To be certain that the reset was successful and the device is ready, Serial Poll the device until the proper status is returned.
- **Lines 9-10:** The *Configure Channels* (**C**) command will be used once to configure a range of channels from 1 to 16 as Type T thermocouples, and used again to configure a range of channels from 33 to 48 as Type K thermocouples.
- **Line 11:** The *Set Counts* (**Y**) command is used to configure the number of scans to take while in the different acquisition states. In this example, 400 scans will be taken while in the *Pre-Trigger* state, 100 while in the *Post-Trigger* state, and 200 while in the *Post-Stop* state. The *Post-Trigger* count is only valid when the *Stop* (trigger stop event) is set to Count via the *Set Trigger Configuration* (**T**) command. This example will in fact use Count, so this parameter is valid.
- **Line 12:** The *Set Scan Interval* (**I**) command sets the time period between scans in hours-minutes-seconds format. The TempScan/1100 can have two different scan intervals, one for the *Post-Trigger* state (acquisition scan interval), and one for the *Pre-Trigger* and *Post-Stop* states (normal scan interval). This example sets up the *Post-Trigger*, *Pre-Trigger* and *Post-Stop* scan intervals to the same value of 0.0 second, which defaults the TempScan/1100 acquisition to fast mode.
- **Line 13:** The *Set Trigger Configuration* (**T**) command sets up the *Trigger* (trigger start event) and *Stop* (trigger stop event) parameters for the acquisition. In this example, the *Trigger* is assigned the *Trigger On* (**@**) command character as sent by the controller, while the *Stop* is assigned to Count. Both the *Auto Re-arm* flag and the synchronization flag are disabled, as described in previous examples. When the TempScan/1100 encounters the *Execute* (**X**) command, it will be armed and will start the collection of the *Pre-Trigger* data.
- **Lines 14-23:** After the last *Execute* (**X**) command has been received, the TempScan/1100 arms itself and then waits for the *Trigger* (trigger start event). The IEEE 488 Serial Poll (**SPOLL**) command is used to query the acquisition status of the TempScan/1100. A **SPOLL** value of 2 signifies that the TempScan/1100 has detected the *Trigger*.
- **Lines 24-29:** Using the *User Status* (**U**) command **U0** to query the Event Status Register (**ESR**), we now wait until the Acquisition Complete event is reached.
- **Line 30:** Before reading the data, the *Set Data Format* (**F**) command is sent, instructing the TempScan/1100 to return the data in Binary format where every value will be 2 bytes in length. This command can be issued anytime after the initial reset, and stays in effect until the unit is reset again or another **F** command is issued.
- **Lines 31-38:** During the acquisition or after the acquisition has been completed, the buffer can be queried for the data available for transfer. The *User Status* (**U**) command **U6** can be used to query the Buffer Status String, as described in previous examples. This example uses the last parameter in the return string as an indicator of how much data is available to transfer to the IEEE 488 controller. The function **MID\$** extracts 6 characters from the string **U\$** starting at character 8.
- **Lines 39-48:** After calculating the number of scans, an integer-type buffer is then prepared for the data. The offset and segment pointers are supplied to the IEEE 488 driver so that the data can be transferred using DMA (Direct Memory Access). The *Read Buffered Data* (**R**) command **R2** instructs the TempScan/1100 to supply the oldest complete *Trigger Block* of data that is currently available.
- **Line 49:** At the completion of the DMA transfer, the integer data is now in the buffer **BUFFER%**. To convert the integer data into temperatures, a simple calculation is performed.

MultiScan/1200

Example 15n. BIN_ACQ.BAS Program

```
(1)   CLS : PRINT "The MultiScan/1200 is resetting..."
      PRINT #1, "OUTPUT 07;*RX"
(3)   SLEEP 10
(4)   S% = 0
      WHILE (S% AND 4) = 0
          PRINT #1, "SPOLL 07"
          INPUT #2, S%
(8)   WEND
(9)   PRINT #1, "OUTPUT 07;M#0X"
(10)  PRINT #1, "OUTPUT 07;W#32X"
(11)  PRINT #1, "OUTPUT 07;C1-12,3X"
(12)  PRINT #1, "OUTPUT 07;C25-36,14X"
(13)  PRINT #1, "OUTPUT 07;Y400,100,200X"
(14)  PRINT #1, "OUTPUT 07;I00:00:00.0,00:00:00.0X"
(15)  PRINT #1, "OUTPUT 07;T1,8,0,0X"
(16)  PRINT "The MultiScan/1200 is collecting Pre-Trigger data and has not
      been triggered..."
      PRINT "Hit a key to trigger the start of acquisition..."
      WHILE INKEY$ = "": WEND
      PRINT #1, "OUTPUT 07;@X"
(20)  WHILE (S% AND 2) <> 2
          PRINT #1,"SPOLL 07"
          INPUT #2, S%
      WEND
      PRINT "The Trigger has been detected..."
(25)  PRINT "Waiting for the acquisition to complete, including Post-Stop
      Scans..."
(26)  WHILE (E% AND 1) <> 1
          PRINT #1,"OUTPUT 07;U0X"
          PRINT #1,"ENTER 07"
          INPUT #2, E%
      WEND
(31)  PRINT "The acquisition is now complete..."
(32)  PRINT #1, "OUTPUT 07;F0,1X"
(33)  PRINT #1, "OUTPUT 07;U6X"
      PRINT #1, "ENTER 07"
      LINE INPUT #2, U$
      PRINT U$
      UA$ = MID$(U$, 9, 7)
      UA% = VAL(UA$)
      PRINT UA%
(40)  PRINT #1, "The MultiScan/1200 collected"; UA%; "scans of data."
(41)  CHANNELS = 24
      DIM CBUFFER%(UA% * CHANNELS)
      SE% = VARSEG(CBUFFER%(0))
      OF% = VARPTR(CBUFFER%(0))
      B& = UA% * CHANNELS * 2
      PRINT "Total number of bytes available : "; B&
      PRINT #1, "OUTPUT 07;R2X"
      PRINT "Uploading data.."
      WHILE INKEY$ = "": WEND
(50)  PRINT #1, "ENTER 07 #"; B&; "BUFFER"; SE%; " : "; OF%; "DMA"
(51)  BINARY DATA%/10 = °C
(52)  BINARY DATA%/3276.7 = V (±10 V DC)
```

The following program is **BIN_ACQ.BAS** in the `\EXAMPLES\` subdirectory. It will configure 12 thermocouple and 12 volts channels, set up the MultiScan/1200 for acquisition, and then after the acquisition is complete, collect the buffered channel readings in a Binary format rather than the default ASCII format. The Binary format is inherently faster than ASCII format, but the data must be deciphered after it is collected in order to yield the temperature values.

- **Lines 1-3:** Although not necessary, it is good practice to reset the MultiScan/1200 at the start of your application by sending the *Reset Power-On* (***R**) command. Wait a few seconds.
- **Lines 4-8:** To be certain that the reset was successful and the device is ready, Serial Poll the device until the proper status is returned.
- **Lines 9-10:** The first thing necessary to start scanning is to setup the measuring mode. In this case, the MultiScan/1200 will be setup for line-cycle integration / high-speed multi-channel mode.
- **Lines 11-12:** The *Configure Channels* (**C**) command will be used once to configure a range of channels from 1 to 12 as Type T thermocouples, and used again to configure a range of channels from 25 to 36 as 10-Volt DC inputs.
- **Line 13:** Using the *Set Counts* (**Y**) command, 400 scans will be taken while in the *Pre-Trigger* state, 100 while in the *Post-Trigger* state, and 200 while in the *Post-Stop* state. The *Post-Trigger* count is only valid when the *Stop* (trigger stop event) is set to Count via the *Set Trigger Configuration* (**T**) command. This example will in fact use Count, so this parameter is valid.
- **Line 14:** Using the *Set Scan Interval* (**I**) command, the *Post-Trigger*, *Pre-Trigger* and *Post-Stop* scan intervals are set to the same value of 0.0 second, which defaults the MultiScan/1200 acquisition to fast mode.
- **Line 15:** Using the *Set Trigger Configuration* (**T**) command, the *Trigger* (trigger start event) is assigned the *Trigger On* (**@**) command character as sent by the controller, while the *Stop* (trigger stop event) is assigned to Count. Both the *Auto Re-arm* flag and the synchronization flag are disabled, as described in previous examples. When the MultiScan/1200 encounters the *Execute* (**X**) command, it will be armed and will start the collection of the *Pre-Trigger* data.
- **Lines 16-25:** After the last *Execute* (**X**) command has been received, the MultiScan/1200 arms itself and then waits for the *Trigger* (trigger start event). The IEEE 488 Serial Poll (**SPOLL**) command is used to query the acquisition status of the MultiScan/1200. A **SPOLL** value of 2 signifies that the MultiScan/1200 has detected the *Trigger*.
- **Lines 26-31:** Using the *User Status* (**U**) command **U0** to query the Event Status Register (**ESR**), we now wait until the Acquisition Complete event is reached.
- **Line 32:** Before reading the data, the *Set Data Format* (**F**) command is sent, instructing the MultiScan/1200 to return the data in Binary format where every value will be 2 bytes in length. This command can be issued anytime after the initial reset, and stays in effect until the unit is reset again or another **F** command is issued.
- **Lines 33-40:** During the acquisition or after the acquisition has been completed, the Acquisition Buffer can be queried for the data that is available for transfer. The *User Status* (**U**) command **U6** can be used to query the Buffer Status String, as described in previous examples. This example uses the last parameter of the return string as an indicator of how much data is available to transfer to the IEEE 488 controller. The function **MID\$** extracts 7 characters from the string **U\$** starting at character 9.
- **Lines 41-50:** After calculating the number of scans, an integer-type buffer is then prepared for the data. The offset and segment pointers are supplied to the IEEE 488 driver so that the data can be transferred using DMA (Direct Memory Access). The *Read Buffered Data* (**R**) command **R2** instructs the MultiScan/1200 to supply the oldest *Trigger Block* of data that is currently available.
- **Lines 51-52:** At the completion of the DMA transfer, the integer data is now in the buffer **BUFFER%**. To convert the integer data into temperatures and into voltages, simple calculations are performed.

Acquiring HLL Data in Binary Format

TempScan/1100

Example 15o. BIN_HLL.BAS Program

```
(1)   CLS : PRINT "The TempScan/1100 is resetting..."
      PRINT #1, "OUTPUT 07;*RX"
(3)   SLEEP 10
(4)   S% = 0
      WHILE (S% AND 4) = 0
          PRINT #1, "SPOLL 07"
          INPUT #2, S%
(8)   WEND
(9)   PRINT #1, "OUTPUT 07;C1-32,1X"
(10)  PRINT #1, "OUTPUT 07;C33-48,14X"
(11-29) (For sample acquisition program lines, refer to the previous TempScan/1100 program example.)
(30)  PRINT #1, "OUTPUT 07;F0,1X"
(31)  CONST CHANNELS% = 48, BYTES = CHANNELS% * 20
      DIM READS AS STRING * BYTES
      S% = VARSEG(READS)
      O% = VARPTR(READS)
      WHILE INKEY$ = ""
          PRINT #1, "OUTPUT 07;U4X"
          PRINT #1, "ENTER 07 #"; CHANNELS%*20; "BUFFER ";S%; ":";O%; " DMA"
(38)  PRINT "High, Low and Last readings of all 48 channels : "
(39)  FOR i = 1 TO BYTES STEP 20
          HIGH$ = STR$(CVI(MID$(READS, i, 2)))
(41)  HOURh$ = STR$(ASC(MID$(READS, i + 2, 1)))
          MINh$ = STR$(ASC(MID$(READS, i + 3, 1)))
          SECh$ = STR$(ASC(MID$(READS, i + 4, 1)))
          TENTHh$ = STR$(ASC(MID$(READS, i + 5, 1)))
          MONh$ = STR$(ASC(MID$(READS, i + 6, 1)))
          DAYh$ = STR$(ASC(MID$(READS, i + 7, 1)))
          YEARh$ = STR$(ASC(MID$(READS, i + 8, 1)))
(48)  LOW$ = STR$(CVI(MID$(READS, i + 9, 2)))
(49)  HOURl$ = STR$(ASC(MID$(READS, i + 11, 1)))
          MINl$ = STR$(ASC(MID$(READS, i + 12, 1)))
          SECl$ = STR$(ASC(MID$(READS, i + 13, 1)))
          TENTHl$ = STR$(ASC(MID$(READS, i + 14, 1)))
          MONl$ = STR$(ASC(MID$(READS, i + 15, 1)))
          DAYl$ = STR$(ASC(MID$(READS, i + 16, 1)))
          YEARl$ = STR$(ASC(MID$(READS, i + 17, 1)))
(56)  LAST$ = STR$(CVI(MID$(READS, i + 18, 2)))
          PRINT HIGH$+HOURh$+MINh$+SECh$+TENTHh$+MONh$+DAYh$+YEARh$
          PRINT LOW$+HOURl$+MINl$+SECl$+TENTHl$+MONl$+DAYl$+YEARl$
(59)  NEXT i
(60)  BINARY DATA%/10 = °C
(61)  BINARY DATA%/3276.7 = V (±10 V DC)
```

The following program is **BIN_HLL.BAS** in the **\EXAMPLES** subdirectory. It will configure 32 thermocouple and 16 volts channels, set up the TempScan/1100 for acquisition, and then after the acquisition is complete, collect the High/Last/Low (HLL) channel readings in a Binary format rather than the default ASCII format. The Binary format is inherently faster than ASCII format, but the data must be deciphered after it is collected in order to yield the temperature values.

- **Lines 1-3:** Although not necessary, it is good practice to reset the TempScan/1100 at the start of your application by sending the *Reset Power-On* (***R**) command. Wait a few seconds.
- **Lines 4-8:** To be certain that the reset was successful and the device is ready, Serial Poll the device until the proper status is returned.
- **Lines 9-10:** The *Configure Channels* (**C**) command will be used once to configure a range of channels from 1 to 32 as Type J thermocouples, and used again to configure a range of channels from 33 to 48 as 10-Volt DC inputs.
- **Lines 11-29:** For sample acquisition program lines, refer to the previous TempScan/1100 program example. For convenience, lines 11-29 from that example are identical to lines 11-29 in this example.
- **Line 30:** Before reading the data, the *Set Data Format* (**F**) command is sent, instructing the TempScan/1100 to return the data in Binary format where every value will be 2 bytes in length. This command can be issued anytime after the initial reset, and stays in effect until the unit is reset again or another **F** command is issued.
- **Lines 31-38:** This example will now use DMA (Direct Memory Access) to transfer the HLL data into the controller. For this purpose, an array is dimensioned, then the offset and segment pointers are supplied to the IEEE 488 driver. After the **ENTER** command has completed, the Binary data will be in the string **READS**.
- **Lines 39-59:** To convert the data into integer form, the string must be parsed and decoded.
- **Lines 60-61:** To convert the integer data into temperatures and into voltages, simple calculations are performed.

MultiScan/1200

Example 15p. BIN_HLL.BAS Program

```
(1)   CLS : PRINT "The MultiScan/1200 is resetting..."
      PRINT #1, "OUTPUT 07;*RX"
(3)   SLEEP 10
(4)   S% = 0
      WHILE (S% AND 4) = 0
          PRINT #1, "SPOLL 07"
          INPUT #2, S%
(8)   WEND
(9)   PRINT #1, "OUTPUT 07;M#0X"
(10)  PRINT #1, "OUTPUT 07;W#32X"
(11)  PRINT #1, "OUTPUT 07;C1-24,1X"
(12)  PRINT #1, "OUTPUT 07;C25-36,14X"
(13-31) (For sample acquisition program lines, refer to the previous MultiScan/1200 program example.)
(32)  PRINT #1, "OUTPUT 07;F0,1X"
(33)  CONST CHANNELS% = 36, BYTES = CHANNELS% * 20
      DIM READS AS STRING * BYTES
      S% = VARSEG(READS)
      O% = VARPTR(READS)
      WHILE INKEY$ = ""
          PRINT #1, "OUTPUT 07;U4X"
          PRINT #1, "ENTER 07 #"; CHANNELS%*20; "BUFFER ";S%; ":";O%; " DMA"
(40)  PRINT "High, Low and Last readings of all 36 channels : "
(41)  FOR i = 1 TO BYTES STEP 20
          HIGH$ = STR$(CVI(MID$(READS, i, 2)))
(43)  HOURh$ = STR$(ASC(MID$(READS, i + 2, 1)))
          MINh$ = STR$(ASC(MID$(READS, i + 3, 1)))
          SECh$ = STR$(ASC(MID$(READS, i + 4, 1)))
          TENTHh$ = STR$(ASC(MID$(READS, i + 5, 1)))
          MONh$ = STR$(ASC(MID$(READS, i + 6, 1)))
          DAYh$ = STR$(ASC(MID$(READS, i + 7, 1)))
          YEARh$ = STR$(ASC(MID$(READS, i + 8, 1)))
(50)  LOW$ = STR$(CVI(MID$(READS, i + 9, 2)))
(51)  HOURl$ = STR$(ASC(MID$(READS, i + 11, 1)))
          MINl$ = STR$(ASC(MID$(READS, i + 12, 1)))
          SECl$ = STR$(ASC(MID$(READS, i + 13, 1)))
          TENTHl$ = STR$(ASC(MID$(READS, i + 14, 1)))
          MONl$ = STR$(ASC(MID$(READS, i + 15, 1)))
          DAYl$ = STR$(ASC(MID$(READS, i + 16, 1)))
          YEARl$ = STR$(ASC(MID$(READS, i + 17, 1)))
(58)  LAST$ = STR$(CVI(MID$(READS, i + 18, 2)))
          PRINT HIGH$+HOURh$+MINh$+SECh$+TENTHh$+MONh$+DAYh$+YEARh$
          PRINT LOW$+HOURl$+MINl$+SECl$+TENTHl$+MONl$+DAYl$+YEARl$
(61)  NEXT i
(62)  BINARY DATA%/10 = °C
(63)  BINARY DATA%/3276.7 = V (±10 V DC)
```

The following program is **BIN_HLL.BAS** in the **\EXAMPLES** subdirectory. It will configure 24 thermocouple and 12 volts channels, set up the MultiScan/1200 for acquisition, and then after the acquisition is complete, collect the High/Last/Low (HLL) channel readings in a Binary format rather than the default ASCII format. The Binary format is inherently faster than ASCII format, but the data must be deciphered after it is collected in order to yield the temperature values.

- **Lines 1-3:** Although not necessary, it is good practice to reset the MultiScan/1200 at the start of your application by sending the *Reset Power-On* (***R**) command. Wait a few seconds.
- **Lines 4-8:** To be certain that the reset was successful and the device is ready, Serial Poll the device until the proper status is returned.
- **Lines 9-10:** The first thing necessary to start scanning is to setup the measuring mode. In this case, the MultiScan/1200 will be setup for line-cycle integration / high-speed multi-channel mode.
- **Lines 11-12:** The *Configure Channels* (**C**) command will be used once to configure a range of channels from 1 to 24 as Type J thermocouples, and used again to configure a range of channels from 25 to 36 as 10-Volt DC inputs.
- **Lines 13-31:** For sample acquisition program lines, refer to the previous MultiScan/1200 program example. For convenience, lines 13-31 from that example are identical to lines 13-31 in this example.
- **Line 32:** Before reading the data, the *Set Data Format* (**F**) command is sent, instructing the MultiScan/1200 to return the data in Binary format where every value will be 2 bytes in length. This command can be issued anytime after the initial reset, and stays in effect until the unit is reset again or another **F** command is issued.
- **Lines 33-40:** This example will now use DMA (Direct Memory Access) to transfer the HLL data into the controller. For this purpose, an array is dimensioned, then the offset and segment pointers are supplied to the IEEE 488 driver. After the **ENTER** command has completed, the Binary data will be in the string **READS**.
- **Lines 41-61:** To convert the data into integer form, the string must be parsed and decoded.
- **Lines 62-63:** To convert the integer data into temperatures and into voltages, simple calculations are performed.

Using Auto Re-arm to Capture Multiple Trigger Blocks

TempScan/1100

Example 15q. BLK_ACQ.BAS Program

```
(1)   CLS : PRINT "The TempScan/1100 is resetting..."
      PRINT #1, "OUTPUT 07;*RX"
(3)   SLEEP 10
(4)   S% = 0
      WHILE (S% AND 4) = 0
          PRINT #1, "SPOLL 07"
          INPUT #2, S%
(8)   WEND
(9)   PRINT #1, "OUTPUT 07;C1-16,1X"
(10)  PRINT #1, "OUTPUT 07;C33-48,2X"
(11)  PRINT #1, "OUTPUT 07;Y1000,20,10X"
(12)  PRINT #1, "OUTPUT 07;I00:00:00.3,00:00:00.0X"
(13)  PRINT #1, "OUTPUT 07;T1,8,1,0X"
(14)  PRINT #1, "OUTPUT 07;Q0,0,8,8,0X"
(15)  FOR i = 1 TO 5
      PRINT "The TempScan/1100 is collecting Pre-Trigger data for
            Trigger Block "; i; " and has not been triggered..."
      PRINT "Hit a key to trigger the start of acquisition..."
      WHILE INKEY$ = "": WEND
(19)  PRINT #1, "OUTPUT 07;@X"
(20)  PRINT "Waiting for Trigger Block "; i; " to complete..."
      B% = 0
(22)  WHILE B% <> 1
          PRINT #1, "OUTPUT 07; U6X"
          PRINT #1, "ENTER 07"
          LINE INPUT #2, U$
          UA$ = MID$(U$, 86, 2)
          B% = VAL(UA$)
      WEND
(29)  PRINT "Trigger Block "; i; " has completed and the
            TempScan/1100 has re-armed itself..."
(30)  UAT$ = MID$(U$, 9, 7)
      PRINT UAT$
      PRINT "The TempScan/1100 has collected a total of "; VAL(UAT$);
            " scans."
(33)  UA$ = MID$(U$, 18, 7)
      PRINT UA$
      PRINT "Pre-Trigger scans: "; VAL(UA$)
      UA$ = MID$(U$, 47, 8)
      PRINT "Post-Trigger scans: "; VAL(UA$)
      UAS$ = MID$(U$, 77, 8)
      PRINT "Post-Stop scans: "; VAL(UAS$) - VAL(UA$)
(40)  PRINT "Uploading Trigger Block"; i; " ..."
      PRINT #1, "OUTPUT 07;R2X"
      FOR c = 1 TO VAL(UAT$)
          PRINT #1, "ENTER 07"
          LINE INPUT #2, SCAN$
      NEXT c
      PRINT "Trigger Block "; i; " is read."
(47)  NEXT i
(48)  PRINT #1, "OUTPUT 07;T0,0,0,0X"
```

The following program is **BLK_ACQ.BAS** in the **\EXAMPLES** subdirectory. It will configure 32 thermocouple channels, and will set up the TempScan/1100 unit for *Auto Re-arm*, which re-arms the unit for another *Trigger* (trigger start event) as soon as the current acquisition has been completed.

- **Lines 1-3:** Although not necessary, it is good practice to reset the TempScan/1100 at the start of your application by sending the *Reset Power-On* (***R**) command. Wait a few seconds.
- **Lines 4-8:** To be certain that the reset was successful and the device is ready, Serial Poll the device until the proper status is returned.
- **Lines 9-10:** The *Configure Channels* (**C**) command will be used once to configure a range of channels from 1 to 16 as Type J thermocouples, and used again to configure a range of channels from 33 to 48 as Type K thermocouples.
- **Line 11:** The *Set Counts* (**X**) command is used to configure the number of scans to take while in the different acquisition states. In this example, 1000 scans will be taken while in the *Pre-Trigger* state, 20 while in the *Post-Trigger* state, and 10 while in the *Post-Stop* state. The *Post-Trigger* count is only valid when the *Stop* (trigger stop event) is set to Count via the *Set Trigger Configuration* (**T**) command. This example will in fact use Count, so this parameter is valid.
- **Line 12:** The *Set Scan Interval* (**I**) command sets the time period between scans in hours-minutes-seconds format. The TempScan/1100 can have two different scan intervals, one for the *Post-Trigger* state (acquisition scan interval), and one for the *Pre-Trigger* and *Post-Stop* states (normal scan interval). This example sets up the *Pre-Trigger* and *Post-Stop* scan intervals to 0.3 seconds (3.0 Hz), and sets up the *Post-Trigger* scan interval to 0.0 second, which defaults the TempScan/1100 acquisition to fast mode.
- **Line 13:** The *Set Trigger Configuration* (**T**) command sets up the *Trigger* (trigger start event) and *Stop* (trigger stop event) parameters for the acquisition. In this example, the *Trigger* is assigned the *Trigger On* (**@**) command character as sent by the controller, while the *Stop* is assigned to Count.

In this example, the *Auto Re-arm* flag is enabled so that the TempScan/1100 will automatically re-arm itself for another acquisition after the current acquisition is complete. Meanwhile, the synchronization flag are disabled so that the TempScan/1100 will not re-synchronize itself to the *Trigger* point when the *Trigger* (trigger start event) begins. When the TempScan/1100 encounters the *Execute* (**X**) command, it will be armed and will start the collection of the *Pre-Trigger* data.

- **Line 14:** The *Set Query Terminator* (**Q**) command is used to set the buffer terminators for the data that is transferred to the controller. Both the scan terminator and *Trigger Block* terminator are set to **LF** (line feed).
- **Lines 15-19:** The **FOR** loop will read five *Trigger Blocks*, each consisting of one *Trigger* point. These first lines of code within the loop will ask you to trigger the TempScan/1100 unit.
- **Lines 20-39:** During the acquisition or after the acquisition has been completed, the Acquisition Buffer can be queried for the data that is available for transfer. These next lines of code within the loop use the *User Status* (**U**) command **U6** to query the Buffer Status String, as described in previous examples. This example uses the last parameter in the return string as an indicator of how much data is available to transfer to the IEEE 488 controller. The function **MID\$** is used to extract characters from the string **U\$**.
- **Lines 40-47:** After using the **U\$** string to calculate the number of scans available in the buffer, the last lines of code within the loop use the *Read Buffered Data* (**R**) command **R2** to instruct the TempScan/1100 unit to supply the oldest complete *Trigger Block* of data that is currently available. Then the **NEXT** command will return the unit to the start of the loop.
- **Line 48:** After five loops and all five *Trigger Blocks* have been collected, the TempScan/1100 unit is disarmed by sending the *Set Trigger Configuration* (**T**) command.

MultiScan/1200

Example 15r. BLK_ACQ.BAS Program

```
(1)   CLS : PRINT "The MultiScan/1200 is resetting..."
      PRINT #1, "OUTPUT 07;*RX"
(3)   SLEEP 10
(4)   S% = 0
      WHILE (S% AND 4) = 0
          PRINT #1, "SPOLL 07"
          INPUT #2, S%
(8)   WEND
(9)   PRINT #1, "OUTPUT 07;M#0X"
(10)  PRINT #1, "OUTPUT 07;W#32X"
(11)  PRINT #1, "OUTPUT 07;C1-12,1X"
(12)  PRINT #1, "OUTPUT 07;C25-36,2X"
(13)  PRINT #1, "OUTPUT 07;Y1000,20,10X"
(14)  PRINT #1, "OUTPUT 07;I00:00:00.3,00:00:00.0X"
(15)  PRINT #1, "OUTPUT 07;T1,8,1,0X"
(16)  PRINT #1, "OUTPUT 07;Q0,0,8,8,0X"
(17)  FOR i = 1 TO 5
      PRINT "The MultiScan/1200 is collecting Pre-Trigger data for
            Trigger Block "; i; " and has not been triggered..."
      PRINT "Hit a key to trigger the start of acquisition..."
      WHILE INKEY$ = "": WEND
(21)  PRINT #1, "OUTPUT 07;@X"
(22)  PRINT "Waiting for Trigger Block "; i; " to complete..."
      B% = 0
(24)  WHILE B% <> 1
          PRINT #1, "OUTPUT 07; U6X"
          PRINT #1, "ENTER 07"
          LINE INPUT #2, U$
          UA$ = MID$(U$, 86, 2)
          B% = VAL(UA$)
      WEND
(31)  PRINT "Trigger Block "; i; " has completed and the
            MultiScan/1200 has re-armed itself..."
(32)  UAT$ = MID$(U$, 9, 7)
      PRINT UAT$
      PRINT "The MultiScan/1200 has collected a total of ";
            VAL(UAT$); " scans."
(35)  UA$ = MID$(U$, 18, 7)
      PRINT UA$
      PRINT "Pre-Trigger scans: "; VAL(UA$)
      UA$ = MID$(U$, 47, 8)
      PRINT "Post-Trigger scans: "; VAL(UA$)
      UAS$ = MID$(U$, 77, 8)
      PRINT "Post-Stop scans: "; VAL(UAS$) - VAL(UA$)
(42)  PRINT "Uploading Trigger Block"; i; " ..."
      PRINT #1, "OUTPUT 07;R2X"
      FOR c = 1 TO VAL(UAT$)
          PRINT #1, "ENTER 07"
          LINE INPUT #2, SCAN$
      NEXT c
      PRINT "Trigger Block "; i; " is read."
(49)  NEXT i
(50)  PRINT #1, "OUTPUT 07;T0,0,0,0X"
```

The following program is **BLK_ACQ.BAS** in the **\EXAMPLES** subdirectory. It will configure 24 thermocouple channels, and will set up the MultiScan/1200 unit for *Auto Re-arm*, which re-arms the unit for another *Trigger* (trigger start event) as soon as the current acquisition has been completed.

- **Lines 1-3:** Although not necessary, it is good practice to reset the MultiScan/1200 at the start of your application by sending the *Reset Power-On* (***R**) command. Wait a few seconds.
- **Lines 4-8:** To be certain that the reset was successful and the device is ready, Serial Poll the device until the proper status is returned.
- **Lines 9-10:** The first thing necessary to start scanning is to setup the measuring mode. In this case, the MultiScan/1200 will be setup for line-cycle integration / high-speed multi-channel mode.
- **Lines 11-12:** The *Configure Channels* (**C**) command will be used once to configure a range of channels from 1 to 12 as Type J thermocouples, and used again to configure a range of channels from 25 to 36 as Type K thermocouples.
- **Line 13:** The *Set Counts* (**X**) command is used to configure the number of scans to take while in the different acquisition states. In this example, 1000 scans will be taken while in the *Pre-Trigger* state, 20 while in the *Post-Trigger* state, and 10 while in the *Post-Stop* state. The *Post-Trigger* count is only valid when the *Stop* (trigger stop event) is set to Count via the *Set Trigger Configuration* (**T**) command. This example will in fact use Count, so this parameter is valid.
- **Line 14:** The *Set Scan Interval* (**I**) command sets the time period between scans in hours-minutes-seconds format. The MultiScan/1200 can have two different scan intervals, one for the *Post-Trigger* state (acquisition scan interval), and one for the *Pre-Trigger* and *Post-Stop* states (normal scan interval). This example sets up the *Pre-Trigger* and *Post-Stop* scan intervals to 0.3 seconds (3.0 Hz), and sets up the *Post-Trigger* scan interval to 0.0 second, which defaults the MultiScan/1200 acquisition to fast mode.
- **Line 15:** The *Set Trigger Configuration* (**T**) command sets up the *Trigger* (trigger start event) and *Stop* (trigger stop event) parameters for the acquisition. In this example, the *Trigger* is assigned the *Trigger On* (**@**) command character as sent by the controller, while the *Stop* is assigned to Count.

In this example, the *Auto Re-arm* flag is enabled so that the MultiScan/1200 will automatically re-arm itself for another acquisition after the current acquisition is complete. Meanwhile, the synchronization flag are disabled so that the MultiScan/1200 will not re-synchronize itself to the *Trigger* point when the *Trigger* (trigger start event) begins. When the MultiScan/1200 encounters the *Execute* (**X**) command, it will be armed and will start the collection of the *Pre-Trigger* data.

- **Line 16:** The *Set Query Terminator* (**Q**) command is used to set the buffer terminators for the data that is transferred to the controller. Both the scan terminator and *Trigger Block* terminator are set to **LF** (line feed).
- **Lines 17-21:** The **FOR** loop will read five *Trigger Blocks*, each consisting of one *Trigger* point. These first lines of code within the loop will ask you to trigger the MultiScan/1200 unit.
- **Lines 22-41:** During the acquisition or after the acquisition has been completed, the Acquisition Buffer can be queried for the data that is available for transfer. These next lines of code within the loop use the *User Status* (**U**) command **U6** to query the Buffer Status String, as described in previous examples. This example uses the last parameter in the return string as an indicator of how much data is available to transfer to the IEEE 488 controller. The function **MID\$** is used to extract characters from the string **U\$**.
- **Lines 42-49:** After using the **U\$** string to calculate the number of scans available in the buffer, the last lines of code within the loop use the *Read Buffered Data* (**R**) command **R2** to instruct the MultiScan/1200 unit to supply the oldest complete *Trigger Block* of data that is currently available. Then the **NEXT** command will return the unit to the start of the loop.
- **Line 50:** After five loops and all five *Trigger Blocks* have been collected, the MultiScan/1200 unit is disarmed by sending the *Set Trigger Configuration* (**T**) command.

Acquiring Burst Mode Data (MultiScan/1200 Only)

Example 15s. BURST.BAS Program

```
(1)   CLS : PRINT "The MultiScan/1200 is resetting..."
      PRINT #1, "OUTPUT 07;*RX"
(3)   SLEEP 10
(4)   S% = 0
      WHILE (S% AND 4) = 0
          PRINT #1, "SPOLL 07"
          INPUT #2, S%
(8)   WEND
(9)   PRINT #1, "OUTPUT 07;M#1X"
(10)  PRINT #1, "OUTPUT 07;F#20000.0X"
(11)  PRINT #1, "OUTPUT 07;C1,14X"
(12)  SLEEP 1
(13)  PRINT #1, "OUTPUT 07;Y0,8,0X"
(14)  PRINT #1, "OUTPUT 07;T1,8,0,0X"
(15)  PRINT "Hit a key to trigger the burst-mode acquisition..."
      WHILE INKEY$ = "": WEND
      PRINT #1, "OUTPUT 07;@X"
(18)  WHILE (S% AND 2) <> 2
          PRINT #1,"SPOLL 07"
          INPUT #2, S%
      WEND
      PRINT "The Trigger has been detected..."
(23)  PRINT "Waiting for the acquisition to complete..."
(24)  WHILE (E% AND 1) <> 1
          PRINT #1,"OUTPUT 07;U0X"
          PRINT #1,"ENTER 07"
          INPUT #2, E%
      WEND
(29)  PRINT "The acquisition is now complete..."
(30)  PRINT #1, "OUTPUT 07;U6X"
      PRINT #1, "ENTER 07"
      LINE INPUT #2, U$
      PRINT U$
      UA$ = MID$(U$, 8, 6)
      UA% = VAL(UA$)
      PRINT UA%
(37)  PRINT #1, "The MultiScan/1200 collected"; UA%; "scans of data."
(38)  FOR i = 1 TO UA%
          PRINT #1, "OUTPUT 07;R1X"
          PRINT #1, "ENTER 14"
          INPUT #2, SCAN$
          PRINT "Scan "; i; " is :"
          PRINT SCAN$
(44)  NEXT I
```

The following program is **BURST.BAS** in the **\EXAMPLES** subdirectory. It will set up the MultiScan/1200 for an acquisition in single-channel high-speed burst mode and then bring the values into the controller after the acquisition is complete.

- **Lines 1-3:** Although not necessary, it is good practice to reset the MultiScan/1200 at the start of your application by sending the *Reset Power-On* (***R**) command. Wait a few seconds.
- **Lines 4-8:** To be certain that the reset was successful and the device is ready, Serial Poll the device until the proper status is returned.
- **Lines 9-10:** The first thing necessary to start scanning is to setup the measuring mode. In this case, the MultiScan/1200 will be setup for single-channel high-speed burst mode, and for a sampling frequency of 20 kHz.
- **Lines 11-12:** The *Configure Channels* (**C**) command will be used once to configure Channel 1 as a 10-Volt DC input. Insert a brief pause.
- **Line 13:** Using the *Set Counts* (**Y**) command, program the burst-mode acquisition for 8 blocks of 256 scans. Note that the *Trigger* (trigger start event) can only be assigned with the software *Trigger On* (**@**) command while the *Stop* (trigger stop event) can only be assigned with *Count*.
- **Line 14:** Using the *Set Trigger Configuration* (**T**) command, the *Trigger* (trigger start event) is assigned the *Trigger On* (**@**) command character as sent by the controller, while the *Stop* (trigger stop event) is assigned to *Count*. Both the *Auto Re-arm* flag and the synchronization flag are disabled, as described in previous examples. When the MultiScan/1200 encounters the *Execute* (**X**) command, it will be armed and will start the collection of the data.
- **Lines 15-23:** After the last *Execute* (**X**) command has been received, the MultiScan/1200 arms itself and then waits for the *Trigger* (trigger start event). The IEEE 488 Serial Poll (**SPOLL**) command is used to query the acquisition status of the MultiScan/1200. A **SPOLL** value of 2 signifies that the MultiScan/1200 has detected the *Trigger*.
- **Lines 24-29:** Using the *User Status* (**U**) command **U0** to query the Event Status Register (**ESR**), we now wait until the Acquisition Complete event is reached. After the acquisition is complete, the single-channel burst-mode data can now be retrieved using the standard retrieval commands keeping in mind that the acquisition will look like 8 blocks of 256 channels.
- **Lines 30-37:** During the acquisition or after the acquisition has been completed, the Acquisition Buffer can be queried for the data that is available for transfer. The *User Status* (**U**) command **U6** can be used to query the Buffer Status String, which includes the following eight fields of information: (1) Number of Trigger Blocks Available, (2) Number of Scans Available, (3) Current Position of Read Pointer, (4) Time/Date Stamping of Trigger Event, (5) Position of Stop Event Pointer, (6) Time/Date Stamping of Stop Event, (7) Position of End Scan Pointer, and (8) Status of Current Trigger Block. For more information on the Acquisition Buffer, see chapter *System Operation*.

This example uses the last parameter in the return string as an indicator of how much data is available to transfer to the IEEE 488 controller. The function **MID\$** extracts 6 characters from the string **U\$** starting at character 8.
- **Lines 38-44:** The *Read Buffered Data* (**R**) command **R1** is used to request the oldest scan from the unit. Using the variable **UA%** calculated from the previous step, all of the oldest scan data is transferred to the controller.

Introduction	276
Command Syntax.....	276
Command Interpretation.....	277
Command Summary.....	280
Command Reference	285
Command Description Format.....	285
The Commands.....	285
@ - Trigger On Command.....	286
*B - Flush Acquisition Buffer.....	287
*C - Clear Channel Configuration.....	288
*F - Restore Factory Settings.....	289
*G - Set RTD Gain Calibration Reference.....	290
*K - Change Calibration Keyword.....	291
*P - Adjust Calibration Card Pots.....	292
*R - Reset Power-On.....	293
*S - Set Power-Up Configuration.....	294
*T - Set Scan Time Stamping.....	295
*W - Set Software Digital Filtering.....	296
A - Assign Alarm Output.....	297
A# - Set Scan Alarm Stamping.....	298
C - Configure Channels.....	299
C# - Select Cards.....	302
D# - Set Relay Make Time.....	303
E - End Calibration Mode.....	304
E? - Query Error Status.....	305
F - Set Data Format.....	306
F# - Set Burst Mode Frequency.....	308
G - Calibrate Channel Gain.....	309
H - Calibrate Channel Offset.....	310
I - Set Scan Interval.....	311
I# - Set Digital Input Stamping.....	312
J - Calibrate Cold Junction Offset.....	313
K - Enter Calibration Mode.....	314
L - Set Trigger Level.....	315
L# - Set Scan Rate.....	316
M - Set SRQ Mask.....	317
M# - Set Measuring Mode.....	318
N - Set Event Mask.....	319
O - Set Digital Output.....	320
P - Program Trigger Times.....	321
Q - Set Query Terminator.....	322
QC? - Query Card Data.....	323
R - Read Buffered Data.....	324
R# - Read Last Readings.....	325
S - Set Real-Time Clocks.....	326
T - Set Trigger Configuration.....	327
U - User Status.....	329
V - Set User Terminator.....	332
W# - Set Averaging Weight.....	333
X - Execute.....	334
Y - Set Counts.....	335
? - Query.....	336

Introduction

Command Syntax

Command Characters

Commands are identified with the following characters:

- A single letter (**A** through **Z**)
- A single letter (**A** through **Z**) followed by a pound sign (**#**)
- An at-sign character (**@**)
- An asterisk (*****) followed by a single letter (**A** through **Z**)

In addition, the commands are governed by the following syntax rules.

Case Sensitivity

Commands may be entered in upper or lower case.

For example, **A1,1X** is interpreted the same as **a1,1x**.

White Spaces

White space (which consists of all ASCII values of 32 and below, and includes the space, tab, new-line and carriage-return characters) is generally allowed anywhere between commands and command arguments. However, white space is *not* allowed in the middle of command options.

For example, **1 2 3** is *not* the same as **123**.

Multiple Parameters

If more than one parameter is used for a command, they *must* be separated by a comma or white space.

For example: **Q4,1,1,0,0X** or **Q 4 1 1 0 0X** is appropriate.

Command Strings

Commands may be sent individually or in a string with other commands.

For example, the following four lines of a program:

```
PRINT#1, "OUTPUT07;C1,1X"  
PRINT#1, "OUTPUT07;A1,1X"  
PRINT#1, "OUTPUT07;C2,2X"  
PRINT#1, "OUTPUT07;A2,2X"
```

have the same effect as the single line:

```
PRINT#1, "OUTPUT07; C1,1 A1,1 C2,2 A2,2 X"
```

Execute Command

Deferred commands are interpreted and processed in the Acquisition Buffer as they are received, but they require the *Execute (X)* command to be issued in order to be executed. If multiple system commands are used in the same string, each use of the command must be followed by the *Execute (X)* command. Any number of *Execute (X)* commands may be inserted into the same command string. However, immediate commands do not require an *Execute (X)* command to be processed. For more detail on these command types, see section *Command Interpretation* next in this chapter.

For example, to clear the SRQ Mask and then set it for SRQ on Trigger Event:

```
PRINT#1, OUTPUT10; "M000 X M002 X"
```

To configure Channels 1 through 32 for temperature and Channels 33 through 64 for volts, using one command string:

```
PRINT#1, "OUTPUT07;C1-32,1 C33-64,11 X"
```

Fixed Formats

Any command with the *Query* (?) command extension or any *User Status* (U) command returns a fixed format. For instance, any option that can range up to 65,535 always returns five digits, so zero would be returned as 00000. In the following command descriptions, leading zeros are included. However, they are not required when entering the command.

Conflict Errors

Some combinations of commands and parameters can be sent to the TempScan/1100 or MultiScan/1200 unit that are out of range for a particular configuration or inconsistent with other commands. For instance, specifying a *Set Scan Interval* (I) command with less time than the unit can acquire scans results in a conflict error:

```
PRINT#1,"OUTPUT07;C1-992,I00:00:00.0,00:00:00.0X"
```

A conflict error lights up the *ERROR* LED indicator on the TempScan/1100 or MultiScan/1200 front panel and returns an **E4** when queried with the *Query Error Status* (E?) command. Some conflict errors result in a default value for a conflicted command. For instance, in the example above, the specified *Set Scan Interval* (I) command defaults to the fastest possible scan interval for the number of defined channels.

Command Interpretation

As commands are received by the unit, they are interpreted in the order in which they are received. Some commands are *immediate*, which means they immediately take effect. Other commands are *deferred* and have no effect on device operation until the *Execute* (X) command is interpreted.

Immediate & Deferred Commands

An example of an immediate command is the *Set Digital Outputs* (O) command, which immediately chooses the specified digital output line. An example of a deferred command is the *Set Data Format* (F) command, which determines the input and output format used for channel data when the *Execute* (X) command is interpreted.

As deferred commands are interpreted, their desired effects are recorded in internal temporary registers. As additional deferred commands are interpreted, their effects are added to these registers, possibly overwriting earlier effects. Finally, when the *Execute* (X) command is interpreted, the temporary registers are examined in the execution order described later. If two deferred commands that do not affect the same function are received before the *Execute* (X) command, they take effect in the execution order. If a deferred command is sent multiple times within a command line, the last occurrence of the command will take precedence. Note that a command line is terminated by the *Execute* (X) command. For example, if the *Set Data Format* (F) command line **F1,1 F1,3X** is sent, the data output format will be as specified by the latter **F1,3X** command. The former **F1,1** command is overridden and never takes effect.

If an error is detected during command processing, commands are ignored up through and including the next *Execute* (X) command. Thus, any immediate commands after the error, and all deferred commands on the same line, are ignored. For example, the command line:

```
T1,1,0,0 O216,0,25,255 AA T3,7,0,0 K20 X
```

contains the error **AA**. Only the *Set Digital Outputs* (O) command **O216,0,25,255** is executed, because it is an immediate command that occurred before the error. The deferred commands **T1,1,0,0** and **T3,7,0,0** and the immediate command **K20** after the error have no effect.

Deferred commands help reduce the effects of errors and improve synchronization of command execution. The primary advantage of deferred commands is that they are executed as a group, either all or none. If any errors occur, deferred commands have no effect and the device is left in a consistent state instead of a partially modified, inconsistent state.

Table 16a. Immediate & Deferred Commands

Command		TempScan/1100	MultiScan/1200
@	Trigger On Command	Deferred	Deferred
*B	Flush Acquisition Buffer	Immediate	Immediate
*C	Clear Channel Configuration	Deferred	Deferred
*F	Restore Factory Settings	Immediate	Immediate
*G	Set RTD Gain Calibration Reference	Immediate	(N/A)
*K	Change Calibration Keyword	Immediate	Immediate
*P	Adjust Calibration Card Pots	Immediate	Immediate
*R	Reset Power-On	Immediate	Immediate
*S	Set Power-Up Configuration	Immediate	Immediate
*T	Set Scan Time Stamping	Immediate	Immediate
*W	Set Software Digital Filtering	Deferred	(N/A)
A	Assign Alarm Output	Deferred	Deferred
A#	Set Scan Alarm Stamping	Deferred	Deferred
C	Configure Channels	Deferred	Deferred
C#	Select Cards	Immediate	Immediate
D#	Set Relay Make Time	(N/A)	Deferred
E	End Calibration Mode	Immediate	Immediate
E?	Query Error Status	Immediate	Immediate
F	Set Data Format	Deferred	Deferred
F#	Set Burst Mode Frequency	(N/A)	Deferred
G	Calibrate Channel Gain	Immediate	Immediate
H	Calibrate Channel Offset	Immediate	Immediate
I	Set Scan Interval	Deferred	Deferred
I#	Set Digital Input Stamping	Deferred	Deferred
J	Calibrate Cold Junction Offset	Immediate	Immediate
K	Enter Calibration Mode	Immediate	Immediate
L	Set Trigger Level	Deferred	Deferred
L#	Set Scan Rate	Deferred	(N/A)
M	Set SRQ Mask	Deferred	Deferred
M#	Set Measuring Mode	(N/A)	Deferred
N	Set Event Mask	Deferred	Deferred
O	Set Digital Output	Immediate	Immediate
P	Program Trigger Times	Deferred	Deferred
Q	Set Query Terminator	Deferred	Deferred
QC?	Query Card Data	Immediate	Immediate
R	Read Buffered Data	Immediate	Immediate
R#	Read Last Readings	Immediate	Immediate
S	Set Real-Time Clocks	Immediate	Immediate
T	Set Trigger Configuration	Deferred	Deferred
U	User Status	Immediate	Immediate
V	Set User Terminator	Deferred	Deferred
W#	Set Averaging Weight	(N/A)	Deferred
X	Execute	Immediate	Immediate
Y	Set Counts	Deferred	Deferred
Command Extension		TempScan/1100	MultiScan/1200
?	Query	Immediate	Immediate

Table 16b. Deferred Commands Execution Order

Order	TempScan/1100		MultiScan/1200	
1	V	Set User Terminator	V	Set User Terminator
2	Q	Set Query Terminator	Q	Set Query Terminator
3	F	Set Data Format	F	Set Data Format
4	M	Set SRQ Mask	M	Set SRQ Mask
5	N	Set Event Mask	N	Set Event Mask
6	L	Set Trigger Level	L	Set Trigger Level
	Channel Setup Commands		Channel Setup Commands	
7	A	Assign Alarm Output	A	Assign Alarm Output
	A#	Set Scan Alarm Stamping	A#	Set Scan Alarm Stamping
	I#	Set Digital Input Stamping	I#	Set Digital Input Stamping
	*C	Clear Channel Configuration	*C	Clear Channel Configuration
	C	Configure Channels	C	Configure Channels
	*W	Set Software Digital Filtering	D#	Set Relay Make Time
	L#	Set Scan Rate	F#	Set Burst Mode Frequency
			M#	Set Measuring Mode
			W#	Set Averaging Weight
8	P	Program Trigger Times	P	Program Trigger Times
9	I	Set Scan Interval	I	Set Scan Interval
10	Y	Set Counts	Y	Set Counts
11	T	Set Trigger Configuration	T	Set Trigger Configuration
12	@	Trigger On Command	@	Trigger On Command

Deferred Commands Execution Order

The immediate commands take effect immediately when they are interpreted. Even so, they must be followed by an *Execute* (X) command to terminate the command string for correct operation. For example, the *Enter Calibration Mode* (K) command K00001X.

Deferred commands are not executed until the *Execute* (X) command has been successfully parsed and interpreted. Upon interpretation of the *Execute* (X) command, the order of execution of all deferred commands is as shown in the table.

This ordering ensures that the configuration of acquisitions takes place before any data is acquired. The *Set Trigger Configuration* (T) command is the last command performed before the issuance of any *Trigger* (trigger start event) since data acquisition may begin once the T command has been defined.

Command Summary

Command	Syntax	Description	
@	Trigger On Command	@	Trigger on receipt of an @.
*B	Flush Acquisition Buffer	*B	Flush any data currently in the Acquisition Buffer.
*C	Clear Channel Configuration	*C	Clear out the channel configuration so that no channels are configured.
*F	Restore Factory Settings	*F	Restore unit to factory configuration.
*G	Set RTD Gain Calibration Reference (TempScan/1100 only)	*Ggain	Set RTD Gain Calibration reference point to specified number of ohms. gain is the reference point in the form of a real number nnn.nn .
		G?	Query the present reference point setting.
*K	Change Calibration Keyword	*Kkey	Change the calibration keyword, where key is the keyword in the form of a 5-digit number nnnnn . Therefore the password can be no longer than 5 characters.
*P	Adjust Calibration Card Pots	*Pchan	Select voltage level to be enabled for adjustment. Valid options for chan are: 01 - Enable -4.4 Volt Source on calibration card, 02 - Enable +4.4. Volt Source on calibration card, and 03 - Select 0 Volts Ground.
*R	Reset Power-On	*R	Power-on reset. Equivalent to a hardware reset.
*S	Set Power-Up Configuration	*Smode	Specify power-up configuration mode. Valid options for mode are: 0 - Power-up under last known configuration (default), and 1 - Power-up under factory default configuration.
*T	Set Scan Time Stamping	*Tstate	Specify whether or not scan time stamping will be enabled. Valid options for state are: 0 - Disable scan time stamping (default), 1 - Enable absolute time stamping, and 2 - Enable relative time stamping
*W	Set Software Digital Filtering (TempScan/1100 only)	*Wmode	Specify whether or not software digital filtering for thermocouple cards will be enabled. Valid options for mode are: 0 - Disable digital filtering for thermocouple cards, and 1 - Enable digital filtering for thermocouple cards (default).
A	Assign Alarm Output	Achans, output	Set alarm condition where chans is the channel(s) to assign to the digital output. chans may be in two forms: chan (for a single channel where $1 \leq \text{chan} \leq \text{max}$) or first-last (for a range of channels where $1 \leq \text{first} < \text{last} \leq \text{max}$), where max = 992 for the TempScan/1100 and max = 744 for the MultiScan/1200. output is the digital output number to associate the channel(s) with, where $1 \leq \text{output} \leq 32$, and 0 is null.
		A?	Query channels assigned to digital output.
A#	Set Scan Alarm Stamping	A#state	Specify whether or not scan alarm stamping will be enabled. Valid options for state are: 0 - Disable scan alarm stamping (default), and 1 - Enable scan alarm stamping.
C	Configure Channels	Cchans, type [, [lowsp], [highsp], [hyst]]	Configure the channels for the master unit and its slave units. chans and type are required arguments, while lowsp , highsp and hyst are optional. chans may be in two forms: chan (for a single channel where $1 \leq \text{chan} \leq \text{max}$) or first-last (for a range of channels where $1 \leq \text{first} < \text{last} \leq \text{max}$), where max = 992 for the TempScan/1100 and max = 744 for the MultiScan/1200. The chassis is chan = 0 . type is the type to assign to those channels. 0 is null.
		C?	Query current channel configuration.

Command		Syntax	Description
C#	Select Card	C#card	Select the card from which subsequent QC? and U12 interrogation will retrieve information. Valid options for card are: 0 - Selects the chassis, 1 - Selects the card in the master unit, 2 - Selects the 1st slave card, 3 - Selects the 2nd slave card, 4 - Selects the 3rd slave card, etc, 30 - Selects the 29th slave card, and 31 - Selects the 30th slave card.
D#	Set Relay Make Time (MultiScan/1200 only)	D#make	Specify how long to wait after closing a channel relay before reading valid data, where make is the number of 520.833-microsecond intervals.
E	End Calibration Mode	E	Terminate <i>Calibration Mode</i>
E?	Query Error Status	E?	Returns present error condition of the unit with one of the following error codes: E128 - Command Conflict Error. E032 - Open Thermocouple or Range Error. E016 - Trigger Overrun. E008 - Calibration Error. E004 - Channel Configuration Error. E002 - Invalid Device Dependent Command Option (IDDCO). E001 - Invalid Device Dependent Command (IDDC). E000 - No error has occurred.
F	Set Data Format	Fengr , format	Configure the input and output formats. engr converts the raw data to the engineering units that you prefer to work with. Valid options are: 0 - degrees Celsius (default), 1 - degrees Fahrenheit, 2 - degrees Rankine, 3 - degrees Kelvin, and 4 - Volts. format places the readings in a format that you prefer to work with. Valid options are: 0 - Engineering Units (default), 1 - Binary (Low Byte/High Byte), 2 - Binary (High Byte/Low Byte), and 3 - Counts (ASCII).
		F?	Query the data format.
F#	Set Burst Mode Frequency (MultiScan/1200 only)	F#freq	Select burst mode sampling frequency where freq is a real number and where $38.5 \leq \text{freq} \leq 20000.0$ Hertz (default).
G	Calibrate Channel Gain	Gchan , type	Calibrate the correction gain constants for given option card where chan is the channel number such that $1 \leq \text{chan} \leq \text{max}$, where max = 992 for the TempScan/1100 and max = 744 for the MultiScan/1200. The chassis is chan = 0 . type is the channel type.
H	Calibrate Channel Offset	Hchan	Calibrate the correction offset constants for given option card where chan is the channel number such that $1 \leq \text{chan} \leq \text{max}$, where max = 992 for the TempScan/1100 and max = 744 for the MultiScan/1200. The chassis is chan = 0 .
I	Set Scan Interval	Inorm , acq	Set the two configurable scan intervals of the unit where norm and acq are the normal and acquisition scan intervals which have the form: hh:mm:ss.t where hh is hours, mm is minutes, ss is seconds, and t is tenths of a second.
		I?	Query scan interval selection.
I#	Set Digital Input Stamping	I#state	Specify whether or not digital input stamping will be enabled. Valid options for state are: 0 - Disable digital input stamping (default), and 1 - Enable digital input stamping.

Command	Syntax	Description
J	Calibrate Cold Junction Offset	Jchan, type, temp Calibrate the cold-junction offsets for cold-junction compensation of the thermocouple signals where chan is the channel number such that $1 \leq \text{chan} \leq \text{max}$, where max = 992 for the TempScan/1100 and max = 744 for the MultiScan/1200. type is the thermocouple channel type. temp is the reference temperature currently being applied to the selected channel, with the form nnn.n in degrees °C.
K	Enter Calibration Mode	Kkey Enter <i>Calibration Mode</i> if the keyword (or password) is correct, where key is the keyword in the form of a 5-digit number nnnnn . Therefore the password can be no longer than 5 characters.
		K? Query Kkey as defined above.
L	Set Trigger Level	Lchan, level, hyst Sets the level against which the testing of channel readings should be performed where chan is the channel number such that $1 \leq \text{chan} \leq \text{max}$, where max = 992 for the TempScan/1100 and max = 744 for the MultiScan/1200. level is the level against which the readings are tested to determine if the level has been exceeded. hyst is the hysteresis level.
		L? Query the current level settings
L#	Set Scan Rate (TempScan/1100 only)	L#rate Specify whether to select the optional slow scan rate or to select the default fast scan. Valid options for rate are: 0 - Select fast scan rate (default), and 1 - Select slow scan rate.
M	Set SRQ Mask	Mmask Use the IEEE 488 Service Request (SRQ) mechanism to inform the IEEE 488 bus controller of certain conditions, where mask is in the form of the number nnn such that $000 \leq \text{nnn} \leq 255$ is summed from the following conditions: 128 - SRQ on Buffer Overrun. 032 - SRQ on Event Detected. 016 - SRQ on Message Available (MAV). 008 - SRQ on Scan Available. 004 - SRQ on Ready. 002 - SRQ on Trigger Event. 001 - SRQ on Alarm. 000 - Clear SRQ Mask.
		M? Query the SRQ mask.
M#	Set Measuring Mode (MultiScan/1200 only)	M#mode Specify measuring mode. Valid options for mode are: 0 - Line-cycle integration / high-speed multi-channel mode, and 1 - Single-channel high-speed burst mode.
N	Set Event Mask	Nmask Directly sets the Event Status Enable Register (ESE) where mask is in the form of the number nnn such that $000 \leq \text{nnn} \leq 255$ is summed from the following conditions: 128 - ESB on Power On 064 - ESB on Buffer 75% Full 032 - ESB on Command Error 016 - ESB on Execution Error 008 - ESB on Device Dependent Error 004 - ESB on Query Error 002 - ESB on Stop Event 001 - ESB on Acquisition complete 000 - ESB on Clear Event Mask
		N? Query the Event mask.

Command	Syntax	Description
O	Set Digital Outputs	Obank1 , bank2 , bank3 , bank4 Set any of the 32 digital outputs (separated into four 8-bit banks) to a specified setting, where bankn (n = 1, 2, 3, 4) is an argument in the form of the number nnn such that $000 \leq nnn \leq 255$ when converted to binary format represents the desired settings for the 8-bit bank.
	O?	Query current state of digital output.
P	Program Trigger Times	Pstart , stop Set the <i>Trigger</i> and/or <i>Stop</i> times for an acquisition configured for start and/or stop on absolute time, where start and stop are in the standard Time/Date input format: hh:mm:ss:t,MM/DD/YY where hh is in hours, mm is in minutes, ss is in seconds, t is in tenths of a second, MM is the month, DD is the day, and YY is the year.
	P?	Query current start and stop times.
Q	Set Query Terminator	Qresp , hll , scan , block , sep Set the query terminators with the following parameters: resp is the response terminator, hll is the channel terminator, scan is the scan terminator, and block is the <i>Trigger Block</i> terminator. sep is the separator terminator which determines whether or not a separator character should be used. Valid options for sep are: 0 - Place no separators in returned buffered scan data when it is read, and 1 - Place a separator whose value is determined by the current <i>Set User Terminator (V)</i> command setting into the returned buffer data when it is read.
	Q?	Query current terminator settings.
QC?	Query Card Data	QC? Read back the card identification and calibration information from the scanning card previously selected by the <i>Select Card (C#)</i> command.
R	Read Buffered Data	Rtype Read scan data from the Acquisition Buffer where type is the type of data request being made. Valid options for type are: 1 - Read the oldest scan currently residing in the Acquisition Buffer, 2 - Read the oldest complete <i>Trigger Block</i> currently residing in the Acquisition Buffer, and 3 - Read all the scan data that currently resides in the Acquisition Buffer.
	R?	Query the contents of the Acquisition Buffer.
R#	Read Last Readings	R#chans Queries the last readings from the HLL Registers for specified channels. chans may be in two forms: chan (for a single channel where $1 \leq \text{chan} \leq \text{max}$) or first-last (for a range of channels where $1 \leq \text{first} < \text{last} \leq \text{max}$), where max = 992 for the TempScan/1100 and max = 744 for the MultiScan/1200.
S	Set Real-Time Clocks	Stime Set the internal real-time clock where time is in the standard Time/Date input format: hh:mm:ss:t, MM/DD/YY where hh is in hours, mm is in minutes, ss is in seconds, t is in tenths of a second, MM is the month, DD is the day, and YY is the year.
	S?	Query the internal real-time clock.
T	Set Trigger Configuration	Tstart , stop , re-arm , sync Configure an acquisition of scan data with the following parameters: start is the start event and stop is the stop event re-arm determines if the unit should continue acquiring after the first acquisition completes, where 1 is on and 0 is off. sync determines if acquisition events should be synchronized with the internal timebases, where 1 is on and 0 is off.
	T?	Query the present trigger configuration

Command	Syntax	Description	
U	User Status	Ureq Request information about various internal conditions of the unit where req refers to one of the following request types: 0 - Query and clear the Event Status Register (ESR) 1 - Query the Status Byte Register (STB) 2 - Query and clear the Calibration Status Register (CSR) 3 - Query the current system settings 4 - Query the current High/Low/Last (HLL) Registers 5 - Query and clear the current High/Low/Last (HLL) Registers 6 - Query the Buffer Status String 7 - Query the assigned alarm outputs 8 - Query the configured channels 9 - Query the digital inputs 10 - Query the installed memory option 11 - Query the current alarm channels 12 - Query the Time/Date stamping of the last calibration 13 - Query the last scan read 14 - Query the card ID types 15 - Query the product information 16 - Query the measuring parameters (MultiScan/1200 only) 17 - Query Root Mean Square (RMS) (MultiScan/1200 only) 18 - Query the acquisition states and various system flags	
V	Set User Terminator	Vval	Set the User Terminator value to any character whose numeric value (ASCII value) val is in the range 0 to 255.
		V?	Query the present User Terminator value.
W#	Set Averaging Weight (MultiScan/1200 only)	W#wt Specify the number of samples to average in line cycle integration / high-speed multi-channel mode where wt is the averaging weight. Valid options for wt are: 1, 2, 4, 8, 16, 32 (default), 64, 128, and 256.	
X	Execute	X Execute preceding command string.	
Y	Set Counts	Ypre, post, stop	Set acquisition counts where pre is the <i>Pre-Trigger</i> count, post is the <i>Post-Trigger</i> count and stop is the <i>Post-Stop</i> count.
		Y?	Query current acquisition count selections.
Command Extension	Syntax	Description	
?	Query	? Query the present configuration or mode of the command preceding the ?	

Command Reference

The following pages provide the command set for the TempScan/1100 and MultiScan/1200. For each command, the command name, the descriptive name, and the command description are given. In turn, the command description includes the following format.

Command Description Format

Type

This item refers to the part of the system that the command acts upon. The defined *Types* are as follows:

- **Acquisition:** This command type refers to those commands which affect how the scans/channels are acquired.
- **Buffer:** This command type refers to those commands which affect the buffer operations and/or pointers.
- **Calibration:** This command type refers to those commands which affect instrument calibration.
- **Channel:** This command type refers to those commands which affect channel configuration and/or acquisition.
- **System:** This command type refers to those commands which affect general system functionality.

Execution

This item refers to the point in time which an interpreted command is executed. The defined *Executions* are as follows:

- **Immediate:** This command execution indicates that the command will be executed immediately upon successful parsing of the command and instrument parameters.
- **Deferred:** This command execution indicates that the command will be saved and executed later (after successfully parsing and performing an *Execute (x)* command).

Banner

Most of the commands are used with both the TempScan/1100 and MultiScan/1200 units. However, in several instances, a banner like those shown below, will indicate whether a command is used with the TempScan/1100 unit only, or with the MultiScan/1200 unit only.

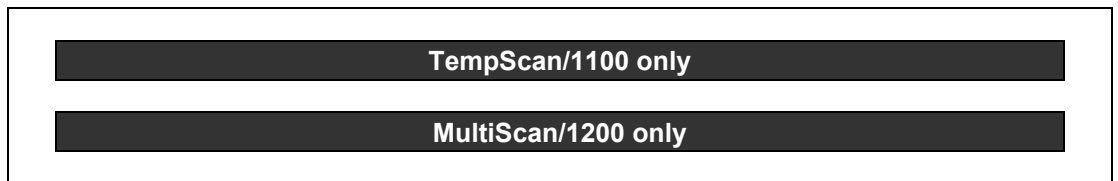

The Commands

The following pages presents the API Command Reference for both the TempScan/1100 and MultiScan/1200 units in alphabetical order by command syntax.

@ - Trigger On Command

TYPE	Acquisition	
EXECUTION	Deferred	
SYNTAX	@	Trigger upon receipt of an @
DESCRIPTION		
<p>The <i>Trigger On</i> (@) command will start or stop the acquisition accordingly when the start or stop arguments of the <i>Set Trigger Configuration</i> (T) command is set to 1 (trigger on). The T command is used as a trigger source and follows the same rules as other trigger sources as defined by the T command.</p> <p>The @ command is valid only when an acquisition is configured such that either the <i>Trigger</i> (trigger start event) and/or <i>Stop</i> (trigger stop event) is defined as the <i>Trigger On</i> (@) command. Otherwise, if this command is issued such that either the Trigger and/or Stop are not defined as the <i>Trigger On</i> (@) command, an error condition will occur.</p>		
EXAMPLE		
<code>PRINT#1, "OUTPUT07;T1,1,0,0X"</code>	' Configure an acquisition with both <i>Trigger</i> and <i>Stop</i> being assigned the <i>Trigger On</i> (@) command	
<code>PRINT#1, "OUTPUT07; @X"</code>	' Start the acquisition	
<code>SLEEP 10</code>	' Wait 10 seconds to collect data	
<code>PRINT#1, "OUTPUT07; @X"</code>	' Stop the acquisition	

*B - Flush Acquisition Buffer

TYPE	Buffer	
EXECUTION	Immediate	
SYNTAX	*B	Flush any data currently in the Acquisition Buffer
DESCRIPTION		
<p>The <i>Flush Acquisition Buffer</i> (*B) command will flush any data currently in the Acquisition Buffer. Upon execution of this command, all data currently in the buffer will be deleted and made unavailable to be read. This command should only be used when it is determined that the data in the buffer is no longer needed or may be corrupt. Once this command is executed, data in the buffer is irrevocably lost.</p>		
EXAMPLE		
<pre> PRINT#1,"SPOLL07" INPUT#2,S% IF (S% AND 128) = 128 THEN PRINT#1,"OUTPUT07; *BX" ENDIF </pre>		
<p style="margin-left: 100px;">‘ Serial Poll the unit ‘ Get the Serial Poll response ‘ Check for Buffer Overrun ‘ Data may be corrupt, flush the Acquisition Buffer</p>		

*C - Clear Channel Configuration

TYPE	Channel	
EXECUTION	Deferred	
SYNTAX	*C	Clear out the channel configuration so that no channels are configured
DESCRIPTION		
<p>The <i>Clear Channel Configuration</i> (*C) command will clear out the channel configuration so that no channels are configured. After this command has been performed, channel readings will not be updated; therefore, no HLL or Acquisition Buffer updates will be performed until a new configuration is entered via the <i>Configure Channels</i> (C) command. This *C command may be used when the present configuration is no longer acceptable and you wish to reconfigure channels from scratch.</p>		
EXAMPLE		
<pre>PRINT#1,"OUTPUT07; *CX" ' Clear all channel configurations PRINT#1,"OUTPUT07; C1,1X" ' Configure Channel 1 of thermocouple Type J</pre>		

*F - Restore Factory Settings

TYPE	System	
EXECUTION	Immediate	
SYNTAX	*F	Restore unit to factory configuration
DESCRIPTION		
<p>The <i>Restore Factory Defaults</i> (*F) command may be used to restore the unit to the same configuration it had when it left the factory. Issuing this command will cause the unit to load the factory default configuration into the working configuration. This command may not be issued while an acquisition is configured since it will cause certain acquisition-dependent settings to change. Issuing this command while an acquisition is configured will cause a Command Conflict Error to occur.</p> <p>For more information on the factory default configuration, see section <i>Power-Up Configuration</i> in the chapter <i>System Configuration</i>.</p> <p>Note: Issuing the *F command will cause any previously defined configuration to be irrevocably lost. The calibration factors for the master unit and its slaves, however, will remain intact.</p>		
EXAMPLE		
<pre> PRINT#1,"OUTPUT07;Q?T?Y?X" ' Retrieve some current configuration settings PRINT#1,"ENTER07" ' Get the settings INPUT A\$ ' Screen shows the current settings Q1,7,7,7,0 T0,3,0,0 Y100,1000,0 PRINT#1,"OUTPUT07;*FX" ' Restore factory default configuration PRINT#1,"OUTPUT07;Q?T?Y?X" ' Retrieve some current configuration settings PRINT#1,"ENTER07" ' Get the settings INPUT A\$ ' Screen shows the new settings Q1,0,0,0,0 T0,0,0,0 Y0,0,0 </pre>		

*G - Set RTD Gain Calibration Reference

TempScan/1100 only		
TYPE	Calibration	
EXECUTION	Immediate	
SYNTAX	*Ggain	Set RTD Gain Calibration reference point to specified number of ohms. gain is the reference point in the form of a real number nnn.nn .
	G?	Query the present reference point setting.
DESCRIPTION		
<p>RTD (Resistance Temperature Device) Gain Calibration requires a precision resistance source to be applied to Channel 1 of each RTD card being calibrated. The factory default reference resistance (invoked with reference point = 0.00) is 384.4 ohms (830.0°C).</p> <p>The <i>Set RTD Gain Calibration Reference</i> (*G) command allows you to change the reference resistance prior to calibrating the gain. This is useful if individual calibration labs have different precision resistance sources and when temperature measurement exclusivity at lower temperatures can be made even more accurate by calibrating at a lower reference point.</p> <p>For more information on manually calibrating the TempScan/1100, see chapter <i>System Calibration</i>.</p>		
EXAMPLE		
PRINT#1, "OUTPUT07;*G247.04X"	‘ Set the RTD Gain Calibration reference point to 247.04 ohms (400.0°C).	
PRINT#1, "OUTPUT07;K12345X"	‘ Enter <i>Calibration Mode</i>	
PRINT#1, "OUTPUT07;H1X"	‘ Short out Channel 1 on RTD card in master unit	
PRINT#1, "OUTPUT07;H1X"	‘ Calibrate offset for RTD card in master unit	
PRINT#1, "OUTPUT07;G1,17X"	‘ Apply precision resistance of 247.04 ohms on Channel 1 of RTD card in master unit	
PRINT#1, "OUTPUT07;G1,17X"	‘ Calibrate gain for 4-wire RTD for RTD card in master unit	
PRINT#1, "OUTPUT07;EX"	‘ Remove precision voltage	
PRINT#1, "OUTPUT07;EX"	‘ End <i>Calibration Mode</i>	

*K - Change Calibration Keyword

TYPE	Calibration	
EXECUTION	Immediate	
SYNTAX	*Kkey	Change the calibration keyword, where key is the keyword in the form of a 5-digit number nnnnn . Therefore the password can be no longer than 5 characters.
DESCRIPTION		
<p>Note: This command is only for advanced users who perform their own calibration. It is not necessary for normal, everyday operation.</p> <p>The <i>Change Calibration Keyword (*K)</i> command allows the changing of the calibration keyword which is a user-defined password. This password is a safety feature to prevent unauthorized personnel from entering <i>Calibration Mode</i> and potentially altering calibration constants. The new keyword must be a 5-digit decimal number. Once the keyword is set, it will thereafter be used by the <i>Enter Calibration Mode (K)</i> command to determine entry into <i>Calibration Mode</i>.</p> <p>For more information on manual calibration, see chapter <i>System Calibration</i>.</p> <p>Note: This command is only valid when the calibration protection is disabled via the rear DIP microswitch 9.</p>		
EXAMPLE		
<pre> PRINT#1, "OUTPUT07;K12345X" ' Enter Calibration Mode. Keyword = 12345 PRINT#1, "OUTPUT07;U2X" ' Check for keyword error PRINT#1, "ENTER07" INPUT#2, C% ' Get the Calibration Status Register (CSR) IF (C% AND 16) THEN PRINT,"ERROR - INVALID KEYWORD" SLEEP 5 ' If so, wait until keyword check jumper is disabled PRINT#1, "OUTPUT07;*K67890X" ' Enter new Keyword = 67890 ENDIF PRINT#1, "EX" ' End Calibration Mode </pre>		

*P - Adjust Calibration Card Pots

TYPE	Calibration	
EXECUTION	Immediate	
SYNTAX	*Pchan	Select voltage level to be enabled for adjustment. Valid options for chan are: 01 - Enable -4.4 Volt Source on calibration card, 02 - Enable +4.4 Volt Source on calibration card, and 03 - Select 0 Volts Ground.
DESCRIPTION		
<p>Note: This command is only for advanced users who perform their own calibration. It is not necessary for normal, everyday operation.</p> <p>The <i>Adjust Calibration Card Pots (*P)</i> command is used to enable the -4.4 Volt or +4.4 Volt source on the special calibration card to allow for their adjustment. A secondary, diagnostic use for this command is to program the channel sequencer to "sit" on a specified channel without changing address lines, accessing temperature sensors, or making/breaking relay contacts.</p>		
EXAMPLE		
<pre>PRINT#1,"OUTPUT07;K12345X" ' Enter Calibration Mode PRINT#1,"OUTPUT07;*P02X" ' Enable -4.4 Volt Source PRINT#1,"OUTPUT07;*P01X" ' Adjust -4.4 Volt Source PRINT#1,"OUTPUT07;*P01X" ' Enable +4.4 Volt Source PRINT#1,"OUTPUT07;EX" ' Adjust +4.4 Volt Source PRINT#1,"OUTPUT07;EX" ' End Calibration Mode</pre>		

*R - Reset Power-On

TYPE	System	
EXECUTION	Immediate	
SYNTAX	*R	Power-on reset. Equivalent to a hardware reset.
DESCRIPTION		
<p>The <i>Reset Power-On (*R)</i> command has the same effect on the unit as removing and re-applying power. All buffer data and channel configurations are erased. Meanwhile, the IEEE 488 bus commands Device Clear (DCI) and Selected Device Clear (SDC) do not have this effect. They clear only the command input buffer, the output queue, and any pending commands.</p> <p>Note: Because the <i>Reset Power-On (*R)</i> command performs a full power-on reset, 3 or 4 seconds are required before you can communicate with the unit. A total of at least 5 seconds is required before normal operations can take place.</p> <p>Note: Issuing the <i>Set Power-Up Configuration (*S)</i> command *S1 and then power-cycling the unit, or issuing the <i>Reset Power-On (*R)</i> command will cause any previously defined configuration to be irrevocably lost. However, the calibration factors for the unit and its slaves will remain intact.</p>		
EXAMPLE		
<pre> PRINT#1, "OUTPUT07;*RX" ' Restore power-on settings to the unit SLEEP 4 ' Wait 4 seconds to restore communication WHILE (S% and 4) = 0 ' Keep checking the Serial Poll response of the unit until it is ready PRINT #1, "SPOLL07" INPUT#2, S% WEND </pre>		

*S - Set Power-Up Configuration

TYPE	System	
EXECUTION	Immediate	
SYNTAX	*Smode	Specify power-up configuration mode. Valid options for mode are: 0 - Power up under last known configuration (default). 1 - Power up under factory default configuration.
DESCRIPTION		
<p>With the <i>Set Power-Up Configuration (*S)</i> command, specifying the mode to be 0 will cause the unit to load its last known configuration when it is powered on or when the <i>Reset Power-On (*R)</i> command is issued. The last known configuration will be exactly the same as the configuration it had when it was last powered down or a <i>*R</i> command was issued. Specifying this mode will insure that the unit will always come up with the configuration which has most recently been defined. Using this mode is convenient if it is undesirable to reconfigure the unit every time it is powered up or a <i>*R</i> command is issued.</p> <p>Specifying the mode to be 1 will cause the unit to load the factory default configuration when it is powered on or when a <i>*R</i> command is issued. Using this mode is the same as power-cycling the unit then issuing the <i>Restore Factory Settings (*F)</i> command. For more information on the factory default configuration, see section <i>Power-Up Configuration</i> in the chapter <i>System Configuration</i>.</p> <p>Note: Issuing the <i>Set Power-Up Configuration (*S)</i> command <i>*S1</i> and then power-cycling the unit, or issuing the <i>Reset Power-On (*R)</i> command will cause any previously defined configuration to be irrevocably lost. However, the calibration factors for the unit and its slaves will remain intact.</p>		
EXAMPLE		
<pre>PRINT#1, "OUTPUT07;Q?T?Y?X" ' Retrieve some current configuration settings PRINT#1, "ENTER07" ' Get the settings INPUT A\$ ' Screen shows settings Q1,7,7,7,0 T1,3,0,0 Y100, 1000,0 PRINT#1, "OUTPUT07;*S1X" ' Configure to power up with factory defaults PRINT#1, "OUTPUT07;*RX" ' Reset the unit SLEEP 5 ' Wait for the unit to reset PRINT#1, "OUTPUT07;Q?T?Y?X" ' Retrieve some current configuration settings PRINT#1, "ENTER07" ' Get the settings INPUT A\$ ' Screen shows settings Q1,0,0,0,0 T0,0,0,0 Y0,0,0</pre>		

*T - Set Scan Time Stamping

TYPE	System	
EXECUTION	Immediate	
SYNTAX	*Tstate	Specify whether or not scan time stamping will be enabled. Valid options for state are: 0 - Disable scan time stamping (default), 1 - Enable absolute time stamping, and 2 - Enable relative time stamping.
DESCRIPTION		
<p>The <i>Set Scan Time Stamping (*T)</i> command, when enabled, will append a Time/Date stamping to each scan being output by the unit to the controller. This Time/Date output data can be in absolute or relative formats.</p> <p>When Engineering Units format is selected via the <i>Set Data Format (F)</i> command:</p> <ul style="list-style-type: none"> • Absolute time stamping is in the format: hh:mm:ss.mil,MM/DD/YY. • Relative time stamping is in the format: ±hh:mm:ss.mil,DDDDDD. (Negative values indicate <i>Pre-Trigger</i> scans, whereas positive values indicate <i>Post-Trigger</i> scans.) <p>When Binary format is selected via the <i>Set Data Format (F)</i> command, the Time/Date stamping is returned as ten 8-bit bytes in 2h (two-digit hexadecimal) format, as follows:</p> <ul style="list-style-type: none"> • Absolute time stamping is in the format: hmstuvwMDY. • Relative time stamping is in the format: hmstuvwDEF. <p>When ASCII Counts format is selected via the <i>Set Data Format (F)</i> command, the output data is interpreted as Engineering Units.</p> <p>For more information on data formats, see section <i>Data Format Configuration</i> in the chapter <i>System Configuration</i>. For more information on time stamping, see section <i>Stamping Configuration</i> in the chapter <i>System Configuration</i>.</p> <p>Note: Relative time stamping is not valid when you attempt to use it in conjunction with continuous, gap-free acquisitions with two timebases.</p> <p>Note: With MultiScan/1200 only, time stamping is not valid in single-channel high-speed burst mode.</p>		
EXAMPLE		
<pre>PRINT#1,"OUTPUT07;*T1X" ' Enable absolute time stamping PRINT#1,"OUTPUT07;*T2X" ' Enable relative time stamping PRINT#1,"OUTPUT07;*T0X" ' Disable scan time stamping</pre>		

*W - Set Software Digital Filtering

TempScan/1100 only		
TYPE	System	
EXECUTION	Deferred	
SYNTAX	*Wmode	Specify whether or not software digital filtering for thermocouple cards will be enabled. Valid options for mode are: 0 - Disable digital filtering for thermocouple cards, and 1 - Enable digital filtering for thermocouple cards (default).
DESCRIPTION		
<p>As a standard feature, the TempScan/1100 employs an advanced software digital filter to ensure quiet and accurate thermocouple input. This feature is enabled as part of the factory default settings. Using the <i>Set Software Digital Filtering (*W)</i> command, this digital filtering feature can be disabled in order to improve reaction response time, or re-enabled to reinstate the feature.</p> <p>Note: This feature is only valid for the TempTC/32B thermocouple scanning card for the TempScan/1100.</p>		
EXAMPLE		
<pre>PRINT#1, "OUTPUT07; *W0X" ' Disable software filtering PRINT#1, "OUTPUT07; *W1X" ' Enable software filtering</pre>		

A - Assign Digital Alarm Output

TYPE	System	
EXECUTION	Deferred	
SYNTAX	Achans, output	Set alarm condition where chans is the channel(s) to assign to the digital output. chans may be in two forms: chan (for a single channel where $1 \leq \text{chan} \leq \text{max}$) or first-last (for a range of channels where $1 \leq \text{first} < \text{last} \leq \text{max}$), where max = 992 for the TempScan/1100 and max = 744 for the MultiScan/1200. output is the digital output number with which to associate the channel(s), where $1 \leq \text{output} \leq 32$. The value of 0 (null) will unassign a digital alarm condition by disassociating the channel(s) from any digital output.
	A?	Query channels assigned to digital output.
DESCRIPTION		
<p>The <i>Assign Digital Alarm Output (A)</i> command is used to assign alarm states of a particular channel, or range of channels, to individual outputs of the 32 available digital alarm outputs.</p> <p>To use the alarms, the relevant channels must be part of the channel scan. After an acquisition has been configured and armed, the alarms will be enabled and monitored. Since alarming is totally independent of buffered operations, the assignment of trigger events or scan intervals is not required.</p> <p>If preferred, an alarm event for a specific channel can be used as a stimulus for a digital (TTL) output signal. In turn, this signal can be used to set off an audible alarm (user-supplied) or to communicate to another device that the alarm state has occurred.</p> <p>Thirty-two (32) digital alarm outputs are available via the TempScan/1100 or MultiScan/1200 rear-panel DB50 connector. Although analog input channels on the Exp/10A or Exp/11A expansion unit can be used to stimulate alarms, neither of these expansion units provides digital alarm outputs. Consequently, regardless of the number of connected expansion units, the TempScan/1100 or MultiScan/1200 system can only provide 32 digital alarm outputs.</p> <p>Note: To enable alarm monitoring prior to, or have an alarm condition serve as, the <i>Trigger</i> or <i>Stop</i> event, you must first configure the acquisition with at least one <i>Pre-Trigger</i> scan.</p>		
EXAMPLE		
<pre>PRINT#1,"OUTPUT07;C1-32, 1, -100.0, 100.0, 1.0X" ' Configure Channels 1 - 32 with a low setpoint of -100.0, a high setpoint of 100.0, and a hysteresis of 1.0 PRINT#1,"OUTPUT07;A1,1X" ' Assign Channel 1 alarm to digital output 1 PRINT#1,"OUTPUT07;A2-16,2X" ' Assign Channels 2 - 16 alarms to digital output 2 PRINT#1,"OUTPUT07;A17-25,3X" ' Assign Channels 17 - 25 alarms to digital output 3 PRINT#1,"OUTPUT07;A26-32,32X" ' Assign Channels 26 - 32 alarms to digital output 32</pre>		

A# - Set Scan Alarm Stamping

TYPE	System	
EXECUTION	Deferred	
SYNTAX	A#state	Specify whether or not scan alarm stamping will be enabled. Valid options for state are: 0 - Disable scan alarm stamping (default), and 1 - Enable scan alarm stamping.
DESCRIPTION		
<p>The <i>Set Scan Alarm Stamping (A#)</i> command, when enabled, is used to stamp the alarm states of the 32 digital alarm outputs to the end of each scan as the scans occur in real time. The alarm status consists of 32 bits, grouped into four 8-bit bytes: Bits 07-00, 15-08, 23-16, and 31-24. Each of these 32 bits is identified with a 1 signifying alarm on, or a 0 signifying alarm off.</p> <p>In the following data formats, the alarm status will be stamped to each scan in the corresponding patterns:</p> <ul style="list-style-type: none"> • Binary Low-High-Byte format: Four 8-bit Bytes 1 through 4, where: <ul style="list-style-type: none"> Byte 1: Bits 07 through 00. Byte 2: Bits 15 through 08. Byte 3: Bits 23 through 16. Byte 4: Bits 31 through 24. • Binary High-Low-Byte format: Four 8-bit Bytes 1 through 4, where: <ul style="list-style-type: none"> Byte 1: Bits 15 through 08. Byte 2: Bits 07 through 00. Byte 3: Bits 31 through 24. Byte 4: Bits 23 through 16. • ASCII format: Four 8-bit bytes in Binary format converted to twelve bytes in printable ASCII format: TwwwTxxxTyyyTzzz, where: <ul style="list-style-type: none"> T = User terminator. www = Three-digit decimal value of Bits 07 through 00. xxx = Three-digit decimal value of Bits 15 through 08. yyy = Three-digit decimal value of Bits 23 through 16. zzz = Three-digit decimal value of Bits 31 through 24. <p>For more information on alarm stamping, see section <i>Stamping Configuration</i> in the section <i>System Configuration</i>.</p> <p>Note: In an 8-bit byte, Bits 00 through 07 correspond to digital input/output (DIO) lines 1 through 8. Also, Bit <i>n</i> corresponds to the decimal value 2^n (where <i>n</i> is an integer from 00 to 07).</p> <p>Note: With MultiScan/1200 only, alarm stamping is not valid in single-channel high-speed burst mode, since alarms are not monitored.</p> <p>Note: If digital input stamping has also been enabled via the <i>Set Digital Input Stamping (I#)</i> command, then the digital input states will be stamped after the scan alarm output states have been stamped.</p> <p>Note: Data in Binary format is not printable. The Binary data must be converted to ASCII format for printability.</p>		
EXAMPLE		
<pre>PRINT#1, "OUTPUT07;A#1X" ' Enable scan alarm stamping PRINT#1, "OUTPUT07;A#0X" ' Disable scan alarm stamping</pre>		

C - Configure Channels

TYPE	Channel																																																										
EXECUTION	Deferred																																																										
SYNTAX	C <i>chans</i> , <i>type</i> [, [<i>lowsp</i>], [<i>highsp</i>], [<i>hyst</i>]]	Configure the channels for the master unit and its slave units. chans and type are required arguments, while lowsp , highsp and hyst are optional. chans may be in two forms: chan (for a single channel where $1 \leq \text{chan} \leq \text{max}$) or first-last (for a range of channels where $1 \leq \text{first} < \text{last} \leq \text{max}$), where max = 992 for the TempScan/1100 and max = 744 for the MultiScan/1200. The chassis is chan = 0. type is the type to assign to those channels. The value of 0 (null) will remove the affected channel from the scan group.																																																									
	C?	Query current channel configuration.																																																									
DESCRIPTION																																																											
<p>The optional arguments lowsp, highsp and hyst are the low setpoint, high setpoint and hysteresis values, respectively, for the <i>Configure Channels (C)</i> command. These arguments are only needed if it is desired to configure alarms on the specified channel(s). The format for these optional arguments follow the rules for readings input defined under the <i>Set Data Format (F)</i> command.</p> <p>The channel type is used by the unit to determine how a certain channels readings are to be interpreted. Because of this fact, defining the channel type is critical to the proper configuration of the channel. Each channel must be assigned a channel type in order for it to be included in the scan group. Assigning a channel type of 0 will remove that channel from the scan group. Reserved types are non-assignable types that are reserved to the internal processes of the unit. Among these types, 90 and 91 are reserved for chassis calibration. Note that specifying a reserved type will cause an error.</p> <p>Note: Specifying a reserved type will cause an error.</p> <p>Note: Since the <i>Configure Channels (C)</i> command is a deferred command, the channel(s) will not actually be configured until the <i>Execute (X)</i> command is processed. Also, since the configuring of channels takes a good deal of processor time, it is recommended that as many <i>Configure Channels (C)</i> commands should be placed on one command line as possible. This will avoid unnecessary processing time overhead when configuring many channels.</p> <p>The following table outlines the channel types for the TempScan/1100 and the MultiScan/1200 units:</p>																																																											
<table border="1" style="width: 100%; border-collapse: collapse; text-align: center;"> <thead> <tr> <th style="width: 25%;">Channel Types</th> <th style="width: 50%;">TempScan/1100 Description</th> <th style="width: 25%;">MultiScan/1200 Description</th> </tr> </thead> <tbody> <tr> <td>0</td> <td>Null</td> <td>Null</td> </tr> <tr> <td>1-9</td> <td>Thermocouple Card</td> <td>Thermocouple Card</td> </tr> <tr> <td>10</td> <td>Thermocouple Card</td> <td>(N/A)</td> </tr> <tr> <td>11</td> <td>Thermocouple Card and Volts Card</td> <td>Volts Card</td> </tr> <tr> <td>12, 13, 14</td> <td>Volts Card</td> <td>Volts Card</td> </tr> <tr> <td>15</td> <td>Reserved</td> <td>Reserved</td> </tr> <tr> <td>16, 17, 18</td> <td>RTD Card</td> <td>Reserved</td> </tr> <tr> <td>19</td> <td>RTD Card</td> <td>(N/A)</td> </tr> <tr> <td>20</td> <td>Reserved</td> <td>High-Voltage Card</td> </tr> <tr> <td>21, 22</td> <td>(N/A)</td> <td>High-Voltage Card</td> </tr> <tr> <td>23, 24, 25, 26</td> <td>(N/A)</td> <td>Volts Card</td> </tr> <tr> <td>27</td> <td>(N/A)</td> <td>(N/A)</td> </tr> <tr> <td>28, 29</td> <td>(N/A)</td> <td>High-Voltage Card</td> </tr> <tr> <td>30</td> <td>Reserved</td> <td>High-Voltage Card</td> </tr> <tr> <td>31-50</td> <td>Thermocouple Card</td> <td>Thermocouple Card</td> </tr> <tr> <td>51-59</td> <td>Thermocouple Card</td> <td>(N/A)</td> </tr> <tr> <td>60-99</td> <td>Reserved</td> <td>Reserved</td> </tr> <tr> <td>111-127</td> <td>Reserved</td> <td>Reserved</td> </tr> </tbody> </table>			Channel Types	TempScan/1100 Description	MultiScan/1200 Description	0	Null	Null	1-9	Thermocouple Card	Thermocouple Card	10	Thermocouple Card	(N/A)	11	Thermocouple Card and Volts Card	Volts Card	12, 13, 14	Volts Card	Volts Card	15	Reserved	Reserved	16, 17, 18	RTD Card	Reserved	19	RTD Card	(N/A)	20	Reserved	High-Voltage Card	21, 22	(N/A)	High-Voltage Card	23, 24, 25, 26	(N/A)	Volts Card	27	(N/A)	(N/A)	28, 29	(N/A)	High-Voltage Card	30	Reserved	High-Voltage Card	31-50	Thermocouple Card	Thermocouple Card	51-59	Thermocouple Card	(N/A)	60-99	Reserved	Reserved	111-127	Reserved	Reserved
Channel Types	TempScan/1100 Description	MultiScan/1200 Description																																																									
0	Null	Null																																																									
1-9	Thermocouple Card	Thermocouple Card																																																									
10	Thermocouple Card	(N/A)																																																									
11	Thermocouple Card and Volts Card	Volts Card																																																									
12, 13, 14	Volts Card	Volts Card																																																									
15	Reserved	Reserved																																																									
16, 17, 18	RTD Card	Reserved																																																									
19	RTD Card	(N/A)																																																									
20	Reserved	High-Voltage Card																																																									
21, 22	(N/A)	High-Voltage Card																																																									
23, 24, 25, 26	(N/A)	Volts Card																																																									
27	(N/A)	(N/A)																																																									
28, 29	(N/A)	High-Voltage Card																																																									
30	Reserved	High-Voltage Card																																																									
31-50	Thermocouple Card	Thermocouple Card																																																									
51-59	Thermocouple Card	(N/A)																																																									
60-99	Reserved	Reserved																																																									
111-127	Reserved	Reserved																																																									
See the following tables for details:																																																											

Thermocouple Scanning Cards

Thermocouple Type	Assignable Channel Types					
	Normal Operation	For Troubleshooting purposes only, not for normal operation. These special types are valid only in degrees Celsius.				
		Same as normal operation but without temperature sensor adjustment	Without temperature sensor adjustment (i.e. raw A/D input of the T/C type)		Temp. sensor values only, linearized	Temp. sensor values only, not linearized (i.e. raw A/D input of the temp. sensors)
(Temp Scan /1100 only)	(Multi Scan /1200 only)					
J	1	31	51	40	41	50
K	2	32	52	40	42	50
T	3	33	53	40	43	50
E	4	34	54	40	44	50
R	5	35	55	40	45	50
S	6	36	56	40	46	50
B	7	37	57	40	47	50
N (14 gauge)	8	38	58	40	48	50
N (28 gauge)	9	39	59	40	49	50
100 mV with hardware range checking (TempScan /1100 only)	10	(N/A)	(N/A)	(N/A)	(N/A)	(N/A)
100 mV without hardware range checking (TempScan /1100 only)	11	(N/A)	(N/A)	(N/A)	(N/A)	(N/A)

Volts Scanning Cards

Volts Type (Range)	Assignable Channel Types	
	Normal Operation	
	(TempScan /1100 only)	(MultiScan /1200 only)
100 mV DC	11	11
1 V DC	12	12
5 V DC	13	13
10 V DC	14	14
100 mV AC	(N/A)	23
1 V AC	(N/A)	24
5 V AC	(N/A)	25
10 V AC	(N/A)	26

High-Voltage Scanning Cards

High-Voltage Type (Range)	Assignable Channel Types
	Normal Operation
	(Multi Scan /1200 only)
2.5 V DC	20
25 V DC	21
250 V DC	22
2.5 V AC	28
25 V AC	29
250 V AC	30

RTD Card Types

RTD Type	Assignable Channel Types	
	Normal Operation	Raw A/D Input
	(Temp Scan /1100 only)	
3-Wire RTD	16	18
4-Wire RTD	17	19

EXAMPLE

<code>PRINT#1, "OUTPUT07; F0,0X"</code>	' Set Data Format to Engineering Units, degrees C
<code>PRINT#1, "OUTPUT07;*C"</code>	' Clear current channel configuration
<code>PRINT#1, "OUTPUT07;C1,1,-100.0,100.0, 0.5"</code>	' Configure channel for Type J thermocouple with low setpoint of -100.0 °C, high setpoint of 100.0 °C and hysteresis of 0.5 °C
<code>PRINT#1, "OUTPUT07;C33-34,11"</code>	' Configure Channels 33 and 34 for Volts type (100 mV range) and no setpoints
<code>PRINT#1, "OUTPUT07;C65,2"</code>	' Configure Channel 65 for Type K thermocouple with no setpoints
<code>PRINT#1, "OUTPUT07;X"</code>	' Execute the above configuration (The unit is now scanning the above configuration)
<code>PRINT#1, "OUTPUT07;U13X"</code>	' Get the last readings of configured channels
<code>PRINT#1, "ENTER07"</code>	' Retrieve response
<code>INPUT A\$</code>	' Screen shows the last readings
<code> +0034.40</code>	
<code> -0103.00</code>	
<code> +0012.30</code>	
<code> +0004.60</code>	

C# - Select Card

TYPE	Calibration	
EXECUTION	Immediate	
SYNTAX	C#card	Select the card from which subsequent QC? and U12 interrogation will retrieve information. Valid options for card are: 0 - Selects the chassis, 1 - Selects the card in the master unit, 2 - Selects the 1st slave card, 3 - Selects the 2nd slave card, 4 - Selects the 3rd slave card, etc, 30 - Selects the 29th slave card, and 31 - Selects the 30th slave card.
DESCRIPTION		
Using the <i>Select Card (C#)</i> command with a number from the range 1-31 for the parameter card , will cause subsequent <i>Query Card Data (QC?)</i> and <i>User Status (U12)</i> commands to return the calibration factors of the cards by themselves. To return the calibration factors of the cards as part of the system, select a number from the range 101-131 .		
EXAMPLE		
<pre> PRINT#1, "OUTPUT07;C#0X" ' Select chassis PRINT#1, "OUTPUT07;QC?X" ' Read chassis calibration factors PRINT#1, "ENTER07" INPUT #2, A\$ PRINT#1, "OUTPUT07;C#5X" ' Select the fourth slave card - 5 PRINT#1, "OUTPUT07;U12X" ' Read back the Time/Date that card 5 was last calibrated PRINT#1, "ENTER07" INPUT #2, A\$ PRINT#1, "OUTPUT07;C#105X" ' Select the fourth slave card in order to read back the ' calibration factors as part of the system PRINT#1, "OUTPUT07;QC?X" ' Read back the system calibration factors of card 5 PRINT#1, "ENTER07" INPUT #2, A\$ </pre>		

D# - Set Relay Make Time

MultiScan/1200 only		
TYPE	System	
EXECUTION	Deferred	
SYNTAX	D#make	Specify how long to wait after closing a channel relay before reading valid data, where make is the number of 520.833-microsecond intervals.
DESCRIPTION		
<p>The <i>Set Relay Make Time (D#)</i> command allows the user to increase the delay between closing a relay and reading valid channel data. The system powerup default is: make = 6 = 3.125 milliseconds.</p> <p>If common mode voltages on adjacent channels are widely dissimilar, reading inaccuracies can result. This inaccuracy is due to inadequate settling time at the instrumentation amplifier when the unit is scanning between channels. To eliminate these inaccuracies, the settling time can be increased using the D# command as shown in the example below.</p>		
EXAMPLE		
<pre> PRINT#1, "OUTPUT07;M#0X" ' Select line cycle integration/high-speed multichannel mode PRINT#1, "OUTPUT07;W#32X" ' Select number of samples = 32 PRINT#1, "OUTPUT07;D#12X" ' Set Relay Make Time = 12 = 6.25 milliseconds PRINT#1, "OUTPUT07;Y0,10,0X" ' Setup to read 10 past trigger scans PRINT#1, "OUTPUT07;C1-360,1X" ' Enable Channels 1 - 360 for Type J thermocouples PRINT#1, "OUTPUT07;T1,8,0,0X" ' Arm the unit PRINT#1, "OUTPUT07;@X" ' Trigger unit and collect scans </pre>		

E - End Calibration Mode

TYPE	Calibration	
EXECUTION	Immediate	
SYNTAX	E	Terminate <i>Calibration Mode</i>
DESCRIPTION		
<p>Note: This command is only for advanced users who perform their own calibration. It is not necessary for normal, everyday operation.</p> <p>To use this command the unit must be in <i>Calibration Mode</i>. The <i>End Calibration Mode (E)</i> command is then used to take the unit out of <i>Calibration Mode</i>. Once this command has been executed the unit will no longer be in <i>Calibration Mode</i> and the <i>Enter Calibration Mode (K)</i> command must be issued to re-enter <i>Calibration Mode</i>.</p> <p>For more information on manual calibration, see chapter <i>System Calibration</i>.</p>		
EXAMPLE		
PRINT#1, "OUTPUT07;K12345X"	' Enter <i>Calibration Mode</i>	
	' Apply precision voltage	
PRINT#1, "OUTPUT07;H545X"	' Will calculate offsets for slave card 17 (TempScan/1100)	
	' Wait for command to complete	
	' Apply precision voltage of -50.0 mV	
PRINT#1, "OUTPUT07;G545,1X"	' Calibrate negative gain for thermocouple, for slave card 17 (TempScan/1100)	
	' Wait for command to complete	
	' Apply precision voltage of +50.0 mV	
PRINT#1, "OUTPUT07;G545,1X"	' Calibrate positive gain for thermocouple, for slave card 17 (TempScan/1100)	
	' Wait for command to complete	
	' Apply temperature of 90.0 °C	
PRINT#1, "OUTPUT07;J21,2,90.0X"	' Calibrate cold junction offset for Channel 21 on the master unit card	
	' Wait for command to complete	
	' Remove precision voltage	
PRINT#1, "OUTPUT07;EX"	' End <i>Calibration Mode</i>	

E? - Query Error Status

TYPE	System	
EXECUTION	Immediate	
SYNTAX	E?	Returns present error condition with one of the following error codes: E128 – Command Conflict Error. E032 – Open Thermocouple or Range Error. E016 – Trigger Overrun. E008 – Calibration Error. E004 – Channel Configuration Error. E002 – Invalid Device Dependent Command Option (IDDCO). E001 – Invalid Device Dependent Command (IDDC). E000 - No error has occurred.
DESCRIPTION		
<p>When an error has occurred, the <i>ERROR</i> LED indicator on the front panel of the unit turns on. The <i>Query Error Status (E?)</i> command is used to determine the present error condition, as stored in the 8-bit byte of the Error Source Register (ESR). After the execution of an E? command, the unit responds with one of the following error codes:</p> <ul style="list-style-type: none"> • E128: Command Conflict Error (ESC Bit 7). This error indicates that an issued command is in conflict with other issued commands or with the current configuration. This error usually occurs when an issued command cannot be performed because it is incompatible with the current state of the unit. • E032: Open Thermocouple or Range Error (ESC Bit 5). This error occurs when the hardware circuitry detects an open thermocouple, or the software routines detect either that the input A/D data has reached its maximum value or the input data has exceeded its linearization limits. • E016: Trigger Overrun (ESC Bit 4). This error occurs when more than one <i>Trigger</i> (trigger start event) or more than one <i>Stop</i> (trigger stop event) occurs during one <i>Trigger Block</i> acquisition, or when when an unexpected <i>Trigger</i> occurs. • E008: Calibration Error (ESC Bit 3). This error occurs when the calibration is inappropriate or has failed. The Error Indicator Bits (Bits 0 to 5) in the Calibration Status Register (CSR) together map to this bit. • E004: Channel Configuration Error (ESC Bit 2). This error indicates that a channel has been inappropriately configured, either because the channel is not present or because the specified channel type is incompatible with the scanning card type installed. • E002: Invalid Device Dependent Command Option (IDDCO) (ESC Bit 1). This error occurs when a command parameter is out of range or missing. • E001: Invalid Device Dependent Command (IDDC) (ESC Bit 0). This indicates a command syntax error. • E000: No error has occurred. <p>After the execution of a <i>Query Error Status (E?)</i> command, most error conditions are cleared. Error conditions may also be cleared by issuing the following <i>User Status (U)</i> command to the unit: U0 – Query and clear the Event Status Register (ESR). The <i>ERROR</i> LED indicator will remain on until an E? or U0 command is executed to clear the error condition.</p>		
EXAMPLES		
<pre> PRINT#1, "CLEAR07" ' Reset the unit PRINT#1, "OUTPUT07;E?X" ' Request error status PRINT#1, "ENTER07" INPUT#2, A\$ PRINT A\$ ' Display shows E000, no errors occurred E000 PRINT#1, "OUTPUT07;K3 X" ' Send illegal command option. (Note: ERROR LED indicator turns on) PRINT#1, "OUTPUT07;E?X" ' Request error status. (Note: ERROR LED indicator turns off) PRINT#1, "ENTER07" INPUT#2, A\$ PRINT A\$ ' Displays E002 (Invalid Device Dependent Command Option) E002 </pre>		

F - Set Data Format

TYPE	System	
EXECUTION	Deferred	
SYNTAX	Fengr, format	Configure the input and output formats. engr converts the raw data to the engineering units with which you prefer to work. Valid options are: 0 - degrees Celsius (default), 1 - degrees Fahrenheit, 2 - degrees Rankine, 3 - degrees Kelvin, and 4 - Volts. format places the readings in a format with which you prefer to work. Valid options are: 0 - Engineering Units (default), 1 - Binary (Low/High Byte), 2 - Binary (High/Low Byte), and 3 - Counts (ASCII).
	F?	Query the data format.

DESCRIPTION

The *Set Data Format* (F) command configures the input and output data format for data transmissions with the unit, and requires two arguments. The first argument **engr** refers to the specific Engineering Units if applicable, and the second argument **format** refers to the reading format.

The following tables list the valid data input and output formats for Engineering Units, Binary, and Counts.

Data Input Formats

Data Type	Engineering Units	Binary		Counts
		High/Low Byte	Low/High Byte	
Temperature	xxxx.xx °C xxxx.xx °F xxxx.xx °R xxxx.xx °K	(Interpreted as Engineering Units)		±xxxxxx
Volts	+xxx.xxxxxxxx			±xxxxxx
Time/Date (Absolute)	hh:mm:ss.t, MM/DD/YY	(Interpreted as Engineering Units)		(Interpreted as Engineering Units)
Timebase (Scan Interval)	hh:mm:ss.t	(Interpreted as Engineering Units)		(Interpreted as Engineering Units)

Data Output Formats

Data Type	Engineering Units	Binary		Counts
		High/Low Byte	Low/High Byte	
Temperature	xxxx.xx °C xxxx.xx °F xxxx.xx °R xxxx.xx °K	H/L	L/H	±xxxxxx
Volts	+xxx.xxxxxxxx	H/L	L/H	±xxxxxx
Time/Date Stamp (Absolute)	hh:mm:ss.mil, MM/DD/YY	hmstuvwMDY		(Interpreted as Engineering Units)
Time/Date Stamp (Relative)	+hh:mm:ss.mil, DDDDDD	hmstuvwDEF		(Interpreted as Engineering Units)
Timebase (Scan Interval)	hh:mm:ss.t	(Interpreted as Engineering Units)		(Interpreted as Engineering Units)

Data Input & Output Legend

Legend	Engineering Units	Binary	Counts
	x = ASCII digit hh = hours mm = minutes ss = seconds t = tenths mil = milliseconds MM = months DD = days YY = years DDDDDD = days	H = high order byte L = low order byte h = hours m = minutes s = seconds tuvw = microseconds M = months D = days Y = years DEF = days	x = ASCII digit

When the unit is inputting or outputting data, it first references the current reading format. For example, if **format** is 0 (Engineering Units), it will then reference the current settings of the engineering units and then perform the necessary conversion. However, data readings are only converted to the specified engineering units if the associated channel type is a channel that supports those engineering units. For example if the specified channel is a volts channel and the engineering units is 0 (°C), then the reading will be interpreted as volts, not a temperature in °C.

The following table shows the effect of the *Set Data Format* (F) command on reading input/output formats for the commands and queries over which it has control.

Reading Formats

Commands	Engineering Units	Binary		Counts
		High/Low Byte	Low/High Byte	
C, C?, L, L?, U8	Engineering Units	Engineering Units	Engineering Units	Counts
R, R#, U4, U5, U13	Engineering Units	Binary (High/Low)	Binary (Low/High)	Counts

For more information on data formats, see section *Data Format Configuration* in the chapter *System Configuration*.

EXAMPLES

```

PRINT#1, "OUTPUT07:F0,0X"           ' Set the Engineering Units to °C and the
                                     reading format to Engineering Units
PRINT#1, "OUTPUT07;C1,1,-100.0,100.0,1.0X" ' Set points and hysteresis interpreted as °C
PRINT#1, "OUTPUT07; U4X"           ' Retrieve High/Low/Last readings
PRINT#1, "ENTER07"                 ' Returned readings are in Engineering °C
                                     format

LINE INPUT #2, A$
PRINT A$

PRINT#1, "OUTPUT07;F1,1X"           ' Set the Engineering Units to °F and reading
                                     format to Binary Low/High Byte
PRINT#1, "OUTPUT07;C1,1,-100.0,100.0,1.0X" ' Set points and hysteresis interpreted as °F
PRINT#1, "OUTPUT07;U4X"           ' Retrieve High/Low/Last readings
PRINT#1, "ENTER07"                 ' Returned readings in Binary Low/High format

LINE INPUT #2, A$
PRINT A$

```

F# - Set Burst Mode Frequency

MultiScan/1200 only		
TYPE	System	
EXECUTION	Deferred	
SYNTAX	F#freq	Select burst mode sampling frequency where freq is a real number and where $38.5 \leq \text{freq} \leq 20000.0$ Hertz (default).
DESCRIPTION		
<p>The <i>Set Burst Mode Frequency (F#)</i> command is used to select the channel sampling frequency when the MultiScan/1200 is in single-channel high-speed burst mode. For more information on burst mode, see section <i>Measuring Modes (MultiScan/1200 Only)</i> in the chapter <i>System Configuration</i>.</p> <p>For AC measurements where the RMS (Root Mean Square) value is to be returned via the following <i>User Status (U)</i> command – Query measuring mode parameters (U16) – it is your responsibility to program a frequency which will yield a sufficient whole even number of samples per line cycle in order to compute the RMS accurately. In general, for AC measurements, the frequency should equal $(2n * 60)$ Hz where n is a positive integer.</p> <p>For more information on MultiScan/1200 measuring mode parameters, see section <i>Measuring Modes (MultiScan/1200 Only)</i> in the chapter <i>System Configuration</i>, and see commands <i>Set Measuring Mode (M#)</i> and <i>Set Averaging Weight (W#)</i>.</p>		
EXAMPLE		
<pre>PRINT#1, "OUTPUT07;F#15000.0X" ' Select 15 KHz sampling frequency PRINT#1, "OUTPUT07;F#100.5X" ' Select 100.5 Hz sampling frequency</pre>		

G - Calibrate Channel Gain

TYPE	Calibration	
EXECUTION	Immediate	
SYNTAX	Gchan, type	Calibrate the correction gain constants for given option card where chan is the channel number such that $1 \leq \text{chan} \leq \text{max}$, where max = 992 for the TempScan/1100 and max = 744 for the MultiScan/1200. The chassis is chan = 0. type is the channel type.
DESCRIPTION		
<p>Note: This command is only for advanced users who perform their own calibration. It is not necessary for normal, everyday operation.</p> <p>Active only in <i>Calibration Mode</i>, the <i>Calibrate Channel Gain (G)</i> command is used to calibrate the correction gain constants for a given scanning card. The channel gain value is necessary in order for the internal firmware to accurately interpret readings coming from the input channels. This command will take the parameters chan and type and will calculate the gain based on the present channel input voltage.</p> <p>For more information on manual calibration, see chapter <i>System Calibration</i>.</p> <p>Note: To achieve correct results, this command must be issued twice. First, with a negative input voltage and next, with a positive input voltage. Each time the command has been issued, the precision voltage source must remain at its value until the <i>TRIGGER</i> LED indicator stops flashing.</p>		
EXAMPLE		
PRINT#1, "OUTPUT07;K12345X"	' Enter <i>Calibration Mode</i>	
PRINT#1, "OUTPUT07;G524,1"	' Apply negative precision voltage	
	' Calculate negative gain for thermocouple card on slave card 16 (TempScan/1100)	
	' Wait for command to complete	
PRINT#1, "OUTPUT07;G524,1"	' Apply positive precision voltage	
	' Calculate positive gain for thermocouple card on slave card 16 (TempScan/1100)	
	' Wait for command to complete	
	' Remove precision voltage	
PRINT#1, "OUTPUT07;EX"	' End <i>Calibration Mode</i>	

H - Calibrate Channel Offset

TYPE	Calibration	
EXECUTION	Immediate	
SYNTAX	Hchan	Calibrate the correction offset constants for given option card where chan is the channel number such that $1 \leq \text{chan} \leq \text{max}$, where max = 992 for the TempScan/1100 and max = 744 for the MultiScan/1200. The chassis is chan = 0.
DESCRIPTION		
<p>Note: This command is only for advanced users who perform their own calibration. It is not necessary for normal, everyday operation.</p> <p>Active only in <i>Calibration Mode</i>, the <i>Calibrate Channel Offset (H)</i> command is used to calibrate the correction offset constants for a given scanning card. The channel offset values are necessary in order for the internal firmware to accurately interpret readings coming from the input channels. This command will take the parameter chan and calculate the offsets based on the present channel input voltage.</p> <p>For more information on manual calibration, see chapter <i>System Calibration</i>.</p> <p>Note: To achieve correct results, a short must be connected across the desired channel before performing this command. After the command has been issued, the precision voltage source must remain at its value at least until the <i>TRIGGER</i> LED indicator stops flashing.</p>		
EXAMPLE		
<pre>PRINT#1, "OUTPUT07;K12345X" ' Enter Calibration Mode ' Connect short across the desired channel PRINT#1, "OUTPUT07;H524X" ' Calculate offsets for slave card 16 (TempScan/1100) ' Wait for command to complete ' Remove precision voltage PRINT#1, "OUTPUT07;EX" ' End Calibration Mode</pre>		

I - Set Scan Interval

TYPE	Acquisition	
EXECUTION	Deferred	
SYNTAX	Inorm, acq	Set the two configurable scan intervals of the unit where norm and acq are the normal and acquisition scan intervals which have the form: hh:mm:ss.t where hh is hours, mm is minutes, ss is seconds, and t is tenths of a second.
	I?	Query scan interval selection.
DESCRIPTION		
<p>The <i>Set Scan Interval (I)</i> command is used to set the following two types of scan intervals:</p> <ul style="list-style-type: none"> • Normal Scan Interval. The <i>normal</i> scan interval is used when the TempScan/1100 or MultiScan/1200 unit is acquiring scans before the <i>Trigger</i> (trigger start event) has occurred, or after the <i>Stop</i> (trigger stop event) has occurred. These two scanning regions are called the <i>Pre-Trigger</i> scan and the <i>Post-Stop</i> scan, respectively. • Acquisition Scan Interval. The <i>acquisition</i> scan interval is used when the TempScan/1100 or MultiScan/1200 unit is acquiring scans after the <i>Trigger</i> (trigger start event) has occurred, but before the <i>Stop</i> (trigger stop event) has occurred. This middle scanning region is called the <i>Post-Trigger</i> scan. <p>The norm and acq arguments represent the <i>normal</i> and <i>acquisition</i> scan intervals, respectively.</p> <p>The scan interval can also be set to run at the <i>minimum scan interval</i>, yielding the fastest scan rate that the current system configuration will allow. This is referred to as <i>fast mode</i>. Either the <i>normal</i> or <i>acquisition scan interval</i> can be set to <i>fast mode</i>, by specifying the following scan interval – 00:00:00.0 – in the I command.</p> <p>When the I command is interrogated by the unit, the unit will determine, by examining its current channel configuration, if it is capable of running at the desired interval. If the unit determines that it is not capable of running at the desired interval, it will automatically default to <i>fast mode</i> for the interval(s) in question. It will also issue a Command Conflict Error to inform you that it is not running at the user-specified interval.</p> <p>The scan interval can be programmed from a 24-hour period to a 0.1-second period in increments of 0.1 second. In addition to setting the scan interval to zero, if the scan interval is programmed for a value less than the unit is capable of running at, the unit will also default to <i>fast mode</i>.</p> <p>For more information on scan intervals, see section <i>Scan Configuration</i> in the chapter <i>System Configuration</i>.</p>		
EXAMPLE		
<pre>PRINT#1, OUTPUT07;I01:00:00.0, 00:00:00.0X ' Set normal scan interval to once every hour and acquisition scan interval to fast mode PRINT#1, OUTPUT07;I?X ' Query the current scan intervals PRINT#1, ENTER07 LINE INPUT #2, I\$ PRINT I\$ ' Screen shows the current scan intervals I01:00:00.0,00:00:00.0</pre>		

I# - Set Digital Input Stamping

TYPE	System	
EXECUTION	Deferred	
SYNTAX	I#state	Specify whether or not digital input stamping will be enabled. Valid options for state are: 0 - Disable digital input stamping (default), and 1 - Enable digital input stamping.
DESCRIPTION		
<p>The <i>Set Digital Input Stamping (I#)</i> command, when enabled, is used to stamp the digital input states of the 8 digital inputs to the end of each scan as the scans occur in real time. The digital input status consists of 16 bits, grouped into two 8-bit bytes: Bits 07-00 and 15-08, where Bits 15-08 are always inactive. Consequently, each of the 8 Bits 07-00 is identified with a 1 signifying input on, or a 0 signifying input off, while each of the 8 Bits 15-08 is identified with a 0 (off).</p> <p>In the following data formats, the digital input status will be stamped to each scan in the corresponding patterns:</p> <ul style="list-style-type: none"> • Binary Low-High-Byte format: Two 8-bit Bytes 1 and 2, where: <ul style="list-style-type: none"> Byte 1: Bits 07 through 00. Byte 2: Bits 15 through 08. • Binary High-Low-Byte format: Two 8-bit Bytes 1 and 2, where: <ul style="list-style-type: none"> Byte 1: Bits 15 through 08. Byte 2: Bits 07 through 00. • ASCII format: Two 8-bit bytes in Binary format converted to eight bytes in printable ASCII format: <ul style="list-style-type: none"> TxxxT000, where: T = User terminator. xxx = Three-digit decimal value of Bits 07 through 00. <p>For more information on digital input stamping, see section <i>Stamping Configuration</i> in the section <i>System Configuration</i>.</p> <p>Note: In an 8-bit byte, Bits 00 through 07 correspond to digital input/output (DIO) lines 1 through 8. Also, Bit <i>n</i> corresponds to the decimal value 2^n (where <i>n</i> is an integer from 00 to 07).</p> <p>Note: If scan alarm stamping has also been enabled via the <i>Set Scan Alarm Stamping (A#)</i> command, then the digital input states will be stamped after the scan alarm output states have been stamped.</p> <p>Note: Data in Binary format is not printable. The Binary data must be converted to ASCII format for printability.</p>		
EXAMPLE		
<pre>PRINT#1, "OUTPUT07;I#1X" ' Enable digital input stamping PRINT#1, "OUTPUT07;I#0X" ' Disable digital input stamping</pre>		

J - Calibrate Cold Junction Offset

TYPE	Calibration	
EXECUTION	Immediate	
SYNTAX	Jchan, type, temp	Calibrate the cold-junction offsets for cold-junction compensation of the thermocouple signals where chan is the channel number such that $1 \leq \text{chan} \leq \text{max}$, where max = 992 for the TempScan/1100 and max = 744 for the MultiScan/1200. type is the thermocouple channel type. temp is the reference temperature currently being applied to the selected channel, with the form nnn.n in degrees ° C.
DESCRIPTION		
<p>Note: This command is only for advanced users who perform their own calibration. It is not necessary for normal, everyday operation.</p> <p>Active only in <i>Calibration Mode</i>, the <i>Calibrate Cold Junction Offset (J)</i> command is used to calibrate the cold junction offsets for cold-junction compensation of the thermocouple signals. Each thermocouple input channel has associated with it one of these temperature sensors. Although calibrated at the factory, these temperature sensors are subject to component aging which may affect their accuracy over time. The function of the J command is to allow the adjusting of the internal firmware to compensate for the affects of component aging.</p> <p>Since there are 4 cold junction temperature sensors associated with 32 temperature input channels, it is necessary to select 4 channels. Each channel is associated with one of the 4 cold junction temperature sensors in order to calibrate all cold junction temperature sensors on a given card.</p> <p>For more information on manual calibration, see chapter <i>System Calibration</i>.</p> <p>Note: To achieve correct results, four separate channels on each card must be supplied with an accurate thermocouple signal of known warm junction temperature before performing this command. After the command has been issued, the applied thermocouple signal must remain at its value until the <i>TRIGGER</i> LED indicator stops flashing.</p> <p>Note: The parameter type is the same channel type that is used with the <i>Configure Channels (C)</i> command.</p>		
EXAMPLE		
<pre> PRINT#1, "OUTPUT07;K12345X" ' Enter Calibration Mode ' Apply precision temperature PRINT#1, "OUTPUT07;J812,2,101.7X" ' Compute cold junction offset for the temperature ' sensor associated with the type K thermocouple ' on channel 1 of slave card 25 at 101.7°C ' Wait for command to complete PRINT#1, "OUTPUT07;EX" ' Remove precision temperature ' End Calibration Mode </pre>		

K - Enter Calibration Mode

TYPE	Calibration	
EXECUTION	Immediate	
SYNTAX	Kkey	Enter <i>Calibration Mode</i> if the keyword (or password) is correct, where key is the keyword in the form of a 5-digit number nnnnn . Therefore the password can be no longer than 5 characters.
	K?	Query Kkey as defined above.
DESCRIPTION		
<p>Note: This command is only for advanced users who perform their own calibration. It is not necessary for normal, everyday operation.</p> <p>The <i>Enter Calibration Mode</i> (K) command places the unit into <i>Calibration Mode</i>. While in <i>Calibration Mode</i> the unit may be calibrated using any of the defined calibration commands. In addition, all other commands are valid during <i>Calibration Mode</i>. However, if the unit is not in <i>Calibration Mode</i>, none of the defined calibration commands are valid, and an error condition will be generated if any of these commands are issued.</p> <p>The K command requires a pre-defined keyword as a parameter. This keyword must match the existing keyword definition in order to enter <i>Calibration Mode</i>. If the keyword is not correct, <i>Calibration Mode</i> will not be entered and no calibration commands will be processed.</p> <p>For more information on manual calibration, see chapter <i>System Calibration</i>.</p> <p>Note: If the keyword becomes lost or forgotten a new keyword can be issued with the <i>Change Calibration Keyword</i> (*K) command.</p>		
EXAMPLE		
<pre> PRINT#1, "OUTPUT07;K12345X" ' Enter Calibration Mode with the keyword 12345 PRINT#1, "OUTPUT07;U2X" ' Check for keyword error PRINT#1, "ENTER07" INPUT#2, C% ' Get the Calibration Status Register (CSR) IF (C% AND 16) THEN ' Check for a keyword error PRINT,"ERROR - INVALID KEYWORD" HALT ' If there is an error, stop execution ENDIF ' Connect short across desired channel PRINT#1, "OUTPUT10;H524X" ' Calculate offset for slave card 16 (TempScan/1100) ' Wait for command to complete ' Wait until TRIGGER LED indicator stops flashing ' Apply negative precision voltage PRINT#1, "OUTPUT10;G524,1X" ' Calculate negative gain for slave card 16 ' (TempScan/1100) ' Wait for command to complete ' Apply positive precision voltage PRINT#1, "OUTPUT10;G524,1X" ' Calculate positive gain for slave card 16 ' (TempScan/1100) ' Wait for command to complete ' Remove precision voltage PRINT#1, "EX" ' End Calibration Mode </pre>		

L - Set Trigger Level

TYPE	Channel	
EXECUTION	Deferred	
SYNTAX	Lchan, level, hyst	Sets the level against which the testing of channel readings should be performed where chan is the channel number such that $1 \leq \text{chan} \leq \text{max}$, where max = 992 for the TempScan/1100 and max = 744 for the MultiScan/1200. level is the level against which the readings are tested to determine if the level has been exceeded. hyst is the hysteresis level.
	L?	Query the current level settings
DESCRIPTION		
<p>The <i>Set Trigger Level (L)</i> command simply sets the level against which the testing of channel readings should be performed. The <i>Set Trigger Configuration (T)</i> command should be used to configure whether the level condition should be tested for going above the specified level or below the specified level.</p> <p>The parameter level is the value, which, if exceeded by going above or below it as defined, generates a <i>Trigger</i> (trigger start event) or <i>Stop</i> (trigger stop event). The parameter hyst is the hysteresis value that, with level, is used to test whether the level condition still persists. The level condition will persist until the channel readings no longer exceed the level as specified. Further, in order to come out of the level condition, the channel readings must retreat from the exceeded level value by the amount of the hysteresis value. The temperature and volts format for the level and hyst arguments follow the rules defined under the <i>Set Data Format (F)</i> command and in the section <i>Data Format Configuration</i> in the chapter <i>System Configuration</i>.</p> <p>Note: The <i>Set Trigger Level (L)</i> command is only valid for <i>Trigger</i> Types 4 and 5, as defined by the <i>Set Trigger Configuration (T)</i> command.</p>		
EXAMPLE		
<pre>PRINT#1, "OUTPUT07;F0,0X" ' Set the Engineering Units format to be degrees C PRINT#1, "OUTPUT07;L1,100.0,10.0X" ' Set the level channel to be Channel 1 at a level 100.0 °C with a hysteresis of 10.0 °C PRINT#1, "OUTPUT07;L?X" ' Read the current level setting PRINT#1, "ENTER07" LINE INPUT #2, L\$ PRINT L\$ ' The screen shows the current level settings L001,+0100.0,+0010.0 PRINT#1, "OUTPUT07;T4,5,0,0X" ' Set the <i>Trigger</i> on channel going above the level and set the <i>Stop</i> on the channel going below the level</pre>		

L# - Set Scan Rate

TempScan/1100 only		
TYPE	System	
EXECUTION	Deferred	
SYNTAX	L#rate	Specify whether to select the optional slow scan rate or to select the default fast scan. Valid options for rate are: 0 - Select fast scan rate (default), and 1 - Select slow scan rate.
DESCRIPTION		
<p>Although the TempScan/1100 factory default setting is <i>fast scan rate</i>, the <i>Set Scan Rate (L#)</i> command can program the scan rate to be reduced by a factor of 4 (from 16 readings per line cycle to 4 readings per line cycle). This <i>slow scan rate</i> feature allows for increased settling time when measuring signals with long wire lengths. Using this L# command, the fast scan rate can also be reinstated.</p>		
EXAMPLE		
<pre>PRINT#1, "OUTPUT07;L#0X" ' Select fast scan rate PRINT#1, "OUTPUT07;L#1X" ' Select slow scan rate</pre>		

M - Set SRQ Mask

TYPE	System	
EXECUTION	Deferred	
SYNTAX	Mmask	Use the IEEE 488 Service Request (SRQ) mechanism to inform the IEEE 488 controller of certain conditions, where mask is in the form of the number nnn such that $000 \leq nnn \leq 255$ is summed from the following conditions: <div style="display: flex; justify-content: space-between; margin-top: 5px;"> <div style="width: 45%;"> <p>128 – SRQ on Buffer Overrun</p> <p>032 – SRQ on Event Detected</p> <p>016 – SRQ on Message Available</p> <p>008 – SRQ on Scan Available</p> </div> <div style="width: 45%;"> <p>004 – SRQ on Ready</p> <p>002 – SRQ on Trigger Event</p> <p>001 – SRQ on Alarm</p> <p>000 – Clear SRQ Mask</p> </div> </div>
	M?	Query the SRQ mask.
DESCRIPTION		
<p>The <i>Set SRQ Mask (M)</i> command uses the IEEE 488 Service Request (SRQ) mechanism to inform the IEEE 488 bus controller of the existence of several conditions in the Service Request Enable Register (SRE). The bits in the SRE represent an exact image of the bits in the Status Byte Register (STB) except for the Request for Service Bit (RQS, Bit 6) or Master Summary Status Bit (MSS, Bit 6). When a condition is set in the STB, its image bit is checked in the SRE. If the image bit is enabled, the unit will generate a Service Request (SRQ).</p> <p>Multiple conditions can be enabled simultaneously. If multiple conditions are contained within the same command string, each <i>Set SRQ Mask (M)</i> command should be followed by the <i>Execute (X)</i> command. Otherwise, since the resulting SRQ Mask register value is the logical <i>OR</i>ed value, or sum, of the individual values sent, the entire summed value of all the desired conditions may be sent within one <i>Set SRQ Mask (M)</i> command. The programmed SRQ Mask remains enabled until it is cleared by the receipt of a M000 command, the receipt of a <i>Reset Power-On (*R)</i> command, or the detection of a Device Clear (DCL) or Selected Device Clear (SDC).</p> <p>The following list outlines the possible conditions of the Service Request Enable Register (SRE), as reflected in the Status Byte Register (STB).</p> <ul style="list-style-type: none"> • M128: SRQ on Buffer Overrun (SRE Bit 7). Sending this command will cause the unit to generate a Service Request when it has detected that an overrun of the Acquisition Buffer has occurred. • M032: SRQ on Event Detected (SRE Bit 5). Sending this command will cause the unit to generate a Service Request when at least one of the defined events in the Event Status Register (ESR) has occurred. • M016: SRQ on Message Available (SRE Bit 4). Sending this command will cause the unit to generate a Service Request when there is data available in the output queue to be read. • M008: SRQ on Scan Available (SRE Bit 3). Sending this command will cause the unit to generate a Service Request when at least one acquisition scan is available in the Acquisition Buffer to be read. • M004: SRQ on Ready (SRE Bit 2). Sending this command will cause the unit to generate a Service Request when the unit has completed executing a set of commands and is ready to process another command from the IEEE 488 bus controller. • M002: SRQ on Trigger Event (SRE Bit 1). Sending this command will cause the unit to generate a Service Request when it has detected a valid <i>Trigger</i> (trigger start event) or <i>Stop</i> (trigger stop event) from the programmed trigger source. • M001: SRQ on Alarm (SRE Bit 0). Sending this command will cause the unit to generate a Service Request when it has detected a valid alarm condition. • M000: This is the power-on default mask value. Sending this command disables the unit from generating Service Requests by clearing the entire mask of the Service Request Enable Register (SRE) to zero. <p>For more information, see section <i>Status-Reporting & Mask Registers</i> in the chapter <i>System Operation</i>.</p>		
EXAMPLE		
<pre>PRINT#1, "OUTPUT07;M0X" ' Clear the Service Request Enable Register (SRE) PRINT#1, "OUTPUT07;M3X" ' Set the unit to SRQ on Alarm or Trigger (003 = 002 + 001)</pre>		

M# - Set Measuring Mode

MultiScan/1200 only		
TYPE	System	
EXECUTION	Deferred	
SYNTAX	M#mode	Specify measuring mode. Valid options for mode are: 0 - Line-cycle integration / high-speed multi-channel mode, and 1 - Single-channel high-speed burst mode.
DESCRIPTION		
<p>The <i>Set Measuring Mode (M#)</i> command selects one of the two basic internal measuring modes supported by the MultiScan/1200 unit:</p> <ul style="list-style-type: none"> • Line-Cycle Integration / High-Speed Multi-Channel (or Default) Mode. In the line-cycle integration / high-speed multi-channel mode, the MultiScan/1200 samples channel data at 1.92 kHz or once every 520.83 μs. You can select the number of samples over which to average in order to accomplish noise filtering. • Single-Channel High-Speed Burst Mode. In the single-channel burst mode, the MultiScan/1200 collects data in user-defined multiples of 256 samples at a user-defined sampling frequency between 38.5 Hz and 20.0 kHz. <p>For more information on MultiScan/1200 measuring mode parameters, see section <i>Measuring Modes (MultiScan/1200 Only)</i> in the chapter <i>System Configuration</i>, and see commands <i>Set Burst Mode Frequency (F#)</i> and <i>Set Averaging Weight (W#)</i>.</p>		
EXAMPLES		
PRINT#1, "OUTPUT07;M#0X"	' Select Line Cycle Integration/High-Speed Multi-Channel Mode	
PRINT#1, "OUTPUT07;W#32X"	' Select number of samples = 32	
PRINT#1, "OUTPUT07;Y0,10,0X"	' Setup to read 10 <i>Post-Trigger</i> scans	
PRINT#1, "OUTPUT07;C1-3,1X"	' Enable Channels 1 - 3 for thermocouples Type J	
PRINT#1, "OUTPUT07;T1,8,0,0X"	' Arm the unit	
PRINT#1, "OUTPUT07;@X"	' Trigger unit and collect scans	
PRINT#1, "OUTPUT07;M#1X"	' Select Single Channel High-Speed Burst Mode	
PRINT#1, "OUTPUT07;F#10000.0X"	' Set sampling frequency = 10 KHz	
PRINT#1, "OUTPUT07;Y0,4096,0X"	' Set count to take a 1.0-megabyte amount of samples	
PRINT#1, "OUTPUT07;C1,26X"	' Select Channel 1 for reading 250 Volts AC samples	
PRINT#1, "OUTPUT07;T1,8,0,0X"	' Arm the unit	
PRINT#1, "OUTPUT07;@X"	' Trigger unit and collect scans	

N - Set Event Mask

TYPE	System											
EXECUTION	Deferred											
SYNTAX	Nmask	<p>Directly sets the Event Status Enable Register (ESE) where mask is in the form of the number nnn such that $000 \leq nnn \leq 255$ is summed from the following conditions:</p> <table style="width: 100%; border: none;"> <tr> <td style="width: 50%;">128 – ESB on Power On</td> <td style="width: 50%;">004 – ESB on Query Error</td> </tr> <tr> <td>064 – ESB on Buffer 75% Full</td> <td>002 – ESB on Stop Event</td> </tr> <tr> <td>032 – ESB on Command Error</td> <td>001 – ESB on Acquisition complete</td> </tr> <tr> <td>016 – ESB on Execution Error</td> <td>000 – ESB on Clear Event Mask</td> </tr> <tr> <td>008 – ESB on Device Dependent Error</td> <td></td> </tr> </table>	128 – ESB on Power On	004 – ESB on Query Error	064 – ESB on Buffer 75% Full	002 – ESB on Stop Event	032 – ESB on Command Error	001 – ESB on Acquisition complete	016 – ESB on Execution Error	000 – ESB on Clear Event Mask	008 – ESB on Device Dependent Error	
	128 – ESB on Power On	004 – ESB on Query Error										
064 – ESB on Buffer 75% Full	002 – ESB on Stop Event											
032 – ESB on Command Error	001 – ESB on Acquisition complete											
016 – ESB on Execution Error	000 – ESB on Clear Event Mask											
008 – ESB on Device Dependent Error												
N?	Query the Event mask.											
DESCRIPTION												
<p>The <i>Set Event Mask (N)</i> command directly sets the Event Status Enable Register (ESE) which in turn, determines which Event Status Register (ESR) conditions are enabled to generate the Event Status Register Bit (ESR Bit 5 or ESB) in the Status Byte Register (STB). The bits in the ESE represent an exact image of the bits in the ESR. When a condition is set in the ESR, its image bit is checked in the ESE. If any image bits are enabled, the bits in the ESR will be mapped into the ESR Bit 5 (or ESB) in the STB.</p> <p>Multiple conditions can be enabled simultaneously. If multiple conditions are contained within the same command string, each <i>Set Event Mask (N)</i> command should be followed by the <i>Execute (X)</i> command. Otherwise, since the resulting Event Mask register value is the logical <i>ORed</i> value, or sum, of the individual values sent, the entire summed value of all the desired conditions may be sent within one <i>Set Event Mask (N)</i> command. The programmed Event Mask remains enabled until it is cleared by the receipt of a N000 command, or the receipt of a <i>Reset Power-On (*R)</i> command.</p> <p>The following list outlines the possible conditions of the Event Status Enable Register (ESE), as reflected in the Event Status Register (ESR):</p> <ul style="list-style-type: none"> • N128: ESB on Power On (ESE Bit 7). Sending this command will allow the setting of the ESB when the unit is first powered up or when the <i>Reset Power-On (*R)</i> command is issued. • N064: ESB on Buffer 75% Full (ESE Bit 6). Sending this command will allow the setting of the ESB when the Acquisition Buffer has been filled to at least 75% of its capacity. • N032: ESB on Command Error (ESE Bit 5). Sending this command will allow the setting of the ESB when an illegal command or command syntax error is detected. • N016: ESB on Execution Error (ESE Bit 4). Sending this command will allow the setting of the ESB when one of several errors has occurred during the execution of a command. • N008: ESB on Device Dependent Error (ESE Bit 3). Sending this command will allow the setting of the ESB when a conflict error has occurred. A conflict error is generated when a command cannot execute correctly because it would interfere with other commands or settings. • N004: ESB on Query Error (ESE Bit 2). Sending this command will allow the setting of the ESB when the controller has attempted to read from the output queue when no response is present or pending, or when a response has been lost. Data may be lost when too much data is requested to be buffered in the queue, where the controller has sent a new query before reading the response to a prior query. • N002: ESB on Stop Event (ESE Bit 1). Sending this command will allow the setting of the ESB when the user-defined <i>Stop</i> (trigger stop event) of a configured acquisition has been satisfied. • N001: ESB on Acquisition Complete (ESE Bit 0). Sending this command will allow the setting of the ESB when the acquisition operation has been completed. • N000: This is the power-on default mask value. Sending this command clears the entire mask of the Event Status Enable (ESE) Register to zero. <p>For more information, see section <i>Status-Reporting & Mask Registers</i> in the chapter <i>System Operation</i>.</p>												
EXAMPLE												
<pre>PRINT#1, "OUTPUT07;N0X" ' Clear the Event Status Enable Register (ESE) PRINT#1, "OUTPUT07;N3X" ' Enable ESB on detection of Stop Event or Acquisition Complete (003 = 002 + 001)</pre>												

O - Set Digital Outputs

TYPE	System																																																																	
EXECUTION	Immediate																																																																	
SYNTAX	O bank1, bank2, bank3, bank4	Set any of the 32 digital outputs, grouped into four 8-bit banks, to a specified setting, where bankn (for n = 1, 2, 3, 4) is an argument in the form of the number nnn such that 000 ≤ nnn ≤ 255 when converted to binary format represents the desired settings for the 8-bit bank.																																																																
	O?	Query current state of digital output.																																																																
DESCRIPTION																																																																		
<p>Located on the TempScan/1100 or MultiScan/1200 rear panel, the DB50 digital I/O connector provides eight (8) digital input lines and thirty-two (32) digital output lines. The <i>Set Digital Outputs</i> (O) command allows you to force any of the 32 digital outputs, grouped into four 8-bit banks, to a specific setting. For each digital output, you can specify whether the bit should be cleared with a 0 (active low, logic false) or set with a 1 (active high, logic true).</p> <p>The <i>Set Digital Outputs</i> (O) command will override the current alarm output status as set via the <i>Assign Alarm Output</i> (A) command. However, if it is desired not to affect a certain bank (for example, to preserve the alarm output states), a value of 999 can be used for the argument for that bank. This will effectively "mask off" that bank from being updated.</p> <p>The Bank to Digital Output mapping is as follows:</p> <ul style="list-style-type: none"> Bank 1 (Byte 1): Digital Outputs (Bits) 07 through 00. Bank 2 (Byte 2): Digital Outputs (Bits) 15 through 08. Bank 3 (Byte 3): Digital Outputs (Bits) 23 through 16. Bank 4 (Byte 4): Digital Outputs (Bits) 31 through 24. <p>Each argument bankn represents the desired bitmapping for the corresponding bank of digital outputs. The argument is a decimal number, which, when converted to binary format, represents the desired settings for that bank of digital outputs. For example, an argument of 201 for bank2 would be interpreted in binary as 11001001 as follows:</p>																																																																		
<table border="1" style="width: 100%; border-collapse: collapse; text-align: center;"> <tr> <td style="width: 15%;">Argument</td> <td colspan="8">201 = 128 + 64 + 8 + 1</td> </tr> <tr> <td>Decimal Values</td> <td>128</td> <td>64</td> <td>0</td> <td>0</td> <td>8</td> <td>0</td> <td>0</td> <td>1</td> </tr> <tr> <td>Active High/Low</td> <td>High</td> <td>High</td> <td>Low</td> <td>Low</td> <td>High</td> <td>Low</td> <td>Low</td> <td>High</td> </tr> <tr> <td>Logical Value</td> <td>1</td> <td>1</td> <td>0</td> <td>0</td> <td>1</td> <td>0</td> <td>0</td> <td>1</td> </tr> <tr> <td>Bit</td> <td>15</td> <td>14</td> <td>13</td> <td>12</td> <td>11</td> <td>10</td> <td>09</td> <td>08</td> </tr> <tr> <td>Digital I/O Line</td> <td>16</td> <td>15</td> <td>14</td> <td>13</td> <td>12</td> <td>11</td> <td>10</td> <td>09</td> </tr> <tr> <td>Digital Outputs</td> <td colspan="8">Digital Outputs Lines 16, 15, 12 and 09 are set.</td> </tr> </table>				Argument	201 = 128 + 64 + 8 + 1								Decimal Values	128	64	0	0	8	0	0	1	Active High/Low	High	High	Low	Low	High	Low	Low	High	Logical Value	1	1	0	0	1	0	0	1	Bit	15	14	13	12	11	10	09	08	Digital I/O Line	16	15	14	13	12	11	10	09	Digital Outputs	Digital Outputs Lines 16, 15, 12 and 09 are set.							
Argument	201 = 128 + 64 + 8 + 1																																																																	
Decimal Values	128	64	0	0	8	0	0	1																																																										
Active High/Low	High	High	Low	Low	High	Low	Low	High																																																										
Logical Value	1	1	0	0	1	0	0	1																																																										
Bit	15	14	13	12	11	10	09	08																																																										
Digital I/O Line	16	15	14	13	12	11	10	09																																																										
Digital Outputs	Digital Outputs Lines 16, 15, 12 and 09 are set.																																																																	
<p>For more information on digital outputs, see section <i>Digital I/O Configuration</i> in the chapter <i>TempScan/1100 & MultiScan/1200</i>, or see section <i>Digital I/O Configuration</i> in the chapter <i>System Configuration</i>.</p> <p>Note: In an 8-bit byte, Bits 00 through 07 correspond to digital input/output (DIO) lines 1 through 8. Also, Bit <i>n</i> corresponds to the decimal value 2^n (where <i>n</i> is an integer from 00 to 07).</p>																																																																		
EXAMPLE																																																																		
<pre>PRINT#1, "OUTPUT07;O?X" ' Get the current state of the digital output banks PRINT#1, "ENTER07" LINE INPUT #2, N\$ PRINT N\$ ' Screen shows the current state of the banks 0128,255,065,024 PRINT#1, "OUTPUT07;O000,999,076,234X" ' Set Banks 1, 3, and 4 PRINT#1, "OUTPUT07;O?X" ' Get the new state of the digital output banks PRINT#1, "ENTER07" LINE INPUT #2, O\$ PRINT O\$ ' Screen shows the new state of the banks 0000,255,076,234 ' Note that Bank 2 did not change</pre>																																																																		

P - Program Trigger Times

TYPE	Channel	
EXECUTION	Deferred	
SYNTAX	Pstart, stop	Set the <i>Trigger</i> and/or <i>Stop</i> times for an acquisition configured for start and/or stop on absolute time, where start and stop are in the standard Time/Date input format: hh:mm:ss:t,MM/DD/YY where hh is in hours, mm is in minutes, ss is in seconds, t is in tenths of a second, MM is the month, DD is the day, and YY is the year.
	P?	Query current start and stop times in the form: Pstart, stop
DESCRIPTION		
<p>The <i>Program Trigger Times</i> (P) command is used to specify the <i>Trigger</i> (trigger start event) and/or <i>Stop</i> (trigger stop event) times for an acquisition that is configured for a start and/or stop on absolute time, as set via the <i>Set Trigger Configuration</i> (T) command. If only the start time is needed, the stop argument should be set to 00:00:00.0,00/00/00. Likewise, if only the stop time is needed, the start argument should be set to 00:00:00.0,00/00/00.</p> <p>In addition to the ability to start/stop on a particular Time/Date, the unit has the ability to start/stop at a particular Time, independent of the Date. If the Date for the start/stop Time is of no concern, then the Date portion of the Time/Date field should be set to 00/00/00. In this way, the unit can start or stop an acquisition at a particular Time regardless of the Date. This feature is particularly useful when using the <i>Auto Re-arm</i> feature of the unit where, for example, data can be collected at a particular time each day for a number of days without user intervention.</p>		
EXAMPLE		
<pre>PRINT#1, "OUTPUT07;S12:54:00.0,01/01/98X" ' Set the internal real-time clock of the unit PRINT#1, "OUTPUT07;P01:00:00.0,01/01/98, ' Set start (1:00 am) and stop (2:00 am) 02:00:00.0,01/01/98X" acquisition times PRINT#1, "OUTPUT07;T11,11,0,0X" ' Configure for start/stop on absolute time</pre>		

Q - Set Query Terminator

TYPE	System																																															
EXECUTION	Deferred																																															
SYNTAX	Qresp, h11, scan, block, sep	Set the query terminators via the following parameters: resp is the response terminator, h11 is the channel terminator, scan is the scan terminator, and block is the <i>Trigger Block</i> terminator. sep is the separator terminator which determines whether or not a separator character should be used. Valid options for sep are: 0 - Place no separators in returned buffered scan data when it is read, and 1 - Place a separator whose value is determined by the current <i>Set User Terminator (V)</i> command setting into the returned buffer data when it is read.																																														
	Q?	Query current terminator settings.																																														
DESCRIPTION																																																
<p>The <i>Set Query Terminator (Q)</i> command is used to set the data output terminators via the following parameters – resp, h11, scan, block, and sep. Each of the first four arguments may be defined with one of the following terminator types, where USER is the user-defined User Terminator corresponding to the ASCII decimal value val, as defined by the <i>Set User Terminator (V)</i> command:</p> <table border="1" style="width: 100%; border-collapse: collapse; margin: 10px 0;"> <thead> <tr> <th rowspan="2">Terminator Type</th> <th colspan="2">Terminator Description</th> <th rowspan="2">Terminator Type</th> <th colspan="2">Terminator Description</th> </tr> <tr> <th>IEEE-488</th> <th>Serial</th> <th>IEEE-488</th> <th>Serial</th> </tr> </thead> <tbody> <tr> <td>0</td> <td>(None)</td> <td>(None)</td> <td></td> <td></td> <td></td> </tr> <tr> <td>1</td> <td>CR LF/EOI</td> <td>CR LF</td> <td>6</td> <td>CR</td> <td>CR</td> </tr> <tr> <td>2</td> <td>CR LF</td> <td>CR LF</td> <td>7</td> <td>LF/EOI</td> <td>LF</td> </tr> <tr> <td>3</td> <td>LF CR/EOI</td> <td>LF CR</td> <td>8</td> <td>LF</td> <td>LF</td> </tr> <tr> <td>4</td> <td>LF CR</td> <td>LF CR</td> <td>9</td> <td>USER/EOI</td> <td>USER</td> </tr> <tr> <td>5</td> <td>CR/EOI</td> <td>CR</td> <td>10</td> <td>USER</td> <td>USER</td> </tr> </tbody> </table> <p>The first argument resp specifies the response terminator for general purpose queries which do not request High/Low/Last or Acquisition Buffer data. The second argument h11 specifies the channel terminator to be used for High/Low/Last (HLL) Registers query requests. The third argument scan specifies the terminator which will follow each scan that is output for Acquisition Buffer query requests, except when following the last scan in the <i>Trigger Block</i>. In this case, the next argument block specifies the terminator which will follow each <i>Trigger Block</i>. The last argument sep specifies whether or not a reading separator character should be placed between each returned reading in the Acquisition Buffer scan data. Like the USER terminator, this separator is a user-defined User Terminator with the ASCII decimal value val, set via the <i>Set User Terminator (V)</i> command.</p> <p>For more information on terminators, see section <i>Data Format Configuration</i> in the chapter <i>System Configuration</i>.</p>			Terminator Type	Terminator Description		Terminator Type	Terminator Description		IEEE-488	Serial	IEEE-488	Serial	0	(None)	(None)				1	CR LF/EOI	CR LF	6	CR	CR	2	CR LF	CR LF	7	LF/EOI	LF	3	LF CR/EOI	LF CR	8	LF	LF	4	LF CR	LF CR	9	USER/EOI	USER	5	CR/EOI	CR	10	USER	USER
Terminator Type	Terminator Description			Terminator Type	Terminator Description																																											
	IEEE-488	Serial	IEEE-488		Serial																																											
0	(None)	(None)																																														
1	CR LF/EOI	CR LF	6	CR	CR																																											
2	CR LF	CR LF	7	LF/EOI	LF																																											
3	LF CR/EOI	LF CR	8	LF	LF																																											
4	LF CR	LF CR	9	USER/EOI	USER																																											
5	CR/EOI	CR	10	USER	USER																																											
EXAMPLE																																																
<pre> PRINT#1, "OUTPUT07;C1-2,1X" PRINT#1, "OUTPUT07;F0,0X" PRINT#1, "OUTPUT07;Q7,7,0,0,0X" PRINT#1, "OUTPUT07;Q?X" PRINT#1, "ENTER07" Q07,07,00,00,00 PRINT#1, "OUTPUT07;U13X" PRINT#1, "ENTER07" INPUT#1 A\$ +0104.20 PRINT#1, "ENTER07" INPUT#1 A\$ +0010.40 PRINT#1, "OUTPUT07;Q7,0,0,0,0X" PRINT#1, "OUTPUT07;U13X" PRINT#1, "ENTER07" INPUT#1 A\$ +0104.20 +0010.40 </pre>	<ul style="list-style-type: none"> ‘ Configure two channels for Type J thermocouples ‘ Configure Engineering Units, degrees C ‘ Set the resp and h11 terminators to LF/EOI ‘ Get the current query terminators ‘ Screen shows the current query terminators ‘ Request the last readings ‘ Get reading for Channel 1 ‘ Screen shows reading ‘ Get reading for Channel 2 ‘ Screen shows reading ‘ Now set the resp terminator only to LF/EOI ‘ Request the last readings ‘ Get readings for Channels 1 through 4 ‘ Screen shows readings for Channels 1 and 2 together, instead of one at a time 																																															

QC? - Query Card Data

TYPE	Calibration																						
EXECUTION	Immediate																						
SYNTAX	QC?	Read back the card identification and calibration information from the scanning card previously selected by the <i>Select Card (C#)</i> command.																					
DESCRIPTION																							
<p>Note: This command is only for advanced users who perform their own calibration. It is not necessary for normal, everyday operation.</p> <p>The <i>Query Card Data (QC?)</i> command is used to read back the card identification and calibration information from the scanning card previously selected by the <i>Select Card (C#)</i> command. When this command is issued, the returned information includes the following:</p> <ul style="list-style-type: none"> • Card Number, Card Serial Number, and Card ID (type). • Offsets, Negative Gains and Positive Gains for PGA values 0 through 7. • Offsets for Cold-Junction Temperature Sensors 1 through 4. • Time/Date of the last calibration. <p>For the Card ID, the types are as follows:</p> <table border="1" style="width: 100%; border-collapse: collapse; margin: 10px 0;"> <thead> <tr> <th style="width: 25%;">Card ID Types</th> <th style="width: 50%;">TempScan/1100 Scanning Card</th> <th style="width: 25%;">MultiScan/1200 Scanning Cards</th> </tr> </thead> <tbody> <tr> <td style="text-align: center;">-1</td> <td style="text-align: center;">No scanning card is installed</td> <td style="text-align: center;">No scanning card is installed</td> </tr> <tr> <td style="text-align: center;">0</td> <td style="text-align: center;">TempTC/32B thermocouple card</td> <td style="text-align: center;">(N/A)</td> </tr> <tr> <td style="text-align: center;">1</td> <td style="text-align: center;">TempV/32B volts card</td> <td style="text-align: center;">(N/A)</td> </tr> <tr> <td style="text-align: center;">2</td> <td style="text-align: center;">TempRTD/16B RTD card</td> <td style="text-align: center;">(N/A)</td> </tr> <tr> <td style="text-align: center;">16</td> <td style="text-align: center;">(N/A)</td> <td style="text-align: center;">MTC/24 thermocouple/volts card</td> </tr> <tr> <td style="text-align: center;">17</td> <td style="text-align: center;">(N/A)</td> <td style="text-align: center;">MHV/24 high-voltage card</td> </tr> </tbody> </table> <p>For information on selecting chassis, card only, or card/chassis information, see command <i>Select Card (C#)</i>.</p>			Card ID Types	TempScan/1100 Scanning Card	MultiScan/1200 Scanning Cards	-1	No scanning card is installed	No scanning card is installed	0	TempTC/32B thermocouple card	(N/A)	1	TempV/32B volts card	(N/A)	2	TempRTD/16B RTD card	(N/A)	16	(N/A)	MTC/24 thermocouple/volts card	17	(N/A)	MHV/24 high-voltage card
Card ID Types	TempScan/1100 Scanning Card	MultiScan/1200 Scanning Cards																					
-1	No scanning card is installed	No scanning card is installed																					
0	TempTC/32B thermocouple card	(N/A)																					
1	TempV/32B volts card	(N/A)																					
2	TempRTD/16B RTD card	(N/A)																					
16	(N/A)	MTC/24 thermocouple/volts card																					
17	(N/A)	MHV/24 high-voltage card																					
EXAMPLE																							
<pre> PRINT#1, "OUTPUT07; C#5X" PRINT#1, "OUTPUT07; QC?X" PRINT#1, "ENTER07" INPUT A\$ C#:005 SN:000000 ID:016 O:+00000 G:1.00000,1.00000 O:+00000 G:1.00000,1.00000 O:+00000 G:1.00000,1.00000 O:+00000 G:1.00000,1.00000 O:+00000 G:1.00000,1.00000 O:+00000 G:1.00000,1.00000 O:+00000 G:1.00000,1.00000 O:+00000 G:1.00000,1.00000 CJ:+00000,+00000,+00000,+00000# 01:34:23.6,08/23/97 </pre>																							
<p>' Select the fourth slave card - 5</p> <p>' Read back the fourth slave card information</p> <p>' Get response</p> <p>' Screen shows the following card information: On line 1, the Card Number, Card Serial Number, and Card ID (type); on lines 2 through 9, the Offsets, Negative Gains, and Positive Gains for PGA values 0 through 7; on line 10, the Offsets for Cold-Junction Temperature Sensors 1 through 4; and on the last line, the Time/Date of last calibration.</p>																							

R - Read Buffered Data

TYPE	Buffer	
EXECUTION	Immediate	
SYNTAX	Rtype	Read scan data from the Acquisition Buffer where type is the type of data request being made. Valid options for type are: 1 - Read the oldest scan currently residing in the Acquisition Buffer, 2 - Read the oldest complete <i>Trigger Block</i> currently residing in the Acquisition Buffer, and 3 - Read all the scan data that currently resides in the Acquisition Buffer.
	R?	Query the contents of the Acquisition Buffer.
DESCRIPTION		
<p>The TempScan/1100 or MultiScan/1200 Acquisition Buffer is a FIFO (First-In First-Out) buffer. In other words, the oldest scan data to be written into the buffer is the first scan data to be read from the buffer when a read operation is performed. Then once the scan data is read from the buffer by the controller, that data is erased from the buffer.</p> <p>To retrieve the scan data after a <i>Trigger</i> has occurred, the unit provides multiple query functions. The <i>Read Buffered Data (R)</i> command is used to retrieve data specifically from the Acquisition Buffer. You can use this command to read anywhere from one scan to all the scan data currently residing in the buffer. This command has the following valid options:</p> <ul style="list-style-type: none"> • Read the oldest scan currently residing in the Acquisition Buffer (R1). • Read the oldest complete <i>Trigger Block</i> currently residing in the Acquisition Buffer (R2). • Read all the scan data currently residing in the Acquisition Buffer (R3). <p>The <i>Read Buffer Data (R)</i> command operates as follows: When a command is interpreted, the requested scan data, if it exists, is moved one scan at a time from the Acquisition Buffer to the output queue where it will wait in state until you remove it. Once the data is removed from the output queue, the next <i>Read Buffered Data (R)</i> command may be issued.</p> <p>For more information on the Acquisition Buffer, see section <i>Acquisition Buffer</i> in the chapter <i>System Operation</i>. For information on formatting the query terminators for buffer data, see command <i>Set Query Terminators (Q)</i>.</p> <p>Note: If the appropriate amount of scan data is not in the Acquisition Buffer at the time these commands are issued, a Command Conflict Error will result.</p> <p>Note: For the MultiScan/1200 only, if the unit is in single-channel high-speed burst mode, then "scan" means one block of 256 samples.</p>		
EXAMPLE		
<pre> S% = 0 ' Wait for a scan While (S% and 8) = 0 PRINT#1 "SPOLL07" INPUT#2, S% WEND PRINT#1, "OUTPUT07;R1X" ' Get the scan PRINT#1, "ENTER07" LINE INPUT#2, A\$ </pre>		

R# - Read Last Readings

TYPE	System	
EXECUTION	Immediate	
SYNTAX	R#chans	Queries the last readings from the HLL Registers for specified channels. chans may be in two forms: chan (for a single channel where $1 \leq \text{chan} \leq \text{max}$) or first-last (for a range of channels where $1 \leq \text{first} < \text{last} \leq \text{max}$), where max = 992 for the TempScan/1100 and max = 744 for the MultiScan/1200.
DESCRIPTION		
<p>The <i>Read Last Readings (R#)</i> command will return the last readings for specific channels from the High/Low/Last (HLL) Registers, as a subset of the following <i>User Status (U)</i> command query - Query last scan read (U13) – which returns the last readings for all the configured channels in the scan. This command is useful for querying specific channels within the current channel configuration without having unwanted channels returned. The response to this command takes the same form as the U13 command query, whereby each reading conforms to the data output format specified via the <i>Set Data Format (F)</i> command. In addition, each channel is terminated by the query terminator h11, as specified via the <i>Set Query Terminator (Q)</i> command.</p> <p>For more information on the HLL Registers or data output formats, see section <i>High/Low/Last (HLL) Registers</i> in the chapter <i>System Operation</i>, or see section <i>Data Format Configuration</i> in the chapter <i>System Configuration</i>.</p>		
EXAMPLE		
<pre> PRINT#1, "OUTPUT07;C1-32,1X" ' Configure Channels 1 - 32 for Type J thermocouples PRINT#1, "OUTPUT07;F1,0X" ' Set format for engineering units degrees C PRINT#1, "OUTPUT07;R#32X" ' Get the last reading for Channel 32 PRINT#1, "ENTER07" LINE INPUT #2, R\$ PRINT R\$ ' Screen shows the last reading +0103.20 (Channel 32 is 103.2 °C) PRINT#1, "OUTPUT07;R#1-4X" ' Get the last readings for Channels 1 - 4 PRINT#1, "ENTER07" LINE INPUT #2, S\$ PRINT S\$ ' Screen shows the last readings -0003.70 (Channel 1 is -3.7 °C) +0005.60 (Channel 2 is 5.6 °C) +0010.20 (Channel 3 is 10.2 °C) +0024.40 (Channel 4 is 24.4 °C) </pre>		

S - Set Real-Time Clock

TYPE	System	
EXECUTION	Immediate	
SYNTAX	s time	Set the internal real-time clock where time is in the standard Time/Date input format: hh:mm:ss:t,MM/DD/YY where hh is in hours, mm is in minutes, ss is in seconds, t is in tenths of a second, MM is the month, DD is the day, and YY is the year.
	s?	Query the internal real-time clock.
DESCRIPTION		
<p>The <i>Set Real-Time Clock (s)</i> command is used to set the battery-backed-up internal real-time clock of the unit. The time argument follows the same format as the standard Time/Date input format. In order for the Time/Date stamping of output data to be accurate, the real-time clock must be set to an accurate Time/Date. Once set, the real-time clock will remember the current time, even when powered off.</p> <p>For more information on the real-time clock, Time/Date stamping and data formats, see section <i>Additional Configuration</i>, section <i>Stamping Configuration</i> and section <i>Data Format Configuration</i>, respectively, in the chapter <i>System Configuration</i>.</p>		
EXAMPLE		
<pre>PRINT#1, "OUTPUT07; S14:00:00.0,4/30/97X" ' Current date and time</pre>		

T - Set Trigger Configuration

TYPE	Acquisition	
EXECUTION	Deferred	
SYNTAX	Tstart, stop, re-arm, sync	Configure an acquisition of scan data with the following parameters: start is the start event and stop is the stop event re-arm determines if the unit should continue acquiring after the first acquisition completes, where 1 is on and 0 is off. sync determines if acquisition events should be synchronized with the internal timebases, where 1 is on and 0 is off.
	T?	Query the present trigger configuration

DESCRIPTION

The *Set Trigger Configuration (T)* command is used as the central command to assign the following events to the TempScan/1100 or MultiScan/1200 unit: The *Trigger* (trigger start event) and the *Stop* (trigger stop event). The *Trigger* and *Stop* may also be assigned different trigger sources. In addition, the *Set Trigger Configuration (T)* command also determines whether or not, after the initial acquisition, the acquisition will be re-enabled automatically, and whether or not the *Trigger* (trigger start event) should be synchronized with the *Pre-Trigger* scan interval.

Since the *Set Trigger Configuration (T)* command governs the configuration of an acquisition, all other acquisition-dependent commands should be sent before the trigger sources are assigned via the *Set Trigger Configuration (T)* command. The required acquisition-dependent commands will depend on the selected trigger sources. For instance, if the unit is configured for *Trigger On (@)* command, it will not be necessary to send the unrelated *Set Trigger Level (L)* command.

The following table lists the valid trigger types and their associated commands prior to trigger configuration:

Trigger Type	Trigger Source Description	Required Commands Prior To Trigger Configuration		Optional Commands Prior To Trigger Configuration
		With Pre-Trigger/ Post-Stop Scans	Without Pre-Trigger/ Post-Stop Scans	
0	None - Event Not Defined	(N/A)	(N/A)	(N/A)
1	Trigger on (@) Command	I, Y	I	(N/A)
2	Trigger on GET (IEEE 488 only)	I, Y	I	(N/A)
3	Trigger on TALK (IEEE 488 only)	I, Y	I	(N/A)
4	Trigger on Channel Above Level	I, Y, L	I, L	(N/A)
5	Trigger on Channel Below Level	I, Y, L	I, L	(N/A)
6	Trigger on TTL Signal Rising	I, Y	I	(N/A)
7	Trigger on TTL Signal Falling	I, Y	I	(N/A)
8	Trigger on Count	I, Y	I, Y	(N/A)
9	Trigger on Alarm Turning On	I, Y, C	I, C	A
10	Trigger on Alarm Turning Off	I, Y, C	I, C	A
11	Trigger on Absolute Time	I, Y, P	I, P	(N/A)

The first parameter **start** defines the *Trigger* (trigger start event) that is to take place in order for the unit to begin acquiring *Post-Trigger* scans. Setting the **start** parameter to 0 will disable the acquiring of *Post-Trigger* scans; this may be performed at any time during or after an acquisition. The **start** parameter will automatically be set to 0 upon the termination of an acquisition unless the **re-arm** flag is set to 1.

The second parameter **stop** defines the *Stop* (trigger stop event) that is to take place in order for the unit to stop acquiring *Post-Trigger* scans. Setting the **stop** parameter to 0 will have the same effect as setting the **stop** parameter to type 8 (Trigger on Count) with the *Post-Stop* count (Y command) set to 0. In both cases, the *Post-Trigger* scans will be collected and the acquisition immediately terminated.

The third parameter **re-arm** defines the *Auto Re-arm* feature which determines whether successive acquisitions will be re-enabled automatically, or remain disabled after the initial acquisition has terminated.

The fourth parameter **sync** defines the trigger synchronization flag which determines whether the *Trigger* will be synchronized with the *Pre-Trigger* scan interval (I command), or begin as soon as the *Trigger* is detected, regardless of the exact time it occurred.

For more information on *Trigger* and *Stop* configuration, see section *Trigger Configuration* in the chapter *System Configuration*.

Note: If the *Trigger* and *Stop* are assigned different trigger types (sources), a combination of the acquisition-dependent commands prior to trigger configuration is required.

Note: For the MultiScan/1200 unit to recognize a *Trigger* (trigger start event) source which is set to TTL Level or Alarm, at least one *Pre-Trigger* scan must be programmed via the *pre* parameter of the *Set Counts (Y)* command, to initiate scanning.

EXAMPLE

<code>PRINT#1, "OUTPUT07;Y100,10000,0X"</code>	' Set <i>Pre-Trigger</i> count to 100, <i>Post-Trigger</i> count to 10000 and define no <i>Post-Stop</i> count
<code>PRINT#1, "OUTPUT07;T1,8,0,1X"</code>	' Set <i>Trigger</i> as <i>Trigger On (@)</i> command, set <i>Stop</i> as <i>Post-Trigger</i> Count (10000) and synchronize the <i>Trigger</i> to the <i>Pre-Trigger</i> timebase interval
<code>PRINT#1, "OUTPUT07;@X"</code>	' Issue <i>Trigger</i>

U - User Status

TYPE	System																																			
EXECUTION	Immediate																																			
SYNTAX	Ureq	Request information about various internal conditions of the unit where req refers to one of the following request types: 0 - Query and clear the Event Status Register (ESR) 1 - Query the Status Byte Register (STB) 2 - Query and clear the Calibration Status Register (CSR) 3 - Query the current system settings 4 - Query the current High/Low/Last (HLL) Registers 5 - Query and clear the current High/Low/Last (HLL) Registers 6 - Query the Buffer Status String 7 - Query the assigned alarm outputs 8 - Query the configured channels 9 - Query the digital inputs 10 - Query the installed memory option 11 - Query the current alarm channels 12 - Query the Time/Date stamping of the last calibration 13 - Query the last scan read 14 - Query the card ID types 15 - Query the product information 16 - Query the measuring mode parameters (MultiScan/1200 only) 17 - Query the Root Mean Square (RMS) value (MultiScan/1200 only) 18 - Query the acquisition states and various system flags																																		
DESCRIPTION																																				
<p>The <i>User Status</i> (U) command is used to return information about various conditions of the unit, and may be sent at any time without interfering with normal operation. The following text provides more detailed information about the <i>User Status</i> (U) command responses.</p> <ul style="list-style-type: none"> • U0: Query and clear the Event Status Register (ESR). This request responds with an integer nnn of the form $000 \leq nnn \leq 255$, where the individual values are as follows, and multiple values are summed: <table style="width: 100%; border: none;"> <tr> <td style="width: 50%;">128 - Power On (Bit 7)</td> <td style="width: 50%;">008 - Device Dependent Error (Bit 3)</td> </tr> <tr> <td>064 - Buffer 75% Full (Bit 6)</td> <td>004 - Query Error (Bit 2)</td> </tr> <tr> <td>032 - Command Error (Bit 5)</td> <td>002 - Stop Event (Bit 1)</td> </tr> <tr> <td>016 - Execution Error (Bit 4)</td> <td>001 - Acquisition Complete (Bit 0)</td> </tr> </table> • U1: Query the Status Byte Register (STB). This request responds with an integer nnn of the form $000 \leq nnn \leq 255$, where the individual values are as follows, and multiple values are summed: <table style="width: 100%; border: none;"> <tr> <td style="width: 50%;">128 - Buffer Overrun (Bit 7)</td> <td style="width: 50%;">008 - Scan Available (Bit 3)</td> </tr> <tr> <td>064 - RQS or MSS (Bit 6)</td> <td>004 - Ready (Bit 2)</td> </tr> <tr> <td>032 - Event Detected (Bit 5)</td> <td>002 - Triggered (Bit 1)</td> </tr> <tr> <td>016 - Message Available (Bit 4)</td> <td>001 - Alarm (Bit 0)</td> </tr> </table> • U2: Query and clear the Calibration Status Register (CSR). This request responds with an integer nnn of the form $000 \leq nnn \leq 255$, where the separate values are as follows, and multiple values are summed. The CSR Bits 7 and 6 respond with the following combined values: <table style="width: 100%; border: none;"> <tr> <td style="width: 50%;">192 - Calibration Mode, Command Active (Both Bits 7 and 6)</td> <td style="width: 50%;">064 - EEPROM Test Mode (Bit 6 only) (Not discussed in this manual.)</td> </tr> <tr> <td>128 - Calibration Mode, Idle (Bit 7 only)</td> <td>000 - Normal Run Mode (Neither Bit 7 nor 6)</td> </tr> </table> <p>Meanwhile, the CSR Bits 5 through 0 respond with the following individual values:</p> <table style="width: 100%; border: none;"> <tr> <td style="width: 50%;">If in Normal Run Mode (000), then:</td> <td style="width: 50%;">If in either Calibration Modes (192 or 128), then:</td> </tr> <tr> <td>032 - Read Failure (Bit 5)</td> <td>032 - Read Failure – EEPROM Error (Bit 5)</td> </tr> <tr> <td>016 - Write Failure (Bit 4)</td> <td>016 - Write Failure – EEPROM Error (Bit 4)</td> </tr> <tr> <td>008 - Checksum Error (Bit 3)</td> <td>008 - Checksum Error – EEPROM Error (Bit 3)</td> </tr> <tr> <td>004 - NV-RAM Error (Bit 2)</td> <td>004 - Calibration Error (Bit 2)</td> </tr> <tr> <td>002 - Invalid Password (Bit 1)</td> <td>002 - Invalid Password (Bit 1)</td> </tr> <tr> <td>001 - Invalid Command (Bit 0)</td> <td>001 - Invalid Command (Bit 0)</td> </tr> </table> 			128 - Power On (Bit 7)	008 - Device Dependent Error (Bit 3)	064 - Buffer 75% Full (Bit 6)	004 - Query Error (Bit 2)	032 - Command Error (Bit 5)	002 - Stop Event (Bit 1)	016 - Execution Error (Bit 4)	001 - Acquisition Complete (Bit 0)	128 - Buffer Overrun (Bit 7)	008 - Scan Available (Bit 3)	064 - RQS or MSS (Bit 6)	004 - Ready (Bit 2)	032 - Event Detected (Bit 5)	002 - Triggered (Bit 1)	016 - Message Available (Bit 4)	001 - Alarm (Bit 0)	192 - Calibration Mode, Command Active (Both Bits 7 and 6)	064 - EEPROM Test Mode (Bit 6 only) (Not discussed in this manual.)	128 - Calibration Mode, Idle (Bit 7 only)	000 - Normal Run Mode (Neither Bit 7 nor 6)	If in Normal Run Mode (000), then:	If in either Calibration Modes (192 or 128), then:	032 - Read Failure (Bit 5)	032 - Read Failure – EEPROM Error (Bit 5)	016 - Write Failure (Bit 4)	016 - Write Failure – EEPROM Error (Bit 4)	008 - Checksum Error (Bit 3)	008 - Checksum Error – EEPROM Error (Bit 3)	004 - NV-RAM Error (Bit 2)	004 - Calibration Error (Bit 2)	002 - Invalid Password (Bit 1)	002 - Invalid Password (Bit 1)	001 - Invalid Command (Bit 0)	001 - Invalid Command (Bit 0)
128 - Power On (Bit 7)	008 - Device Dependent Error (Bit 3)																																			
064 - Buffer 75% Full (Bit 6)	004 - Query Error (Bit 2)																																			
032 - Command Error (Bit 5)	002 - Stop Event (Bit 1)																																			
016 - Execution Error (Bit 4)	001 - Acquisition Complete (Bit 0)																																			
128 - Buffer Overrun (Bit 7)	008 - Scan Available (Bit 3)																																			
064 - RQS or MSS (Bit 6)	004 - Ready (Bit 2)																																			
032 - Event Detected (Bit 5)	002 - Triggered (Bit 1)																																			
016 - Message Available (Bit 4)	001 - Alarm (Bit 0)																																			
192 - Calibration Mode, Command Active (Both Bits 7 and 6)	064 - EEPROM Test Mode (Bit 6 only) (Not discussed in this manual.)																																			
128 - Calibration Mode, Idle (Bit 7 only)	000 - Normal Run Mode (Neither Bit 7 nor 6)																																			
If in Normal Run Mode (000), then:	If in either Calibration Modes (192 or 128), then:																																			
032 - Read Failure (Bit 5)	032 - Read Failure – EEPROM Error (Bit 5)																																			
016 - Write Failure (Bit 4)	016 - Write Failure – EEPROM Error (Bit 4)																																			
008 - Checksum Error (Bit 3)	008 - Checksum Error – EEPROM Error (Bit 3)																																			
004 - NV-RAM Error (Bit 2)	004 - Calibration Error (Bit 2)																																			
002 - Invalid Password (Bit 1)	002 - Invalid Password (Bit 1)																																			
001 - Invalid Command (Bit 0)	001 - Invalid Command (Bit 0)																																			

- U3:** Query the current system settings. This request is equivalent to the following string of queries: **F?I?L?P?Q?S?T?Y?** Consequently, this request responds with the following data in their respective forms for all of the configured channels, according to the user-defined data and terminator formats:

Fengr,format	Qresp,hll,scan,block,sep
Inorm,acq	Stime
Lchan,level,hyst	Tstart,stop,re-arm,sync
Pstart,stop	Ypre,post,stop
- U4:** Query the current High/Low/Last (HLL) Registers. This request responds with the HLL Registers data for all of the configured channels, according to the user-defined data and terminator formats. For more information, see section *High/Low/Last (HLL) Registers* in the chapter *System Operation*.
- U5:** Query and clear the current High/Low/Last (HLL) Registers. This request responds with the HLL Registers data for all of the configured channels, according to the user-defined data and terminator formats, and clears out the current High and Low readings for all of the configured channels. For more information, see section *High/Low/Last (HLL) Registers* in the chapter *System Operation*.
- U6:** Query the Buffer Status String. This request responds with the following Buffer Status String data fields. For more information, see section *Acquisition Buffer* in the chapter *System Operation*.

Number of Trigger Blocks Available (Field 1)	Position of Stop Event Pointer (Field 5)
Number of Scans Available (Field 2)	Time/Date Stamping of Stop Event (Field 6)
Current Position of Read Pointer (Field 3)	Position of End Scan Pointer (Field 7)
Time/Date Stamping of Trigger Event (Field 4)	Status of Current Trigger Block (Field 8)
- U7:** Query the assigned alarm outputs. This request responds with the current digital alarm output configuration in the form **Achan,output** for all channels that are currently assigned to digital outputs, according to the user-defined data and terminator formats. (The **A?** command query only responds with the current configuration or mode of the previously executed **A** command.)
- U8:** Query the configured channels. This request responds with the current channel configuration in the form **Cchans,type[,lowsp,highsp,hyst]** for all of the configured channels, according to the user-defined data and terminator formats. (The **C?** command query only responds with the current configuration or mode of the previously executed **C** command.)
- U9:** Query the digital inputs. This request responds with the current state of the eight digital inputs (provided via the rear panel DB50 digital I/O connector), as reflected in the active digital input lines of the connected instrument. For more information, see command *Set Digital Input Stamping (I#)*.
- U10:** Query the installed memory option. This request responds with the current amount of memory installed (in kilobytes), as follows:

00256 - 256 KB option	04096 - 4 MB option
01024 - 1 MB option	08192 - 8 MB option
- U11:** Query the current alarm channels. This request responds with all of the channels which have been programmed with valid alarm setpoints, in the form **ccc,a,ccc,a,ccc,a,...** etc., where **ccc** is a 3-digit channel number and **a** is the current alarm state of that channel number. For example, a response may be: **001,0,008,1,013,1,512,1,690,0** which indicates that at the time of the query, Channels 1 and 690 were not in an alarm state, whereas Channels 8, 13, and 512 were in an alarm state.
- U12:** Query the Time/Date stamping of the last calibration. This request responds with a number sign (#) to distinguish this Time/Date stamping from other Time/Date stampings, followed by the Time/Date of the last calibration, according to the user-defined data formats. For example, a response in absolute Engineering Units may be: **#12:31:01.237,04/24/97**
- U13:** Query the last scan read. This request responds with the HLL Registers data for all of the configured channels of the last scan only, according to the user-defined data and terminator formats. For more information, see section *High/Low/Last (HLL) Registers* in the chapter *System Operation*.
- U14:** Query the card ID types. This request responds with the card ID types for all of the maximum 31 scanning card slots in the system, whether or not the system is expanded, as follows:

For the TempScan/1100 system:	For the MultiScan/1200 system:
-1 - No scanning card is installed.	-1 - No scanning card is installed.
0 - TempTC/32B thermocouple card.	16 - MTC/24 thermocouple/volts card.
1 - TempV/32B volts card.	17 - MHV/24 high-voltage card
2 - TempRTD/16B RTD card	

Note that the **U14** command can only be issued when all of the channels are in an unconfigured state. Otherwise, if any channels are configured, the system will issue a Command Conflict Error. To clear any configured channels, issue the *Clear Channel Configuration (*C)* command.

- **U15:** Query the product information. This request responds with the current TempScan/1100 or MultiScan/1200 product information including version levels.
 - **U16:** Query the measuring mode parameters (MultiScan/1200 only). For the MultiScan/1200 only, this request is equivalent to the following string of measuring mode queries: **M#?F#?W#?** Consequently, this request responds with the following measuring mode data in their respective forms:
M#mode F#freq W#wt
 - **U17:** Query the Root Mean Square (RMS) value (MultiScan/1200 only). For the MultiScan/1200 only, this request responds with the Root Mean Square (RMS) value computed from the last-completed acquisition in single-channel high-speed burst mode. For more information, see section *Measuring Modes (MultiScan/1200 Only)* in the chapter *System Configuration*.
 - **U18:** Query the acquisition states and various system flags. This request responds with an integer **nnn** of the form $000 \leq nnn \leq 255$, where the separate values are as follows, and multiple values are summed. The **U18** Bits 7 through 4 respond with the following individual values:

128 - Acquisition Block Available (Bit 7)	032 - Not used.
064 - Power up under default configuration (Bit 6). Otherwise, power up under the last configuration.	016 - Scan Alarm Stamping Enabled (Bit 4)

Meanwhile, the **U18** Bits 3 and 2 respond with the following combined values:

012 - Not used.	004 - Absolute Scan Time Stamping Enabled (Bit 2 only)
008 - Relative Scan Time Stamping Enabled (Bit 3 only)	000 - Scan Time Stamping Not Enabled (Neither Bits 3 nor 2)

Lastly, the **U18** Bits 1 and 0 respond with the following combined values:

003 - Acquiring Post-Stop Scan Data (Both Bits 1 and 0)	001 - Armed – Acquisition is armed and may be acquiring Pre-Trigger Scan Data (Bit 0 only)
002 - Acquiring Post-Trigger Scan Data (Bit 1 only)	000 - Idle – No acquisition is armed or acquiring any scan data (Neither Bit 1 nor Bit 0)
- Note:** Except for calibration errors, any other error conditions are cleared after the status string is read by the controller. Meanwhile, calibration errors are cleared when the unit is calibrated.
- Note:** Status strings are returned when the unit is next addressed to TALK. If the unit is configured to Trigger on TALK, requesting a status report will not cause the unit to trigger.

EXAMPLES

Refer to the **EXAMPLES** section for each of the following commands:

- ***K** - Change Calibration Keyword
- C** - Configure Channels
- C#** - Select Card
- F** - Set Data Format
- K** - Enter Calibration Mode
- Q** - Set Query Terminator
- X** - Execute
- Y** - Set Counts

V - Set User Terminator

TYPE	System	
EXECUTION	Deferred	
SYNTAX	Vval	Set the User Terminator value to any character whose numeric value (ASCII value) val is in the range 0 to 255.
	V?	Query the present User Terminator value.
DESCRIPTION		
<p>The <i>Set User Terminator (V)</i> command is used to set the user-defined User Terminator value to any character whose numeric value (ASCII value) is in the range 0 to 255. The User Terminator may be used by the <i>Set Query Terminator (Q)</i> command to specify a user-defined terminator for any of the defined terminator types or as a reading separator for the <i>Read Buffered Data (R)</i> command.</p> <p>For more information on data output (or query) terminators, see command <i>Set Query Terminator (Q)</i>, or see section <i>Data Format Configuration</i> in the chapter <i>System Configuration</i>. For more information on ASCII characters, see section <i>Appendix B</i>.</p>		
EXAMPLE		
<pre> PRINT#1, "OUTPUT07;Q1,0,1,1,1X" ' Set the reading separator (fifth parameter) flag on PRINT#1, "OUTPUT07;F0,0X" ' Data format is Engineering Units, degrees Celsius PRINT#1, "OUTPUT07;V44X" ' Set the User Terminator to be a comma (,) PRINT#1, "OUTPUT07;C1-4,1X" ' Configure Channels 1 - 4 as Type J thermocouples PRINT#1, "OUTPUT07;I00:00:01.0, ' Configure scan interval 00:00:00.1" PRINT#1, "OUTPUT07;Y0,1000,0X" ' Configure Post-Trigger Counts PRINT#1, "OUTPUT07;T1,8,0,0X" ' Set Trigger as Trigger On (@) command, and set Stop as Counts PRINT#1, "OUTPUT07;@X" ' Trigger the acquisition PRINT#1, "OUTPUT07;R1X" ' Read oldest scan PRINT#1, "ENTER07" ' Retrieve the oldest scan INPUT A\$ ' Screen shows the scan data readings separated by 0020.30,0023.80,0034.90,0013.50 commas PRINT#1, "OUTPUT07;V58X" ' Set the User Terminator to be a colon (:) PRINT#1, "OUTPUT07;R1X" ' Read the next scan PRINT#1, "ENTER07" ' Retrieve the next scan INPUT A\$ ' Screen shows scan data readings separated by colons 0020.30:0023.80:0034.90:0013.50 </pre>		

W# - Set Averaging Weight

MultiScan/1200 only																	
TYPE	System																
EXECUTION	Deferred																
SYNTAX	W#wt	Specify the number of samples to average in line cycle integration / high-speed multi-channel mode where wt is the averaging weight. Valid options for wt are: 1, 2, 4, 8, 16, 32 (default), 64, 128, and 256 .															
DESCRIPTION																	
<p>The <i>Set Averaging Weight (W#)</i> command selects how many samples to average for each thermocouple or DC volts channel, or how many samples over which the Root Mean Square (RMS) is calculated for AC volts. When the MultiScan/1200 unit is in line cycle integration/high-speed multi-channel mode with the default weight of 32 samples per channel, the unit can provide AC voltage, DC voltage, and thermocouple readings at a rate of up to 44 channels per second.</p> <p>Further noise filtering is available with averaging over 2, 4, or 8 line cycles (at 32 samples per line cycle) by selecting a weight of 64, 128, or 256 samples, respectively. If noise resulting from AC line pickup is not a concern, you can program the MultiScan/1200 unit to average 1, 2, 4, 8, or 16 samples per channel for faster scanning throughput.</p>																	
<table border="1" style="width: 100%; border-collapse: collapse;"> <thead> <tr style="background-color: #f2f2f2;"> <th style="width: 33%;">Weight (wt)</th> <th style="width: 33%;">Line Cycles (32 Measurements Each)</th> <th style="width: 33%;">Maximum Number of Channels</th> </tr> </thead> <tbody> <tr> <td style="text-align: center;">1, 2, 4, 8, 16, 32</td> <td style="text-align: center;">1</td> <td style="text-align: center;">744</td> </tr> <tr> <td style="text-align: center;">64</td> <td style="text-align: center;">2</td> <td style="text-align: center;">431</td> </tr> <tr> <td style="text-align: center;">128</td> <td style="text-align: center;">4</td> <td style="text-align: center;">234</td> </tr> <tr> <td style="text-align: center;">256</td> <td style="text-align: center;">8</td> <td style="text-align: center;">122</td> </tr> </tbody> </table>			Weight (wt)	Line Cycles (32 Measurements Each)	Maximum Number of Channels	1, 2, 4, 8, 16, 32	1	744	64	2	431	128	4	234	256	8	122
Weight (wt)	Line Cycles (32 Measurements Each)	Maximum Number of Channels															
1, 2, 4, 8, 16, 32	1	744															
64	2	431															
128	4	234															
256	8	122															
<p>For more information on MultiScan/1200 measuring mode parameters, see section <i>Measuring Modes (MultiScan/1200 Only)</i> in the chapter <i>System Configuration</i>, and see commands <i>Set Burst Mode Frequency (F#)</i> and <i>Set Measuring Mode (M#)</i>.</p> <p>Note: Due to hardware constraints, weights greater than 32 (default) limit the number of channels which can be active in an acquisition.</p> <p>Note: The MultiScan/1200 unit only supports the measurement of AC voltages where the frequency of the input signal is an integer multiple of the AC line cycle. Consequently, sampling weights less than 32 can yield incorrect results. In order to compute an accurate V_{rms} value, you must program a frequency which will yield a sufficient even integer number of samples per line cycle.</p>																	
EXAMPLE																	
<pre>PRINT#1, "OUTPUT07;M#0X" ' Select line cycle integration/high-speed multi-channel mode PRINT#1, "OUTPUT07;W#64X" ' Select number of samples = 64 PRINT#1, "OUTPUT07;Y0,10,0X" ' Setup to read 10 Post-Trigger scans PRINT#1, "OUTPUT07;C1-3,1X" ' Enable Channels 1 - 3 for Type J thermocouples PRINT#1, "OUTPUT07;T1,8,0,0X" ' Arm the unit PRINT#1, "OUTPUT07;@X" ' Trigger unit and collect scans</pre>																	

X - Execute

TYPE	System	
EXECUTION	Immediate	
SYNTAX	X	Execute preceding command string.
DESCRIPTION		
<p>Deferred commands are interpreted and processed in the Acquisition Buffer as they are received, but they require the <i>Execute (X)</i> command to be issued in order to be executed. If multiple system commands are used in the same string, each use of the command must be followed by the <i>Execute (X)</i> command. Any number of <i>Execute (X)</i> commands may be inserted into the same command string. However, immediate commands do not require an <i>Execute (X)</i> command to be processed.</p> <p>While a command line is being interpreted, the front panel LED indicators will not be updated. These LED indicators will only be updated when the unit is in a ready state. In order to determine if the unit is in a ready state, perform a Serial Poll on the Status Byte Register (STB) for the Ready Bit (Bit 3).</p> <p>For more detail on deferred and immediate command types, see section <i>Command Interpretation</i> at the beginning of this chapter.</p>		
EXAMPLE		
<pre> PRINT#1, "CLEAR07" ' Clear the unit PRINT#1, "OUTPUT07;*C" ' Clear the current channel configuration PRINT#1, "OUTPUT07;C1-16,1 C17,2 C18-32,3" ' Send channel configuration PRINT#1, "OUTPUT07;U4" ' Get HLL data for the new channel configuration. (Note: ERROR LED indicator turns on) PRINT#1, "OUTPUT07;X" ' Instruct the unit to execute the U4 command. Now the unit has its new channel configuration PRINT#1, "OUTPUT07;E?X" ' Find out what caused the error PRINT#1, "ENTER07" ' Retrieve error response INPUT A\$ E128 ' Screen shows E128 - Command Conflict Error, due to fact that no channels were configured (C is a deferred command) when the U4 was executed (U4 is an immediate command) </pre>		

Y - Set Counts

TYPE	Acquisition													
EXECUTION	Deferred													
SYNTAX	Ypre, post, stop	Set acquisition counts where pre is the <i>Pre-Trigger</i> count, post is the <i>Post-Trigger</i> count and stop is the <i>Post-Stop</i> count.												
	Y?	Query current acquisition count selections.												
DESCRIPTION														
<p>For either the TempScan/1100 or MultiScan/1200 unit, the <i>Set Counts</i> (Y) command is used to set a <i>Pre-Trigger</i>, <i>Post-Trigger</i>, and <i>Post-Stop</i> scan count to define the size of the acquisition. The optional <i>Pre-Trigger</i> count cannot exceed the memory size, but the required <i>Post-Trigger</i> count can. If the <i>Post-Trigger</i> count exceeds the memory size, it is the responsibility of the PC/IEEE 488 controller to deplete the FIFO Acquisition Buffer as the data is being collected, or else a buffer overrun error will occur. The optional <i>Post-Stop</i> count can also be associated with an acquisition to collect samples after the <i>Stop</i> (trigger stop event) occurs.</p> <p>If a <i>Trigger</i> (trigger start event) is encountered before the <i>Pre-Trigger</i> count is satisfied, the unit will trigger but have fewer than the specified <i>Pre-Trigger</i> count in its buffer. The following <i>User Status</i> (U) command query – Query the Buffer Status String (U6) – can be used to check the <i>Pre-Trigger</i> count. Although normal <i>Pre-Trigger</i> scans are acquired as soon as the acquisition is armed, they are not available or valid until the <i>Trigger</i> occurs.</p> <p>For the MultiScan/1200 only, in single-channel high-speed burst mode, samples are internally collected for the selected channel in 256-sample blocks. However, this externally appears the same as 256-channel scans in the line-cycle integration / high-speed multi-channel mode. That is, when you program the number of 256-sample blocks in the <i>Post-Trigger</i> count parameter post of the <i>Set Counts</i> (Y) command, you will retrieve the data from the MultiScan/1200 unit as "<i>Post-Trigger</i> count" scans of 256 samples.</p> <p>The single-channel high-speed burst mode is a one-shot operation, since it collects the specified number of samples and then stops. It is not continuous, and does not allow memory overflow and wrap-around. The maximum amount of samples which can be taken is dictated by the amount of memory available, as follows:</p> <table border="1" style="margin-left: auto; margin-right: auto; border-collapse: collapse;"> <thead> <tr> <th colspan="2" style="text-align: center;">Single-Channel High-Speed Burst Mode</th> </tr> <tr> <th style="text-align: center;">System Memory</th> <th style="text-align: center;">"Post-Trigger Count"</th> </tr> </thead> <tbody> <tr> <td style="text-align: center;">256 Kbytes</td> <td style="text-align: center;">2 to 512</td> </tr> <tr> <td style="text-align: center;">1 Megabytes</td> <td style="text-align: center;">2 to 2048</td> </tr> <tr> <td style="text-align: center;">4 Megabytes</td> <td style="text-align: center;">2 to 8192</td> </tr> <tr> <td style="text-align: center;">8 Megabytes</td> <td style="text-align: center;">2 to 16384</td> </tr> </tbody> </table> <p>Note: The TempScan/1100 or MultiScan/1200 unit can be configured to have different timebases for its <i>Pre-Trigger</i> and <i>Post-Trigger</i> states. When the <i>Trigger</i> condition is satisfied, the unit goes from the <i>Pre-Trigger</i> state to the <i>Post-Trigger</i> state, changing its timebase, if configured to do so. For more information, see section <i>Acquisition Configuration</i> in the chapter <i>System Configuration</i>.</p> <p>Note: For the MultiScan/1200 only, in single-channel high-speed burst mode, the <i>Post-Trigger</i> count parameter post is used to select the number of 256-sample blocks to collect.</p>			Single-Channel High-Speed Burst Mode		System Memory	"Post-Trigger Count"	256 Kbytes	2 to 512	1 Megabytes	2 to 2048	4 Megabytes	2 to 8192	8 Megabytes	2 to 16384
Single-Channel High-Speed Burst Mode														
System Memory	"Post-Trigger Count"													
256 Kbytes	2 to 512													
1 Megabytes	2 to 2048													
4 Megabytes	2 to 8192													
8 Megabytes	2 to 16384													
EXAMPLE														
<pre>PRINT#1, "OUTPUT07;Y100,1000,50X"</pre>	† Configure acquisition counts for 100 <i>Pre-Trigger</i> scans, 1000 <i>Post-Trigger</i> scans, and 50 <i>Post-Stop</i> scans													
<pre>PRINT#1, "OUTPUT07;N0 N2 X"</pre>	† Configure Event Status Register Bit (ESB) of the Status Byte Register (STB) to be set when the <i>Pre-Trigger</i> count is satisfied													
<pre>PRINT#1, "OUTPUT07;T1,8,0,0X"</pre>	† Set <i>Trigger</i> as <i>Trigger On</i> (@) command, and set <i>Stop</i> as Counts													

? - Query

TYPE	System	
EXECUTION	Immediate	
SYNTAX	?	Query the present configuration or mode of the command preceding the ?
DESCRIPTION		
<p>Most commands have a corresponding query command formed by appending the question mark (?) command extension. Stored in the output queue until the PC/IEEE 488 controller retrieves them, query command responses consist of the present configuration or mode of the previously-executed command. When appropriate, these query command responses take the form of a command string which, if it were executed, would put the unit into the configuration it was in when the query was executed.</p> <p>For example, the <i>Set User Terminator (V)</i> command query <i>V?</i> gives its response in the following form: Vva1 where $0 \leq va1 \leq 255$. This response is in the form of the previous <i>Set User Terminator (V)</i> command and, if it is sent to the unit, it would set the user-defined User Terminator to the same value that it had when the query was issued.</p> <p>Query commands are immediate. However, even though query commands generate their responses as soon as they are interpreted, before any other commands including the <i>Execute (X)</i> command, they must still be followed by this <i>Execute (X)</i> command for proper termination. Any number of query commands can be combined into one command string to create a specialized status command that responds with only the information of interest for a given application. Query command responses are always fixed-length strings in a pre-defined format.</p> <p>For more information on command execution, see section <i>Command Interpretation</i> at the beginning of this chapter, and see command <i>Execute (X)</i>.</p>		
EXAMPLE		
<pre> PRINT#1, "OUTPUT07; V1X V?X" ' Get the response of the current User Terminator PRINT#1, "ENTER07" ' Retrieve response INPUT A\$ PRINT A\$ ' Screen shows the current User Terminator V1 V1 PRINT#1, "OUTPUT07; V0X V?X" ' Change the User Terminator and get response PRINT#1, "ENTER07" ' Retrieve response INPUT A\$ PRINT A\$ ' Screen shows new User Terminator V0 V0 PRINT#1, "OUTPUT07; V4 V?X" ' Change User Terminator and get response, without using ' the intermediate Execute (X) command PRINT#1, "ENTER07" ' Retrieve response INPUT A\$ PRINT A\$ ' Screen still shows the V0 because the immediate ' command V? was executed before the deferred ' command V4 V0 PRINT#1, "OUTPUT07; V?X" ' Again get the response of the current User Terminator PRINT#1, "ENTER07" ' Retrieve response INPUT A\$ PRINT A\$ ' Screen shows new User Terminator V4 V4 </pre>		

IEEE 488 Bus & Serial Bus Lines	337
IEEE 488 Bus Commands	338
ASCII Codes	339
ASCII Code Summary.....	339
ASCII Code Details.....	341

IEEE 488 Bus & Serial Bus Lines

Bus State	Bus Line	Data Transfer (DIO) Lines							
		8	7	6	5	4	3	2	1
Bus Management Lines									
IFC	Interface Clear								
REN	Remote Enable								
IEEE 488 Interface: Bus Management Lines									
ATN	Attention (\$04)	0	0	0	0	0	1	0	0
EOI	End-Or-Identify (\$80)	1	0	0	0	0	0	0	0
SRQ	Service Request (\$40)	0	1	0	0	0	0	0	0
IEEE 488 Interface: Handshake Lines									
DAV	Data Valid (\$08)	0	0	0	0	1	0	0	0
NDAC	Not Data Accepted (\$10)	0	0	0	1	0	0	0	0
NRFD	Not Ready For Data (\$20)	0	0	1	0	0	0	0	0
Serial Interface: Bus Management Lines									
DTR	Data Terminal Ready (\$02)	0	0	0	0	0	0	1	0
RI	Ring Indicator (\$10)	0	0	0	1	0	0	0	0
RTS	Request To Send (\$01)	0	0	0	0	0	0	0	1
Serial Interface: Handshake Lines									
CTS	Clear To Send (\$04)	0	0	0	0	0	1	0	0
DCD	Data Carrier Detect (\$08)	0	0	0	0	1	0	0	0
DSR	Data Set Ready (\$20)	0	0	1	0	0	0	0	0
Hexadecimal & Decimal Values									
	Hexadecimal Value	\$80	\$40	\$20	\$10	\$08	\$04	\$02	\$01
	Decimal Value	128	064	032	016	008	004	002	001

IEEE 488 Bus Commands

Bus State	IEEE 488 Bus Command (ATN is asserted 1)	Data Transfer (DIO) Lines							
		8	7	6	5	4	3	2	1
DCL	Device Clear	0	0	0	1	0	1	0	0
GET	Group Execute Trigger (\$08)	0	0	0	0	1	0	0	0
GTL	Go To Local (\$01)	0	0	0	0	0	0	0	1
LAG	Listen Address Group (\$20-3F)	0	0	1	a	d	d	r	n
LLO	Local Lock Out (\$11)	0	0	0	1	0	0	0	1
MLA	My Listen Address	0	0	1	a	d	d	r	n
MTA	My Talk Address	0	1	0	a	d	d	r	n
PPC	Parallel Poll Config	0	1	1	0	S	P2	P1	P0
PPD	Parallel Poll Disable (\$07)	0	0	0	0	0	1	1	1
PPU	Parallel Poll Unconfig (\$15)	0	0	0	1	0	1	0	1
SCG	Second. Cmd. Group (\$60-7F)	0	1	1	c	o	m	m	d
SDC	Selected Device Clear (\$04)	0	0	0	0	0	1	0	0
SPD	Serial Poll Disable (\$19)	0	0	0	1	1	0	0	1
SPE	Serial Poll Enable (\$18)	0	0	0	1	1	0	0	0
TAG	Talker Address Group (\$40-5F)	0	1	0	a	d	d	r	n
TCT	Take Control (\$09)	0	0	0	0	1	0	0	1
UNL	Unlisten (\$3F)	0	0	1	1	1	1	1	1
UNT	Untalk (\$5F)	0	1	0	1	1	1	1	1
Hexadecimal & Decimal Values									
	Hexadecimal Value	\$80	\$40	\$20	\$10	\$08	\$04	\$02	\$01
	Decimal Value	128	064	032	016	008	004	002	001

ASCII Codes

ASCII Code Summary

Decimal Values 00 to 63 ACG, UCG & LAG

Box Items								
Hexadecimal Value			\$41 65 A			Decimal Value		
Bus Message			01			(in center) ASCII Character		
Addressed Command Group (ACG)								
\$00 00	\$01 01	\$02 02	\$03 03	\$04 04	\$05 05	\$06 06	\$07 07	
NUL	SOH GTL	STX	ETX	EOT SDC	ENQ	ACK	BEL PPD	
\$08 08	\$09 09	\$0A 10	\$0B 11	\$0C 12	\$0D 13	\$0E 14	\$0F 15	
BS GET	HT TCT	LF	VT	FF	CR	SO	SI	
Universal Command Group (UCG)								
\$10 16	\$11 17	\$12 18	\$13 19	\$14 20	\$15 21	\$16 22	\$17 23	
DLE	DC1 LLO	DC2	DC3	DC4 DCL	NAK PPU	SYN	ETB	
\$18 24	\$19 25	\$1A 26	\$1B 27	\$1C 28	\$1D 29	\$1E 30	\$1F 31	
CAN SPE	EM SPD	SUB	ESC	FS	GS	RS	US	
Listen Address Group (LAG)								
\$20 32	\$21 33	\$22 34	\$23 35	\$24 36	\$25 37	\$26 38	\$27 39	
SP 00	! 01	" 02	# 03	\$ 04	% 05	& 06	' 07	
\$28 40	\$29 41	\$2A 42	\$2B 43	\$2C 44	\$2D 45	\$2E 46	\$2F 47	
(08) 09	* 10	+ 11	, 12	- 13	. 14	/ 15	
\$30 48	\$31 49	\$32 50	\$33 51	\$34 52	\$35 53	\$36 54	\$37 55	
0 16	1 17	2 18	3 19	4 20	5 21	6 22	7 23	
\$38 56	\$39 57	\$3A 58	\$3B 59	\$3C 60	\$3D 61	\$3E 62	\$3F 63	
8 24	9 25	: 26	; 27	< 28	= 29	> 30	? UNL	

Decimal Values 64 to 127 TAG & SCG

Box Items															
Hexadecimal Value		\$41 65		Decimal Value											
Bus Message		01		(in center) ASCII Character											
A															
Talk Address Group (TAG)															
\$40	64	\$41	65	\$42	66	\$43	67	\$44	68	\$45	69	\$46	70	\$47	71
	@		A		B		C		D		E		F		G
00		01		02		03		04		05		06		07	
\$48	72	\$49	73	\$4A	74	\$4B	75	\$4C	76	\$4D	77	\$4E	78	\$4F	79
	H		I		J		K		L		M		N		O
08		09		10		11		12		13		14		15	
\$50	80	\$51	81	\$52	82	\$53	83	\$54	84	\$55	85	\$56	86	\$57	87
	P		Q		R		S		T		U		V		W
16		17		18		19		20		21		22		23	
\$58	88	\$59	89	\$5A	90	\$5B	91	\$5C	92	\$5D	93	\$5E	94	\$5F	95
	X		Y		Z		[\]		^		_
24		25		26		27		28		29		30		UNT	
Secondary Command Group (SCG)															
\$60	96	\$61	97	\$62	98	\$63	99	\$64	100	\$65	101	\$66	102	\$67	103
	`		a		b		c		d		e		f		g
00		01		02		03		04		05		06		07	
\$68	104	\$69	105	\$6A	106	\$6B	107	\$6C	108	\$6D	109	\$6E	110	\$6F	111
	h		i		j		k		l		m		n		o
08		09		10		11		12		13		14		15	
\$70	112	\$71	113	\$72	114	\$73	115	\$74	116	\$75	117	\$76	118	\$77	119
	p		q		r		s		t		u		v		w
16		17		18		19		20		21		22		23	
\$78	120	\$79	121	\$7A	122	\$7B	123	\$7C	124	\$7D	125	\$7E	126	\$7F	127
	x		y		z		{				}		~		DEL
24		25		26		27		28		29		30		31	

ASCII Code Details

Decimal Values 00 to 31 ACG & UCG Characteristics

ASCII Control Codes (Decimal 00 to 31)				
Dec Value	Hex Value (\$)	Character & Abbreviation	Name	Bus Message
Addressed Command Group (ACG)				
00	\$00	None / NUL	Null	None
01	\$01	^A / SOH	Start of Header	Go To Local (GTL)
02	\$02	^B / STX	Start of Text	None
03	\$03	^C / ETX	End of Text	None
04	\$04	^D / EOT	End of Transmission	Selected Device Clear (SDC)
05	\$05	^E / ENQ	Inquiry	None
06	\$06	^F / ACK	Acknowledgement	None
07	\$07	^G / BEL	Bell	Parallel Poll Disable (PPD)
08	\$08	^H / BS	Backspace	Group Execute Trigger (GET)
09	\$09	^I / HT	Horizontal Tab	Take Control (TCT)
10	\$0A	^J / LF	Line Feed	None
11	\$0B	^K / VT	Vertical Tab	None
12	\$0C	^L / FF	Form Feed	None
13	\$0D	^M / CR	Carriage Return	None
14	\$0E	^N / SO	Shift Out	None
15	\$0F	^O / SI	Shift In	None
Universal Command Group (UCG)				
16	\$10	^P / DLE	Data Link Escape	None
17	\$11	^Q / DC1	Device Control 1	Local Lockout (LLO)
18	\$12	^R / DC2	Device Control 2	None
19	\$13	^S / DC3	Device Control 3	None
20	\$14	^T / DC4	Device Control 4	Device Clear (DCL)
21	\$15	^U / NAK	Negative Acknowledgement	Parallel Poll Unconfig (PPU)
22	\$16	^V / SYN	Synchronous Idle	None
23	\$17	^W / ETB	End of Transmission Block	None
24	\$18	^X / CAN	Cancel	Serial Poll Enable (SPE)
25	\$19	^Y / EM	End of Medium	Serial Poll Disable (SPD)
26	\$1A	^Z / SUB	Substitute	None
27	\$1B	^[/ ESC	Escape	None
28	\$1C	^ \ / FS	File Separator	None
29	\$1D	^] / GS	Group Separator	None
30	\$1E	^^ / RS	Record Separator	None
31	\$1F	^_ / US	Unit Separator	None

Note: (1) ASCII control codes are sometimes used to “formalize” a communications session between communication devices. (2) DC1, DC2, DC3, DC4, FS, GS, RS, and US all have user-defined meanings, and may vary in use between sessions or devices. (3) DC4 is often used as a general “stop transmission character.” (4) Codes used to control cursor position may be used to control print devices, and move the print head accordingly. However, not all devices support the full set of positioning codes.

Decimal Values 00 to 31 ACG & UCG Descriptions

ASCII Control Codes (00 to 31)		
Dec	Name	Description
Addressed Command Group (ACG)		
00	Null (NUL)	Space filler character. Used in output timing for some device drivers.
01	Start of Header (SOH)	Marks beginning of message header.
02	Start of Text (STX)	Marks beginning of data block (text).
03	End of Text (ETX)	Marks end of data block (text).
04	End of Transmission (EOT)	Marks end of transmission session.
05	Inquiry (ENQ)	Request for identification or information.
06	Acknowledgement (ACK)	"Yes" answer to questions or "ready for next transmission." Used in asynchronous protocols for timing.
07	Bell (BEL)	Rings bell or audible alarm on terminal.
08	Backspace (BS)	Moves cursor position back one character.
09	Horizontal Tab (HT)	Moves cursor position to next tab stop on line.
10	Line Feed (LF)	Moves cursor position down one line.
11	Vertical Tab (VT)	Moves cursor position down to next "tab line."
12	Form Feed (FF)	Moves cursor position to top of next page.
13	Carriage Return (CR)	Moves cursor to left margin.
14	Shift Out (SO)	Next characters do not follow ASCII definitions.
15	Shift In (SI)	Next characters revert to ASCII meaning.
Universal Command Group (UCG)		
16	Data Link Escape (DLE)	Used to control transmissions using "escape sequences."
17	Device Control 1 (DC1)	Not defined. Normally used for ON controls.
18	Device Control 2 (DC2)	Usually user-defined.
19	Device Control 3 (DC3)	Not defined. Normally used for OFF controls.
20	Device Control 4 (DC4)	Usually user-defined.
21	Negative Acknowledgement (NAK)	"No" answer to questions or "errors found, re-transmit." Used in asynchronous protocols for timing.
22	Synchronous Idle (SYN)	Sent by asynchronous devices when idle to insure sync.
23	End of Transmission Block (ETB)	Marks block boundaries in transmission.
24	Cancel (CAN)	Indicates previous transmission should be disregarded.
25	End of Medium (EM)	Marks end of physical media, as in paper tape.
26	Substitute (SUB)	Used to replace a character known to be wrong.
27	Escape (ESC)	Marks beginning of an Escape control sequence.
28	File Separator (FS)	Marker for major portion of transmission.
29	Group Separator (GS)	Marker for submajor portion of transmission.
30	Record Separator (RS)	Marker for minor portion of transmission.
31	Unit Separator (US)	Marker for most minor portion of transmission.

Note: (1) ASCII control codes are sometimes used to "formalize" a communications session between communication devices. (2) **DC1**, **DC2**, **DC3**, **DC4**, **FS**, **GS**, **RS**, and **US** all have user-defined meanings, and may vary in use between sessions or devices. (3) **DC4** is often used as a general "stop transmission character." (4) Codes used to control cursor position may be used to control print devices, and move the print head accordingly. However, not all devices support the full set of positioning codes.

Decimal Values 32 to 63 LAG

ASCII Character Set (Decimal 32 to 63)				
Dec	Hex	Character	Name	Bus Message
Listen Address Group (LAG)				
32	\$20	<space>	Space	Bus address 00
33	\$21	!	Exclamation Point	Bus address 01
34	\$22	"	Quotation Mark	Bus address 02
35	\$23	#	Number Sign	Bus address 03
36	\$24	\$	Dollar Sign	Bus address 04
37	\$25	%	Percent Sign	Bus address 05
38	\$26	&	Ampersand	Bus address 06
39	\$27	'	Apostrophe	Bus address 07
40	\$28	(Opening Parenthesis	Bus address 08
41	\$29)	Closing Parenthesis	Bus address 09
42	\$2A	*	Asterisk	Bus address 10
43	\$2B	+	Plus Sign	Bus address 11
44	\$2C	,	Comma	Bus address 12
45	\$2D	-	Hyphen or Minus Sign	Bus address 13
46	\$2E	.	Period	Bus address 14
47	\$2F	/	Slash	Bus address 15
Listen Address Group (LAG)				
48	\$30	0	Zero	Bus address 16
49	\$31	1	One	Bus address 17
50	\$32	2	Two	Bus address 18
51	\$33	3	Three	Bus address 19
52	\$34	4	Four	Bus address 20
53	\$35	5	Five	Bus address 21
54	\$36	6	Six	Bus address 22
55	\$37	7	Seven	Bus address 23
56	\$38	8	Eight	Bus address 24
57	\$39	9	Nine	Bus address 25
58	\$3A	:	Colon	Bus address 26
59	\$3B	;	Semicolon	Bus address 27
60	\$3C	<	Less Than Sign	Bus address 28
61	\$3D	=	Equal Sign	Bus address 29
62	\$3E	>	Greater Than Sign	Bus address 30
63	\$3F	?	Question Mark	Unlisten (UNL)

Decimal Values 64 to 95 TAG

ASCII Character Set (Decimal 64 to 95)				
Dec	Hex	Character	Name	Bus Message
Talk Address Group (TAG)				
64	\$40	@	At Sign	Bus address 00
65	\$41	A	Capital A	Bus address 01
66	\$42	B	Capital B	Bus address 02
67	\$43	C	Capital C	Bus address 03
68	\$44	D	Capital D	Bus address 04
69	\$45	E	Capital E	Bus address 05
70	\$46	F	Capital F	Bus address 06
71	\$47	G	Capital G	Bus address 07
72	\$48	H	Capital H	Bus address 08
73	\$49	I	Capital I	Bus address 09
74	\$4A	J	Capital J	Bus address 10
75	\$4B	K	Capital K	Bus address 11
76	\$4C	L	Capital L	Bus address 12
77	\$4D	M	Capital M	Bus address 13
78	\$4E	N	Capital N	Bus address 14
79	\$4F	O	Capital O	Bus address 15
Talk Address Group (TAG)				
80	\$50	P	Capital P	Bus address 16
81	\$51	Q	Capital Q	Bus address 17
82	\$52	R	Capital R	Bus address 18
83	\$53	S	Capital S	Bus address 19
84	\$54	T	Capital T	Bus address 20
85	\$55	U	Capital U	Bus address 21
86	\$56	V	Capital V	Bus address 22
87	\$57	W	Capital W	Bus address 23
88	\$58	X	Capital X	Bus address 24
89	\$59	Y	Capital Y	Bus address 25
90	\$5A	Z	Capital Z	Bus address 26
91	\$5B	[Opening Bracket	Bus address 27
92	\$5C	\	Backward Slash	Bus address 28
93	\$5D]	Closing Bracket	Bus address 29
94	\$5E	^	Caret	Bus address 30
95	\$5F	_	Underscore	Untalk (UNT)

Decimal Values 96 to 127 SCG

ASCII Character Set (96 to 127)				
Dec	Hex	Character	Name	Bus Message
Secondary Command Group (SCG)				
96	\$60	'	Grave	Command 00
97	\$61	a	Lowercase A	Command 01
98	\$62	b	Lowercase B	Command 02
99	\$63	c	Lowercase C	Command 03
100	\$64	d	Lowercase D	Command 04
101	\$65	e	Lowercase E	Command 05
102	\$66	f	Lowercase F	Command 06
103	\$67	g	Lowercase G	Command 07
104	\$68	h	Lowercase H	Command 08
105	\$69	I	Lowercase I	Command 09
106	\$6A	j	Lowercase J	Command 10
107	\$6B	k	Lowercase K	Command 11
108	\$6C	l	Lowercase L	Command 12
109	\$6D	m	Lowercase M	Command 13
110	\$6E	n	Lowercase N	Command 14
111	\$6F	o	Lowercase O	Command 15
Secondary Command Group (SCG)				
112	\$70	p	Lowercase P	Command 16
113	\$71	q	Lowercase Q	Command 17
114	\$72	r	Lowercase R	Command 18
115	\$73	s	Lowercase S	Command 19
116	\$74	t	Lowercase T	Command 20
117	\$75	u	Lowercase U	Command 21
118	\$76	v	Lowercase V	Command 22
119	\$77	w	Lowercase W	Command 23
120	\$78	x	Lowercase X	Command 24
121	\$79	y	Lowercase Y	Command 25
122	\$7A	z	Lowercase Z	Command 26
123	\$7B	{	Opening Brace	Command 27
124	\$7C		Vertical Line	Command 28
125	\$7D	}	Closing Brace	Command 29
126	\$7E	~	Tilde	Command 30
127	\$7F	DEL	Delete	Command 31



Notes

Index

A

absolute time, 186
accessories
 hardware, 3
acquisition, 177, 244, 248, 260, 264, 272
Acquisition Buffer, 197, 198, 199, 201, 202, 203, 204, 205, 206, 260, 264, 287, 324
alarm, 16, 183, 184, 252, 256, 297
alarm stamping, 187, 188, 298
ASCII, 192, 194, 332
Auto Re-arm, 198, 268

B

baud rate, 20
bench top, 53
binary, 193
Binary format, 193, 260, 264
buffer, 197
buffer overrun, 207
burst mode, 169, 272, 308

C

CA-47, 3
CA-7-3, 3
cables, 3
calibration, 17, 290, 291, 292, 304, 309, 310, 313, 314, 323
 cold junction, 234
 gain, 229, 233, 236, 237
 master chassis, 228, 229
 offset, 229, 232, 236, 237
 password, 227
 properties, 157, 225
 protection, 23, 158, 226
 ScanCal, 159
 scanning card, 230, 232, 236, 237
 setup, 157, 225
 status, 226
Calibration Status Register (CSR), 216
case sensitivity, 276
CAUTION, 6, 14, 15, 16, 23, 24, 29, 30, 31, 35, 36, 37, 51, 52, 158, 167, 171, 185, 226, 229, 232, 233, 234, 236, 237
channel, 14, 26, 56, 147, 171, 172, 174, 288, 299, 303, 309, 310
channel assignment, 31, 37
character, 276
chart, 56, 147
ChartView
 Acquire menu, 73
 Acquisition Setup dialog box, 88
 Alarm Configuration columns, 88
 Analog Meters, 81

 Arm Acquisition option, 69
 Auto Re-arm option, 91, 92
 Automatic Chart Creation
 option, 94
 Bar Graph Meters, 80
 Channel & Alarm Setup dialog
 box, 85
 Channel Configuration columns, 87
 Channel Configuration option, 69
 Channel Information region, 60
 Chart menu, 71
 Chart Setup Wizard, 93
 Data Destination dialog box, 91
 Data menu, 73
 Device menu, 76, 77
 Device menu (expanded), 79
 Digital Meters, 82
 Disarm option, 69
 Display Configuration Setup
 option, 63
 File menu, 70
 Group Select option, 62
 Main Window, 58
 Manual Chart Creation option, 95
 manually creating a display, 66
 manually editing a display, 64
 Meters, 80
 Meters Configuration pop-up
 menu, 84
 Meters pull-down menus, 83
 Meters toolbars, 83
 operation, 56
 Pause option, 62
 PostView option, 69
 Print Charts option, 70
 pull-down menus, 70
 Scroll Faster option, 63
 Scroll Slower option, 63
 Setup menu, 79
 Setup window, 85
 Start option, 62
 Status Indicator region, 61
 Stop option, 62
 toolbar, 62
 View menu, 72
 Window menu, 75
Clear, 211, 287, 288
clock, 222, 326
cold-junction calibration, 234
cold-junction compensation, 313
command
 banner, 285
 case sensitivity, 276
 character, 276
 conflict error, 277
 deferred, 277
 description format, 285
 Execute, 276, 334

 execution, 285
 fixed formats, 277
 immediate, 277
 interpretation, 277
 multiple parameters, 276
 reference, 285
 string, 276
 summary, 280
 syntax, 276
 Type, 285
 white spaces, 276

common mode, 168

configuration

 acquisition, 177
 additional, 182
 alarm, 183
 channel, 171, 288, 299
 data format, 190, 306
 digital I/O, 185
 hardware, 17, 30, 36
 power-up, 196, 294
 required, 170
 scan, 173
 stamp, 186
 Trigger, 180, 327

configuration file, 97

conflict error, 277

connector, 13, 21, 28, 34

count, 192, 194, 335

Counts format, 194

D

data format, 15, 190, 191, 306
deferred command, 277, 278, 279, 285, 334
digital alarm, 184, 297
digital filtering, 223, 296
digital I/O, 16, 23, 184, 185, 188, 297, 312, 320
digital input stamping, 188, 189, 312
DIP switch, 13, 18, 20, 28, 34, 158
disposition, 174

E

Engineering Units format, 192
error, 223, 277, 305
error checking, 223
Error Source Register (ESC), 217
event, 180, 181, 319
Event Status Enable Register (ESE), 220
Event Status Register (ESR), 218
Execute, 276, 334
execution order, 279
Exp/10A, 2, 3
 connection, 30
Exp/11A, 2, 3
 connection, 36
expanded memory, 25

expansion, 26
 channel, 26
 scanning card, 26
expansion unit, 2, 3

F

factory default, 289
factory settings, 289
fast mode, 174
filtering, 223, 296
fixed format, 277
frequency, 308
front panel, 12, 27, 33
fuse, 49, 52

G

gain, 290, 309
gain calibration, 229, 233, 236, 237
gap-free acquisition, 179
group, 56, 147

H

handshaking, 20
hardware
 connections, 4, 6, 8
 products, 1
High/Low/Last (HLL) Registers,
 209, 210, 211, 240, 242, 325
high-voltage, 48, 172
hysteresis, 183

I

IEEE 488, 15, 18, 256
immediate command, 277, 278, 285
input data, 190

J

jumper, 18

K

keyword, 291

L

latency, 222
LED indicator, 12, 27, 33
line voltage, 49, 50, 52
line-cycle integration / high-speed
 multi-channel mode, 167, 168,
 333

M

Mask Registers, 214, 215, 220, 317,
 319
master, 30, 36, 228
master/slave, 30, 34, 36
measuring mode, 318
measuring modes, 166
memory, 25, 166, 335
 installation, 25
MHV/24, 48, 172
MTC/24, 46, 172

MultiMEM1, 3
MultiMEM4, 3
MultiMEM8, 3
multiple parameters, 276
MultiScan/1100, 1

N

noise filtering, 167, 223

O

offset, 310, 313
offset calibration, 229, 232, 236, 237
output data, 191, 195, 322, 332
overrun, 199, 207

P

package, 11, 27, 33
parity, 20
password, 291
pin connector, 21
Post-Stop, 178, 335
Post-Trigger, 178, 244, 248, 335
PostView, 9
 Automatic Chart Creation
 option, 148
 Channel Information region, 145
 Chart Setup Wizard, 147
 data file accessibility, 155
 Display Configuration Setup
 dialog box, 149
 File menu, 146
 Go To menu, 146
 Help menu, 146
 manually creating a display, 152
 manually editing a display, 150
 Options menu, 146
 pull-down menus, 146
 Startup, 143
 timebase, 155
 toolbar, 144
power-on, 54, 196, 293, 294
power-up, 54, 196, 293, 294
Pre-Trigger, 177, 244, 248, 335

Q

Query, 199, 202, 203, 210, 211, 212,
 213, 305, 322, 323, 329, 336

R

rack mount, 53
range error, 223
Read, 201, 204, 205, 206, 213, 240,
 242, 324, 325
real-time clock, 222, 326
rear panel, 13, 28, 34
register, 209, 214
register hierarchy, 221
relative time, 186
relay, 303
RS-232/RS-422, 15, 18
RTD, 44, 172, 237, 290

S

sampling weight, 167, 333
scan, 173, 295, 298
scan interval, 167, 173, 174, 175,
 176, 185, 214, 244, 248, 308, 311,
 316
ScanCal, 9
 About option, 161
 Calibrate menu, 163
 Calibrate Selected Devices
 option, 163
 Exit option, 161
 File menu, 161
 Instructions area, 160
 Instrument menu, 162
 interface parameters, 160
 inventory, 160
 Inventory Display area, 160
 Inventory Instrument System
 option, 162
 Main Window, 159
 Open Interface Parameters
 option, 161
 post-calibration, 160
 Save Interface Parameters
 option, 161
 Setup Interface Parameters
 option, 162
 Take Inventory option, 162
 Upload Cal Constants option,
 164
scanning card, 2, 26, 40, 42, 44, 46,
 48, 172, 302, 323
serial, 15, 18, 19, 21
Service Request, 317
Service Request Enable Register
 (SRE), 220
setpoint, 183
single-channel high-speed burst
 mode, 169, 272, 308
slave, 30, 31, 36, 37
software, 9
specifications, 14, 40, 42, 44, 46, 48
 alarm, 16
 calibration, 17
 channel, 14
 data format, 15
 digital I/O, 16
 Exp/10A, 29
 Exp/11A, 35
 general, 16
 IEEE 488, 15
 MHV/24, 48
 MTC/24, 46
 MultiScan/1200, 14
 serial, 15
 TempRTD/16A, 44
 TempScan/1100, 14
 TempTC/32B, 40
 TempV/32A, 42
 trigger, 14
stamping, 186
Status Byte Register (STB), 219

Status-Reporting Registers, 214,
215, 216, 220
Stop, 180, 181
string, 276
switch, 13, 28, 34
syntax, 276

T

TempMEM1, 3
TempMEM4, 3
TempMEM8, 3
TempRTD/16A, 44, 172
TempScan/1100, 1
TempTC/32B, 40, 172
TempV/32A, 42, 172
TempView, 9
 About option, 109
 Acquire menu, 111
 Acquisition Configuration, 100,
 111
 Acquisition Status option, 115
 Alarms menu, 127
 Analog Meters option, 121
 Arm Acquisition option, 111
 Bar Graph Meters option, 121
 CH column, 104
 Channel Configuration area, 103
 Channel Display area, 132
 Charts, 129
 Charts option, 121
 Check Alarm Status option, 128
 Configure Acquisition option,
 111
 Configure Alarms option, 127
 Configure Meter pop-up menu,
 137
 Control menu, 133
 Data File Parameters option, 119
 Data menu, 117
 DDE Configuration for Excel
 option, 117
 Device menu (expanded), 125
 Digital Filtering option, 125
 Digital Meters option, 121
 Disarm option, 111
 Edit menu, 110
 Enable Slow Scan Rate option,
 125
 Enable Spreadsheet Reading
 option, 116
 Exit option, 109
 Faster option, 134
 File menu, 108
 Fill Down option, 110
 Go Down to Next Available
 Channel option, 110
 Go to Channel option, 110
 Go Up to Next Available
 Channel option, 110
 Instrument Error Status option,
 124
 Instrument Inventory option, 123
 Instrument Realtime Clock
 option, 124
 Label column, 105
 Linearized CJC only option, 126
 Linearized Thermocouple w/o
 CJC option, 126
 Link to Excel option, 118
 Main Window, 102
 Make All Channel Active
 option, 110
 Make All Channel Inactive
 option, 110
 Meters, 129
 New option, 108
 Number of Charts option, 135
 Number of Meters option, 136
 On column, 104
 Open option, 108
 Options menu, 135
 Pause option, 133
 PostView option, 121
 Print Charts option, 135
 Print option, 109, 136
 Properties option, 139
 Raw Temperature Sensor Input
 option, 126
 Raw Thermocouple Input
 option, 126
 Reading column, 106
 Reset Peak Hold Indicator
 option, 138
 Reset Peak Hold option, 133
 Rows x Columns option, 136
 Save As option, 109
 Save option, 109
 Select Channel option, 137
 Set Limits option, 139
 Set Scale option, 138
 Setup, 98, 100
 Setup IEEE 488 option, 122
 Setup RS-232 option, 122
 Show Grids option, 135
 Show Limits option, 139
 Show Peak Hold Indicator
 option, 138
 Show Trend Indicator option,
 138
 Simulated Instrument option,
 123
 Slower option, 134
 Speed menu, 134
 Start All Indicators option, 116
 Startup, 98
 Status area, 107
 Stay On Top option, 135, 136
 Stop All Indicators option, 116
 Stop option, 133
 Stop Upload option, 119
 System State area, 107
 Type column, 104
 Units column, 105
 Upload Available Scans option,
 119
 Upload Data During Acquisition
 option, 119
 Upload Scans Until Done
 option, 119
 View menu, 136
 Window menu, 121
terminator, 195, 210, 212, 213, 322,
332
thermocouple, 40, 46, 172, 223, 232,
233, 234, 242
time stamping, 186, 187, 295
timebase, 179
trigger, 14, 24
Trigger, 180, 181, 286, 321, 327
Trigger Block, 198, 199, 202, 203,
204, 205, 206, 207, 268
trigger latency, 222
trigger level, 315
Trigger overrun, 199
trigger source, 181, 222
Trigger time, 321
TTL, 24

V

volt, 172, 242
voltage, 42, 46, 48, 236

W

WARNING, 6, 16, 19, 25, 29, 35,
49, 50, 52
weight, 167, 333
white spaces, 276

Abbreviations

•	(bullet symbol) "and" (e.g. *SC•CA)	FCC	Federal Communications Commission
*	(asterisk symbol) "unasserted" (e.g. *SC)	FF	Form Feed (ASCII Code)
*CA	Not Controller Active mode	FS	File Separator (ASCII Code)
*SC	Not System Controller mode	GET	Group Execute Trigger bus command
A/D	Analog-to-Digital	GPIB	General Purpose Interface Bus
ACG	Addressed Command Group	GS	Group Separator (ASCII Code)
ACK	Acknowledgement (ASCII Code)	GTL	Go To Local bus command
ADC	Analog-to-Digital Converter	GUI	Graphical User Interface
API	Application Program Interface	H/W	Hardware
ASCII	American Standard Code for Info. Interchange	HT	Horizontal Tab (ASCII Code)
ATN	Attention line	IDDC	Invalid Device Dependent Command
BEL	Bell (ASCII Code)	IDDCO	Invalid Device Dependent Command Option
BS	Backspace (ASCII Code)	IEEE	Institute of Electrical & Electronic Engineers
CA	Controller Active mode	IFC	Interface Clear line
CAN	Cancel (ASCII Code)	IOCTL	Input/Output Control
CCL	Character Command Language	ISA	Industry Standard Architecture bus
CJC	Cold Junction Compensation	ISR	Interrupt Service Routine
CMD	Bus Command interpretation	ist	Bus Device Individual Status
CR	Carriage Return (ASCII Code)	LAG	Listen Address Group bus command
CSR	Calibration Status Register	LED	Light-Emitting Diode
CTS	Clear To Send line	LF	Line Feed (ASCII Code)
DAV	Data Valid line	LLO	Local Lock Out bus command
DC1	Device Control 1 (ASCII Code)	LSB	Least Significant Bit
DC2	Device Control 2 (ASCII Code)	MAV	Message Available bit
DC3	Device Control 3 (ASCII Code)	MLA	My Listen Address
DC4	Device Control 4 (ASCII Code)	MSB	Most Significant Bit
DCD	Data Carrier Detect line	MSS	Master Summary Status bit
DCL	Device Clear bus command	MTA	My Talk Address
DDE	Dynamic Data Exchange	N/U	Not Used
DEL	Delete (ASCII Code)	NAK	Negative Acknowledgement (ASCII Code)
DIO	Data Transfer (I/O) line	NDAC	Not Data Accepted line
DLE	Data Link Escape (ASCII Code)	NRFD	Not Ready For Data line
DLL	Dynamic Link Library	NUL	Null (ASCII Code)
DMA	Direct Memory Access	NV-RAM	Non-Volatile RAM
DMM	Digital Multimeter	PCI	Peripheral Component Interconnect bus
DSR	Data Set Ready line	PPC	Parallel Poll Configure bus command
DTR	Data Terminal Ready line	PPD	Parallel Poll Disable bus command
EEPROM	Electrically Erasable Programmable ROM	PPU	Parallel Poll Unconfig bus command
EM	End of Medium (ASCII Code)	RAM	Random-Access Memory
ENQ	Inquiry (ASCII Code)	REN	Remote Enable line
EOI	End-Or-Identify line	RI	Ring Indicator line
EOL	End-Of-Line terminator	RMS	Root Mean Square
EOT	End of Transmission (ASCII Code)	ROM	Read-Only Memory
EPROM	Erasable Programmable ROM	RQS	Request for Service bit
ESB	Event Status Register bit	RS	Record Separator (ASCII Code)
ESC	Error Source Register	RS-	Revised Standard (e.g. RS-232, RS-422)
ESC	Escape (ASCII Code)	rsv	Request for Service bit
ESE	Event Status Enable Register	RTD	Resistance Temperature Device
ESR	Event Status Register	RTS	Request To Send line
ETB	End of Transmission Block (ASCII Code)	SC	System Controller mode
ETX	End of Text (ASCII Code)	SCG	Secondary Command Group

SCPI	Standard Ccmds. for Programmable Instruments	SUB	Substitute (ASCII Code)
SCSI	Small Computer System Interface bus	SYN	Synchronous Idle (ASCII Code)
SDC	Selected Device Clear bus command	T/C	Thermocouple
SI	Shift In (ASCII Code)	TAG	Talk Address Group bus command
SO	Shift Out (ASCII Code)	TCT	Take Control bus command
SOH	Start of Header (ASCII Code)	TTL	Transistor-Transistor Logic
SPD	Serial Poll Disable bus command	UCG	Universal Command Group
SPE	Serial Poll Enable bus command	UNL	Unlisten bus command
SRE	Service Request Enable Register	UNT	Untalk bus command
SRQ	Service Request line	US	Unit Separator (ASCII Code)
STB	Status Byte Register	VDM	Virtual DOS Machine
STX	Start of Text (ASCII Code)	VT	Vertical Tab (ASCII Code)



Notes



WARRANTY/DISCLAIMER

OMEGA ENGINEERING, INC. warrants this unit to be free of defects in materials and workmanship for a period of **13 months** from date of purchase. OMEGA Warranty adds an additional one (1) month grace period to the normal **one (1) year product warranty** to cover handling and shipping time. This ensures that OMEGA's customers receive maximum coverage on each product.

If the unit should malfunction, it must be returned to the factory for evaluation. OMEGA's Customer Service Department will issue an Authorized Return (AR) number immediately upon phone or written request. Upon examination by OMEGA, if the unit is found to be defective it will be repaired or replaced at no charge. OMEGA's WARRANTY does not apply to defects resulting from any action of the purchaser, including but not limited to mishandling, improper interfacing, operation outside of design limits, improper repair, or unauthorized modification. This WARRANTY is VOID if the unit shows evidence of having been tampered with or shows evidence of being damaged as a result of excessive corrosion; or current, heat, moisture or vibration; improper specification; misapplication; misuse or other operating conditions outside of OMEGA's control. Components which wear are not warranted, including but not limited to contact points, fuses, and triacs.

OMEGA is pleased to offer suggestions on the use of its various products. However, OMEGA neither assumes responsibility for any omissions or errors nor assumes liability for any damages that result from the use of its products in accordance with information provided by OMEGA, either verbal or written. OMEGA warrants only that the parts manufactured by it will be as specified and free of defects. OMEGA MAKES NO OTHER WARRANTIES OR REPRESENTATIONS OF ANY KIND WHATSOEVER, EXPRESSED OR IMPLIED, EXCEPT THAT OF TITLE, AND ALL IMPLIED WARRANTIES INCLUDING ANY WARRANTY OF MERCHANTABILITY AND FITNESS FOR A PARTICULAR PURPOSE ARE HEREBY DISCLAIMED. LIMITATION OF LIABILITY: The remedies of purchaser set forth herein are exclusive and the total liability of OMEGA with respect to this order, whether based on contract, warranty, negligence, indemnification, strict liability or otherwise, shall not exceed the purchase price of the component upon which liability is based. In no event shall OMEGA be liable for consequential, incidental or special damages.

CONDITIONS: Equipment sold by OMEGA is not intended to be used, nor shall it be used: (1) as a "Basic Component" under 10 CFR 21 (NRC), used in or with any nuclear installation or activity; or (2) in medical applications or used on humans. Should any Product(s) be used in or with any nuclear installation or activity, medical application, used on humans, or misused in any way, OMEGA assumes no responsibility as set forth in our basic WARRANTY/DISCLAIMER language, and additionally, purchaser will indemnify OMEGA and hold OMEGA harmless from any liability or damage whatsoever arising out of the use of the Product(s) in such a manner.

RETURN REQUESTS/INQUIRIES

Direct all warranty and repair requests/inquiries to the OMEGA Customer Service Department. BEFORE RETURNING ANY PRODUCT(S) TO OMEGA, PURCHASER MUST OBTAIN AN AUTHORIZED RETURN (AR) NUMBER FROM OMEGA'S CUSTOMER SERVICE DEPARTMENT (IN ORDER TO AVOID PROCESSING DELAYS). The assigned AR number should then be marked on the outside of the return package and on any correspondence.

The purchaser is responsible for shipping charges, freight, insurance and proper packaging to prevent breakage in transit.

FOR **WARRANTY** RETURNS, please have the following information available BEFORE contacting OMEGA:

1. P.O. number under which the product was PURCHASED,
2. Model and serial number of the product under warranty, and
3. Repair instructions and/or specific problems relative to the product.

FOR **NON-WARRANTY** REPAIRS, consult OMEGA for current repair charges. Have the following information available BEFORE contacting OMEGA:

1. P.O. number to cover the COST of the repair,
2. Model and serial number of the product, and
3. Repair instructions and/or specific problems relative to the product.

OMEGA's policy is to make running changes, not model changes, whenever an improvement is possible. This affords our customers the latest in technology and engineering.

OMEGA is a registered trademark of OMEGA ENGINEERING, INC.

© Copyright 1996 OMEGA ENGINEERING, INC. All rights reserved. This document may not be copied, photocopied, reproduced, translated, or reduced to any electronic medium or machine-readable form, in whole or in part, without prior written consent of OMEGA ENGINEERING, INC.

Where Do I Find Everything I Need for Process Measurement and Control? OMEGA...Of Course!

TEMPERATURE

- Thermocouple, RTD & Thermistor Probes, Connectors, Panels & Assemblies
- Wire: Thermocouple, RTD & Thermistor
- Calibrators & Ice Point References
- Recorders, Controllers & Process Monitors
- Infrared Pyrometers

PRESSURE, STRAIN AND FORCE

- Transducers & Strain Gauges
- Load Cells & Pressure Gauges
- Displacement Transducers
- Instrumentation & Accessories

FLOW/LEVEL

- Rotameters, Gas Mass Flowmeters & Flow Computers
- Air Velocity Indicators
- Turbine/Paddlewheel Systems
- Totalizers & Batch Controllers

pH/CONDUCTIVITY

- pH Electrodes, Testers & Accessories
- Benchtop/Laboratory Meters
- Controllers, Calibrators, Simulators & Pumps
- Industrial pH & Conductivity Equipment

DATA ACQUISITION

- Data Acquisition & Engineering Software
- Communications-Based Acquisition Systems
- Plug-in Cards for Apple, IBM & Compatibles
- Datalogging Systems
- Recorders, Printers & Plotters

HEATERS

- Heating Cable
- Cartridge & Strip Heaters
- Immersion & Band Heaters
- Flexible Heaters
- Laboratory Heaters

ENVIRONMENTAL MONITORING AND CONTROL

- Metering & Control Instrumentation
- Refractometers
- Pumps & Tubing
- Air, Soil & Water Monitors
- Industrial Water & Wastewater Treatment
- pH, Conductivity & Dissolved Oxygen Instruments